

POLSKI

РУССКИЙ

SVENSKA

NEDERLANDS

ESPAÑOL

ITALIANO

FRANÇAIS

DEUTSCH

ENGLISH

DENON

AVR-4520

INTEGRATED NETWORK AV RECEIVER

Getting Started

Erste Schritte / Mise en route / Guida introduttiva / Antes de empezar / Aan de slag / Att komma igång / Начало работы / Skrócona instrukcja obsługi

Welcome

Thank you for choosing a DENON receiver. This guide provides step-by-step instructions for setting up your receiver.

If you have setup problems:

If you need additional help in solving problems, contact DENON customer service in your area.

See the address sheet included in the box.

Before You Begin

What's In the Box

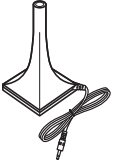
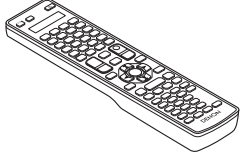
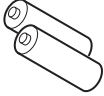
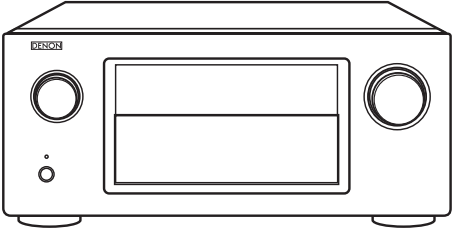
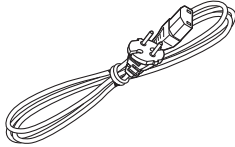
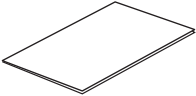
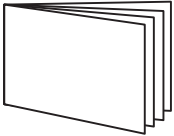
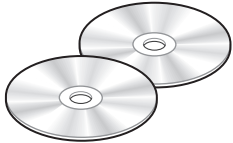
 <p>Setup microphone</p>	 <p>Remote control unit</p>	 <p>LR6/AA batteries</p>
 <p>Receiver</p>		 <p>Power cord</p>
 <p>Safety Instructions</p>	 <p>Getting Started</p>	 <p>Owner's Manual</p>

Required for setup

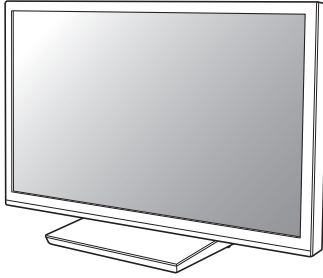
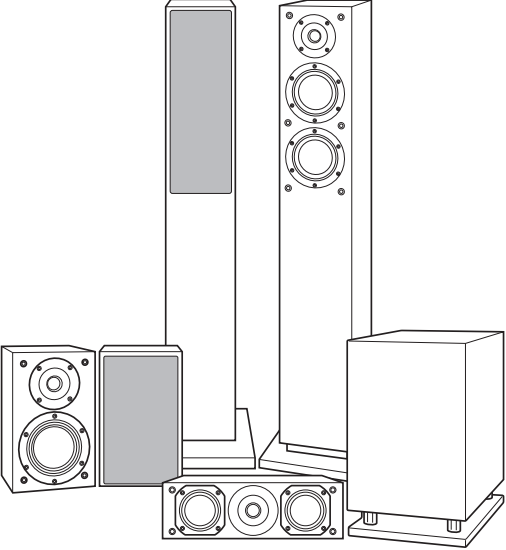
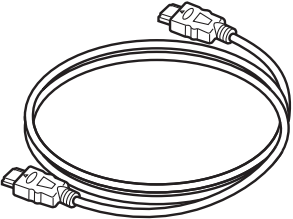
 <p>TV</p>	 <p>Speaker systems</p>
 <p>HDMI cable</p>	



These drawings are for illustrative purposes only and may not represent the actual product(s).

Setup Steps

There are three steps to the setup process.

1 Install batteries in the remote control unit

2 Connect the receiver to your TV

3 Follow the On-Screen Setup Assistant

1 Installing batteries in the remote control unit

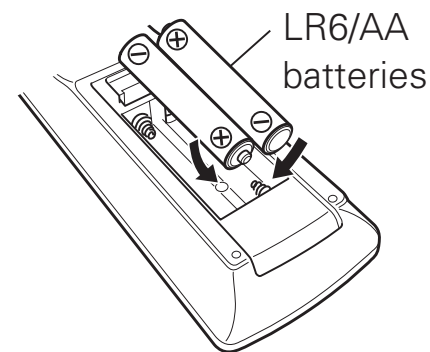
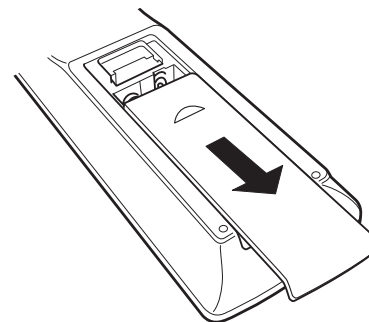

2 Connecting the receiver to your TV

□ Place the receiver near your TV.

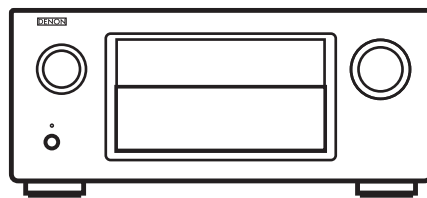
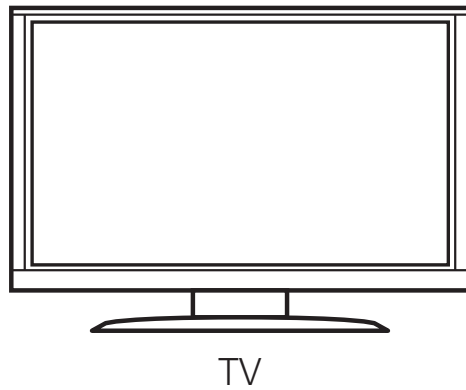

□ Connect the receiver to your TV with an HDMI cable.

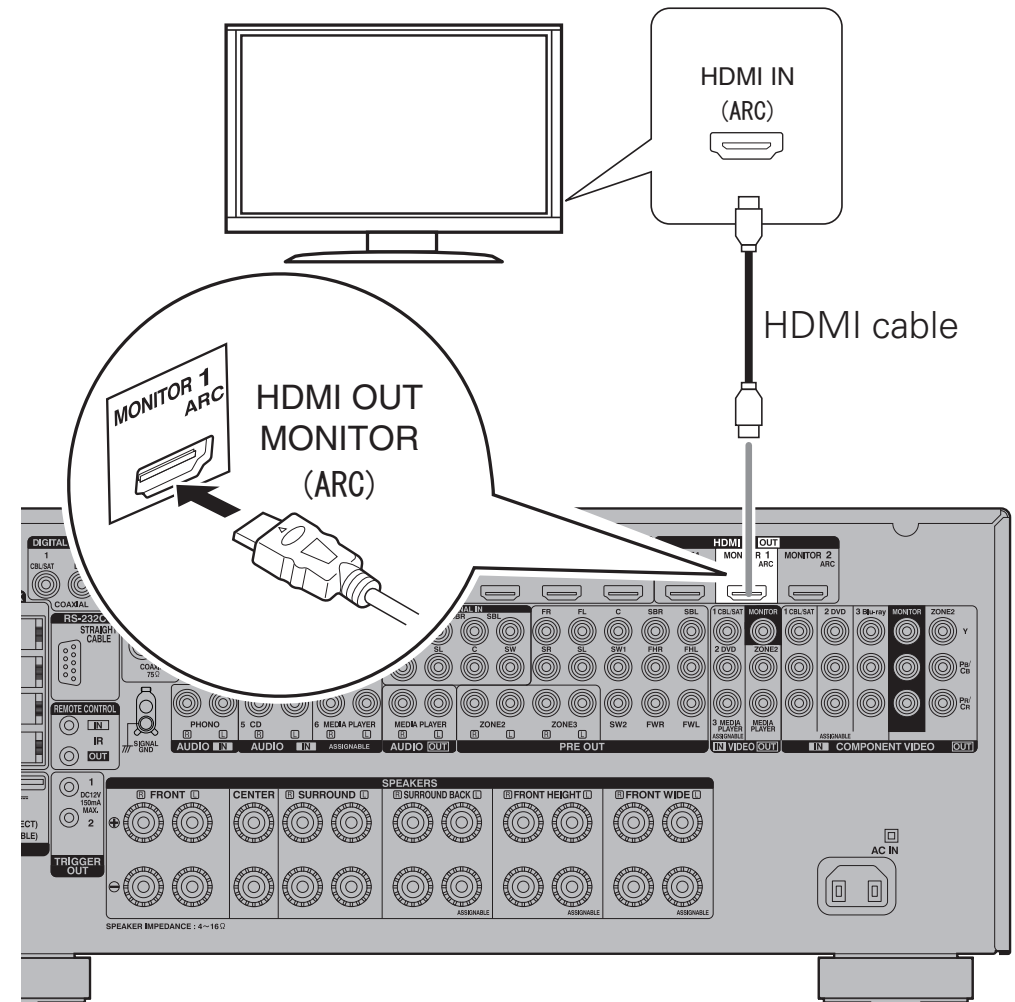

❑ Turn on the TV.

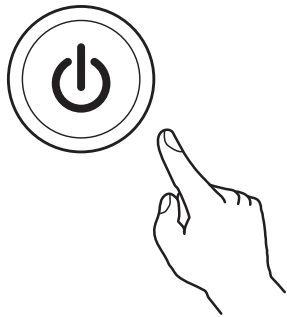
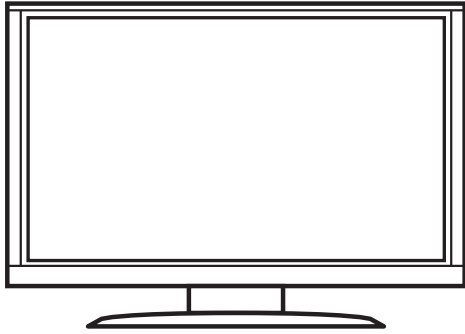

TV remote control unit

❑ Select the appropriate HDMI input on your TV.

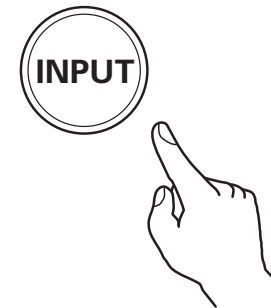
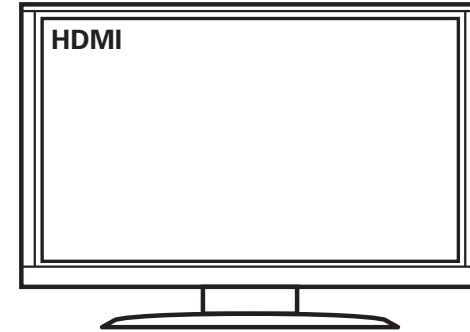

TV remote control unit

❑ Turn on receiver.

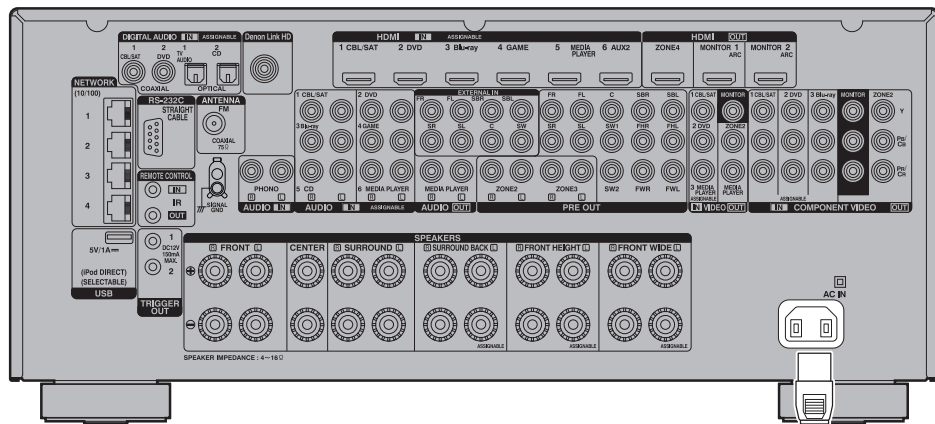

Connect to household power outlet
(AC 230 V, 50/60 Hz)

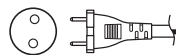

Power cord
(supplied)

- Turn on receiver as shown below.

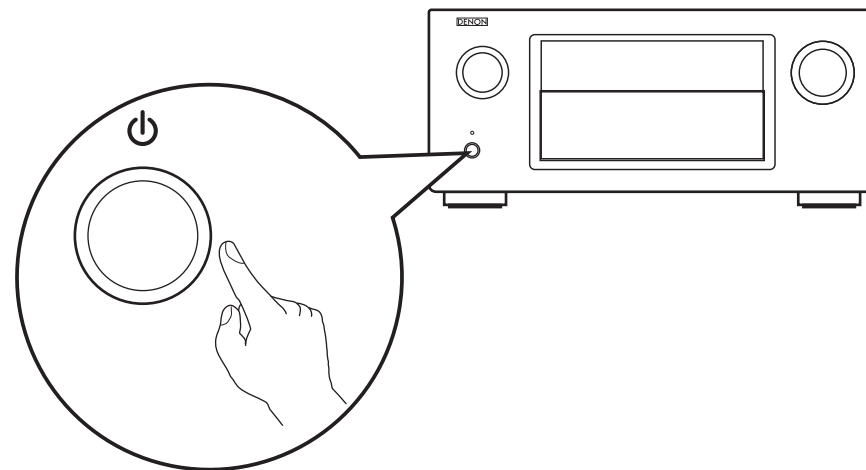

3 Follow the On-Screen Setup Assistant

The Setup Assistant will walk you through connecting and configuring your speakers and components to your DENON receiver. Please use the remote control and follow the on-screen instructions.

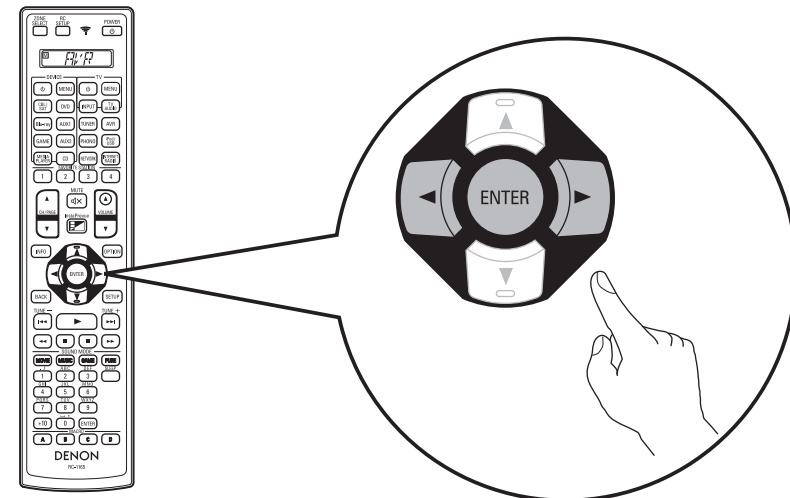
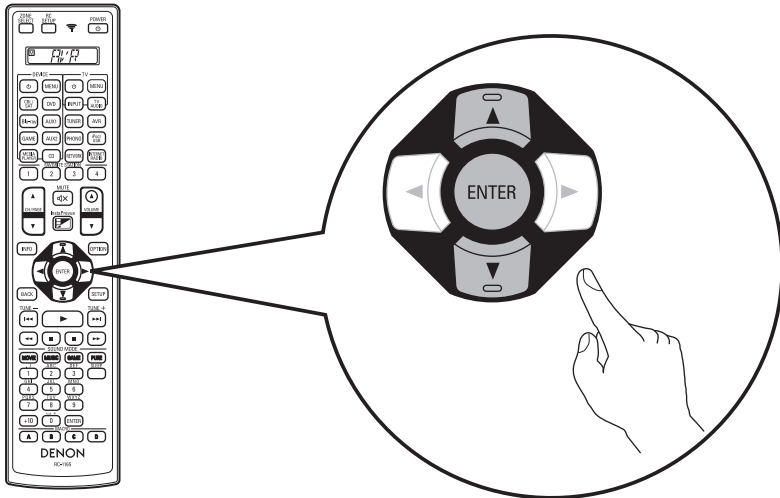

Owner's Manual

The included CD-ROM contains an Adobe PDF version of the full owner's manual for the AV receiver. Please reference this manual for more details about the setup and operation of the receiver and its features.

1 Insert the disc into your PC.

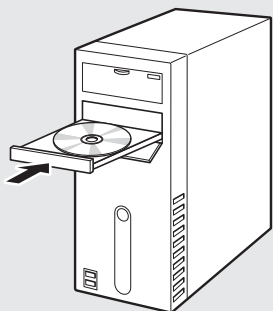

2 Follow the screen or double click on the PDF file.

