

**DENON**

CEOL  
**RCD-N8**  
NETWORK CD RECEIVER

# **Owner's Manual**

## SAFETY PRECAUTIONS

CAUTION

RISK OF ELECTRIC SHOCK  
DO NOT OPEN

**CAUTION:**  
TO REDUCE THE RISK OF ELECTRIC SHOCK, DO NOT REMOVE COVER (OR BACK). NO USER-SERVICEABLE PARTS INSIDE. REFER SERVICING TO QUALIFIED SERVICE PERSONNEL.

The lightning flash with arrowhead symbol, within an equilateral triangle, is intended to alert the user to the presence of uninsulated "dangerous voltage" within the product's enclosure that may be of sufficient magnitude to constitute a risk of electric shock to persons.

The exclamation point within an equilateral triangle is intended to alert the user to the presence of important operating and maintenance (servicing) instructions in the literature accompanying the appliance.

**WARNING:**  
TO REDUCE THE RISK OF FIRE OR ELECTRIC SHOCK, DO NOT EXPOSE THIS APPLIANCE TO RAIN OR MOISTURE.

CAUTION:

HOT SURFACE. DO NOT TOUCH.

The top surface over the internal heat sink may become hot when operating this product continuously. Do not touch hot areas, especially around the "Hot surface mark" and the top panel.

**CAUTION:**

To completely disconnect this product from the mains, disconnect the plug from the wall socket outlet.

The mains plug is used to completely interrupt the power supply to the unit and must be within easy access by the user.

CE 2200
R&TTE Directive 1999/5/EC

This product may be operated in the following countries;

AT	BE	CZ	DK	FI
FR	DE	GR	HU	IE
IT	NL	PL	PT	SK
ES	SE	GB	NO	CH

Indoor use only.

# IMPORTANT SAFETY INSTRUCTIONS

1. Read these instructions.
2. Keep these instructions.
3. Heed all warnings.
4. Follow all instructions.
5. Do not use this apparatus near water.
6. Clean only with dry cloth.
7. Do not block any ventilation openings.  
Install in accordance with the manufacturer's instructions.
8. Do not install near any heat sources such as radiators, heat registers, stoves, or other apparatus (including amplifiers) that produce heat.
9. Protect the power cord from being walked on or pinched particularly at plugs, convenience receptacles, and the point where they exit from the apparatus.
10. Only use attachments/accessories specified by the manufacturer.
11. Use only with the cart, stand, tripod, bracket, or table specified by the manufacturer, or sold with the apparatus. When a cart is used, use caution when moving the cart/apparatus combination to avoid injury from tip-over.
12. Unplug this apparatus during lightning storms or when unused for long periods of time.
13. Refer all servicing to qualified service personnel. Servicing is required when the apparatus has been damaged in any way, such as power-supply cord or plug is damaged, liquid has been spilled or objects have fallen into the apparatus, the apparatus has been exposed to rain or moisture, does not operate normally, or has been dropped.
14. Batteries shall not be exposed to excessive heat such as sunshine, fire or the like.



### DECLARATION OF CONFORMITY

We declare under our sole responsibility that this product, to which this declaration relates, is in conformity with the following standards: EN60065, EN55013, EN55020, EN61000-3-2, EN61000-3-3, EN300328, EN301489-01, EN301489-17 and EN50371.

Following the provisions of Low Voltage Directive 2006/95/EC and EMC Directive 2004/108/EC, the EC regulation 1275/2008 and its frame work Directive 2009/125/EC for Energy-related Products (ErP).

DENON EUROPE  
Division of D&M Germany GmbH  
An der Kleinbahn 18, Nettetal,  
D-41334 Germany

**CAUTION:**  
USE OF CONTROLS OR ADJUSTMENTS OR PERFORMANCE OF PROCEDURES OTHER THAN THOSE SPECIFIED HEREIN MAY RESULT IN HAZARDOUS RADIATION EXPOSURE.  
THIS PRODUCT SHOULD NOT BE ADJUSTED OR REPAIRED BY ANYONE EXCEPT PROPERLY QUALIFIED SERVICE PERSONNEL.

**CLASS 1 LASER PRODUCT**  
**LUOKAN 1 LASERLAITE**  
**KLASS 1 LASERAPPARAT**

“CLASS 1  
LASER PRODUCT”

**ADVARSEL:** USYNLIG LASERSTRÅLING VED ÅBNING, NÅR SIKKERHEDSAFBRYDERE ER UDE AF FUNKTION. UNDGÅ UDSAETTELSE FOR STRÅLING.

**VAROITUS!** LAITTEEN KÄYTTÄMINEN MUULLA KUIN TÄSSÄ KÄYTTÖOHJEESSA MAINITULLA TAVALLA SAATTA ALTISTAA KÄYTTÄJÄN TURVALLISUUSLUOKAN 1 YLITTÄVÄLLE NÄKYMÄTTÖMÄLLE LASERSÄTEILYLLE.

**WARNING:** OM APPARATEN ANVÄNDS PÅ ANNAT SÄTT ÄN I DENNA BRUKSANVISNING SPECIFICERATS, KAN ANVÄNDAREN UTSÄTTAS FÖR OSYNLIG LASERSTRÅLNING SOM ÖVERSKRIDER GRÄNSEN FÖR LASERKLASS 1.

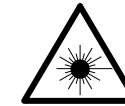

ATTENZIONE: QUESTO APPARECCHIO E' DOTATO DI DISPOSITIVO OTTICO CON RAGGIO LASER. L'USO IMPROPRIO DELL'APPARECCHIO PUO' CAUSARE PERICOLOSE ESPOSIZIONI A RADIAZIONI!!

### A NOTE ABOUT RECYCLING:

This product's packaging materials are recyclable and can be reused. Please dispose of any materials in accordance with the local recycling regulations.

When discarding the unit, comply with local rules or regulations.

Batteries should never be thrown away or incinerated but disposed of in accordance with the local regulations concerning battery disposal.

This product and the supplied accessories, excluding the batteries, constitute the applicable product according to the WEEE directive.



Pb

## ❑ NOTES ON USE

### WARNINGS

- Avoid high temperatures.  
Allow for sufficient heat dispersion when installed in a rack.
- Handle the power cord carefully.  
Hold the plug when unplugging the cord.
- Keep the unit free from moisture, water, and dust.
- Unplug the power cord when not using the unit for long periods of time.
- Do not obstruct the ventilation holes.
- Do not let foreign objects into the unit.
- Do not let insecticides, benzene, and thinner come in contact with the unit.
- Never disassemble or modify the unit in any way.
- Ventilation should not be impeded by covering the ventilation openings with items, such as newspapers, tablecloths or curtains.
- Naked flame sources such as lighted candles should not be placed on the unit.
- Observe and follow local regulations regarding battery disposal.
- Do not expose the unit to dripping or splashing fluids.
- Do not place objects filled with liquids, such as vases, on the unit.
- Do not handle the mains cord with wet hands.
- When the switch is in the OFF (STANDBY) position, the equipment is not completely switched off from MAINS.
- The equipment shall be installed near the power supply so that the power supply is easily accessible.
- Do not keep the battery in a place exposed to direct sunlight or in places with extremely high temperatures, such as near a heater.

### 1. IMPORTANT NOTICE: DO NOT MODIFY THIS PRODUCT

This product, when installed as indicated in the instructions contained in this manual, meets R&TTE directive requirements. Modification of the product could result in hazardous Radio and EMC radiation.

### 2. CAUTION

- Separation distance of at least 20 cm must be maintained between the antenna of this product and all persons.
- This product and its antenna must not be co-located or operating in conjunction with any other antenna or transmitter.

## ❑ CAUTIONS ON INSTALLATION

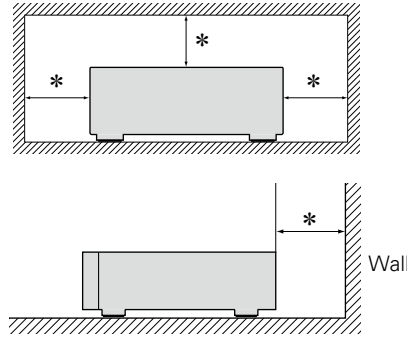

\* **For proper heat dispersal, do not install this unit in a confined space, such as a bookcase or similar enclosure.**

- More than 0.3 m is recommended.
- Do not place any other equipment on this unit.

# Getting started

Thank you for purchasing this DENON product. To ensure proper operation, please read these owner's manual carefully before using the product. After reading them, be sure to keep them for future reference.

## Contents

<b>Getting started</b> .....	<a href="#">1</a>
Accessories .....	<a href="#">2</a>
Main features .....	<a href="#">2</a>
Cautions on handling .....	<a href="#">2</a>
Discs .....	<a href="#">3</a>
Remote operation .....	<a href="#">4</a>

## Preparations .....

[5](#)

<b>Connections</b> .....	<a href="#">6</a>
Connecting the speakers .....	<a href="#">6</a>
Connecting an analog device .....	<a href="#">7</a>
Connecting a digital device .....	<a href="#">7</a>
Connecting a portable player .....	<a href="#">7</a>
Connecting an antenna .....	<a href="#">8</a>
Connecting to a home network (LAN) .....	<a href="#">9</a>
Connecting the power cord .....	<a href="#">10</a>
<b>Setup</b> .....	<a href="#">11</a>
Menu map .....	<a href="#">11</a>
Setting the first setup [Quick Setup] .....	<a href="#">12</a>
Setting the general [General] .....	<a href="#">12</a>
Setting the network [Network] .....	<a href="#">17</a>

## Operations .....

[22](#)

<b>Operations</b> .....	<a href="#">23</a>
Preparations .....	<a href="#">23</a>
Operations possible during playback .....	<a href="#">23</a>
CD playback .....	<a href="#">25</a>
MP3 and WMA files playback .....	<a href="#">28</a>
Network audio playback .....	<a href="#">29</a>
Tuning in radio stations .....	<a href="#">33</a>
Favorite function .....	<a href="#">36</a>
iPod playback .....	<a href="#">37</a>
USB memory device playback .....	<a href="#">40</a>
Portable audio player playback .....	<a href="#">41</a>
Listening to ANALOG IN .....	<a href="#">41</a>
Listening to DIGITAL IN .....	<a href="#">42</a>
AirPlay function .....	<a href="#">43</a>
Remote play function .....	<a href="#">45</a>
Web control function .....	<a href="#">46</a>
Other functions .....	<a href="#">48</a>

## Information .....

[50](#)

<b>Information</b> .....	<a href="#">51</a>
Part names and functions .....	<a href="#">51</a>
iPod .....	<a href="#">56</a>
MP3 and WMA .....	<a href="#">56</a>
USB memory device .....	<a href="#">57</a>
Network audio .....	<a href="#">58</a>
<b>Explanation terms</b> .....	<a href="#">59</a>
<b>Troubleshooting</b> .....	<a href="#">61</a>
<b>Specifications</b> .....	<a href="#">65</a>

## Accessories

Check that the following parts are supplied with the product.

① Quick setup guide .....	1
② CD-ROM (Owner's manual) .....	1
③ Safety Instructions .....	1
④ Service network list.....	1
⑤ Power cord .....	1
⑥ Remote control (RC-1174).....	1
⑦ R03/AAA batteries .....	2
⑧ FM indoor antenna .....	1

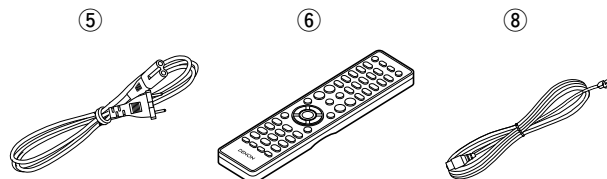

## Main features

### Big sound in Small body

- Full digital sound
- High power output (65 W x 2 channels, 4 Ω)
- High quality sound (LPCM/FLAC 192 kHz/24 bit)

### Compatible with “Denon Remote App” for performing basic operations of the unit.

“Denon Remote App” is application software that allows you to perform basic operations with an iPod touch, iPhone or Android smartphone such as turning the unit ON/OFF, controlling the volume, and switching the sources.

### Supports AirPlay®

This unit also supports AirPlay that lets you stream your music library from an iPhone®, iPad®, iPod touch® or iTunes.

### Wi-Fi compatibility

This unit is equipped with a built-in diversity antenna, and is certified under WMM (Wi-Fi Multimedia) for efficient wireless connectivity. In addition, easy wireless connection is possible by pressing the WPS button.

### iPod®/iPhone® charge function

You can charge your iPhone/iPod by connecting it to the dock connector or USB port. Even if the unit enters the power standby mode, the iPod/iPhone will continue to be charged, and when the iPhone/iPod is fully charged the unit automatically stops supplying power for charging. In addition, if you connect your iPhone/iPod to the dock connector while the unit is in power standby mode, the iPhone/iPod will automatically begin charging.

### 3 Line OLED

Incorporated 3-line display to show file information or menu items legibly. The display can enlarge letters of selected items and show icons clearly. The menu selection supports seven languages.

## Cautions on handling

### • Before turning the power switch on

Check once again that all connections are correct and that there are no problems with the connection cables.

- Power is supplied to some of the circuitry even when the unit is set to the standby mode. When going on vacation or leaving home for long periods of time, be sure to unplug the power cord from the power outlet.

### • Proper ventilation

If the unit is left in a room full of smoke from cigarettes, etc., for long periods of time, the surface of the optical pickup may get dirty, preventing it from receiving signals properly.

### • About condensation

If there is a major difference in temperature between the inside of the unit and its surroundings, condensation may form on parts inside the unit, causing it to fail to operate properly.

If this happens, let the unit sit for an hour or two with the power turned off and wait until there is little difference in temperature before using the unit.

### • Cautions on using mobile phones

Using a mobile phone near this unit may result in noise. If that occurs, move the mobile phone away from the unit when it is in use.

### • Moving the unit

Turn off the power and unplug the power cord from the power outlet. Next, disconnect the cables connected to other system units before moving the unit.

### • About care

- Wipe the cabinet and control panel clean with a soft cloth.
- Follow the instructions when using a chemical cleaner.
- Benzene, paint thinner or other organic solvents as well as insecticide may cause material changes and discoloration if brought into contact with the unit, and should therefore not be used.

# Discs

## Discs playable on this unit

### 1 Music CDs

Discs marked with the logo below can be played in this unit.



### 2 CD-R/CD-RW

#### NOTE

- Discs in special shapes (heart-shaped discs, octagonal discs, etc.) cannot be played. Do not attempt to play them, as doing so can damage the unit.
- Some discs and some recording formats cannot be played.
- Non-finalized discs cannot be played.
- What is finalization?  
Finalization is the process that makes recorded CD-R/CD-RW discs playable on compatible players.



## Holding discs



Do not touch the signal surface.

## Loading discs

- Place the disc in the tray, label side up.
- Make sure the disc tray is fully open when inserting the disc.
- Place the discs flat, 12 cm discs in the outer tray guide (Figure 1), 8 cm discs in the inner tray guide (Figure 2).

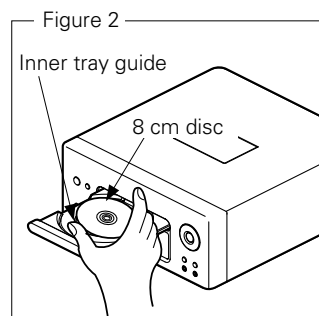
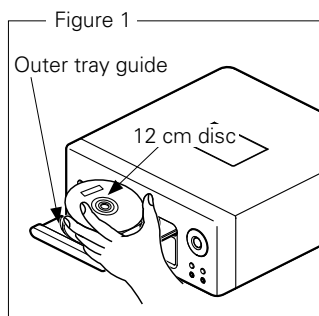

- Place 8 cm discs in the inner tray guide without using an adapter.



- "Unsupported" is displayed if a disc that cannot be played is loaded.
- "No Disc" is displayed if the disc is loaded upside-down or if no disc is loaded.

#### NOTE

Do not push the disc tray in by hand when the power is turned off. Doing so could damage the set.

## Cautions on loading discs

- Only load one disc at a time. Loading two or more discs can damage the unit or scratch the discs.
- Do not use cracked or warped discs or discs that have been repaired with adhesive, etc.
- Do not use discs on which the sticky part of cellophane tape or labels is exposed or on which there are traces of where labels have been removed. Such discs can get caught inside the player and damage it.

## Cautions on handling

- Do not get fingerprints, oil or dirt on discs.
- Take special care not to scratch discs when removing them from their cases.
- Do not bend or heat discs.
- Do not enlarge the hole in the center.
- Do not write on the labeled (printed) surface with ball-point pens, pencils, etc., or stick new labels on discs.
- Water droplets may form on discs if they are moved suddenly from a cold place (outdoors for example) to a warm place, but do not try to dry them off using a hairdryer, etc.

## Cautions on storing discs

- Be sure to remove discs after using them.
- Be sure to store discs in their cases to protect them from dust, scratches, warping, etc.
- Do not store discs in the following places:
  - Places exposed to direct sunlight for long periods of time
  - Dusty or humid places
  - Places exposed to heat from heaters, etc.

## Cleaning discs

- If there are fingerprints or dirt on a disc, wipe them off before using the disc. Fingerprints and dirt can impair sound quality and cause interruptions in playback.
- Use a commercially available disc cleaning set or a soft cloth to clean discs.

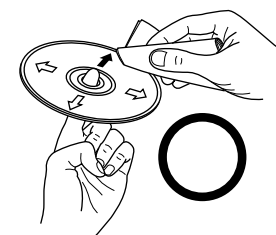

Gently wipe the disc from the inside towards the outside.

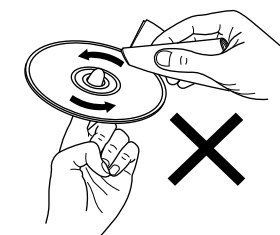

Do not wipe in a circular motion.

#### NOTE

Do not use record spray, antistatic agents, benzene, thinner or other solvents.

# Remote operation

## About the remote control

### ❑ Inserting the batteries

① Remove the remote control's rear cover.

② Set two R03/AAA batteries in the battery compartment in the indicated direction.

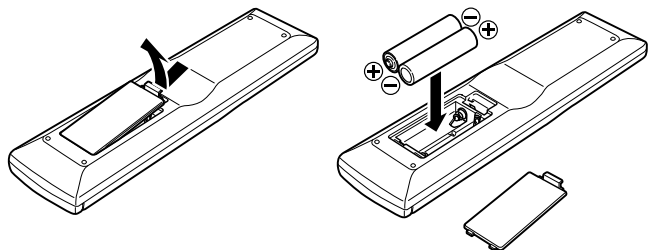

③ Put the rear cover back on.

### NOTE

- Insert the specified batteries in the remote control.
- Replace the batteries with new ones if the set does not operate even when the remote control is operated close to the unit. (The supplied batteries are only for verifying operation. Replace them with new batteries at an early date.)
- When inserting the batteries, be sure to do so in the proper direction, following the ⊕ and ⊖ marks in the battery compartment.
- To prevent damage or leakage of battery fluid:
  - Do not use a new battery together with an old one.
  - Do not use two different types of batteries.
  - Do not attempt to charge dry batteries.
  - Do not short-circuit, disassemble, heat or dispose of batteries in flames.
  - Do not keep the battery in a place exposed to direct sunlight or in places with extremely high temperatures, such as near a heater.
- If the battery fluid should leak, carefully wipe the fluid off the inside of the battery compartment and insert new batteries.
- Remove the batteries from the remote control if it will not be in use for long periods.
- Used batteries should be disposed of in accordance with the local regulations regarding battery disposal.
- The remote control may function improperly if rechargeable batteries are used.

### ❑ Operating range of the remote control

Point the remote control at the remote sensor when operating it.

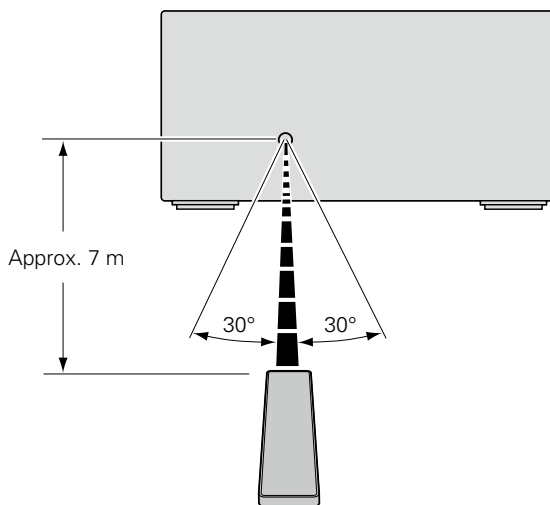

### NOTE

- The set may function improperly or the remote control may not operate if the remote control sensor is exposed to direct sunlight, strong artificial light from an inverter type fluorescent lamp or infrared light.
- When using 3D video devices that transmit radio communication signals (such as infrared signals etc) between the various units (such as the monitor, 3D glasses, 3D transmitter unit etc), the remote control may not operate due to interference from those radio communication signals. If this occurs, adjust the direction and distance of the 3D communication for each unit, and check that the remote control operation is not affected by these signals.

## Denon Remote App

Denon Remote App is a unique application developed for the iPhone, iPod touch and Android smartphone. This application enables you to control DENON network devices that are connected to your home network. Install the App onto your iPhone, iPod touch or Android smartphone to control this device.



- Bidirectional communication is performed.
- The Denon Remote App can be downloaded for free from the Apple App Store or Google Play store.

# Preparations

---

Here, we explain the connections and basic operation methods for this unit.

- **Connections**  [page 6](#)
- **Setup**  [page 11](#)



# Connections

## NOTE

- Do not plug in the power cord until all connections have been completed.
- When making connections, also refer to the operating instructions of the other components.
- Be sure to connect the left and right channels properly (left with left, right with right).
- Do not bundle power cords together with connection cables. Doing so can result in humming or noise.

## Cables used for connections

Audio cable (sold separately)	
Subwoofer cable	
Speaker cable	
Optical cable	
Audio cable	
Stereo mini-plug cable	

## Connecting the speakers

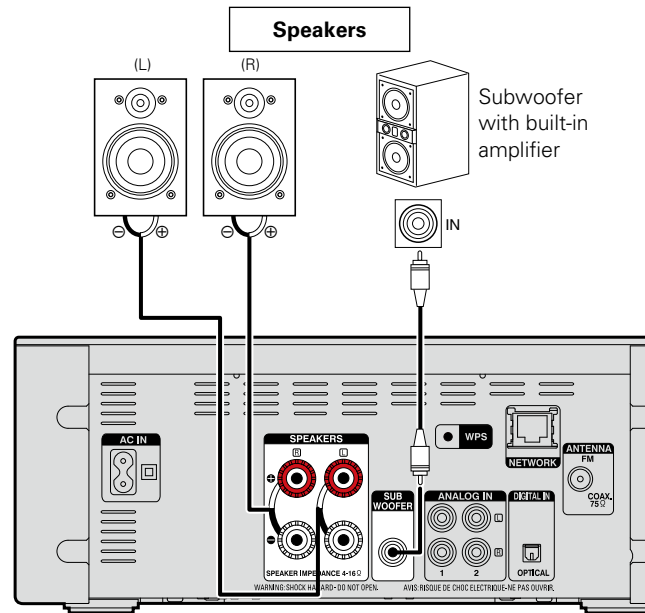

## Connecting the speaker cables

Carefully check the left (L) and right (R) channels and + (red) and – (black) polarities on the speakers being connected to this unit, and be sure to interconnect the channels and polarities correctly.

**1** Peel off about 10 mm of sheathing from the tip of the speaker cable, then either twist the core wire tightly or terminate it.



**2** Turn the speaker terminal counterclockwise to loosen it.



**3** Insert the speaker cable's core wire to the hilt into the speaker terminal.

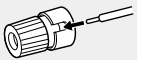

**4** Turn the speaker terminal clockwise to tighten it.

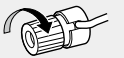

## NOTE

- Disconnect this unit's power plug from the power outlet before connecting the speakers. Also, turn off the subwoofer.
- Use speakers with an impedance of 4 to 16  $\Omega$ . The protection circuit may be activated if speakers with an impedance other than specified are used.
- Connect the speaker cables so they do not stick out of the speaker terminals. The protection circuit may be activated if the wires touch the rear panel or if the + and – sides touch each other (see [page 59](#) "Protection circuit").
- Never touch the speaker terminals while the power supply is connected. Doing so could result in electric shock.

## Connecting an analog device

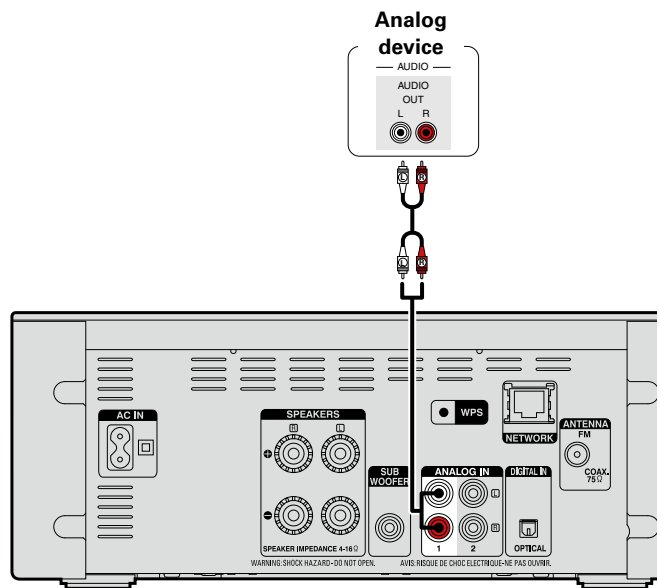

## Connecting a digital device

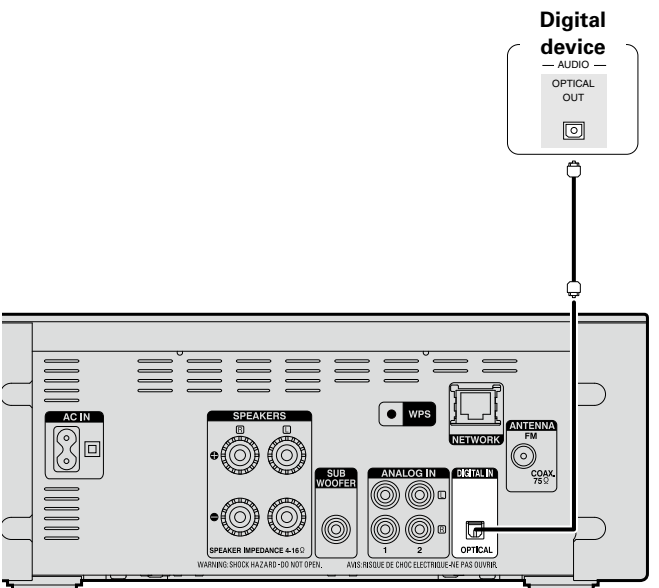

## Connecting a portable player

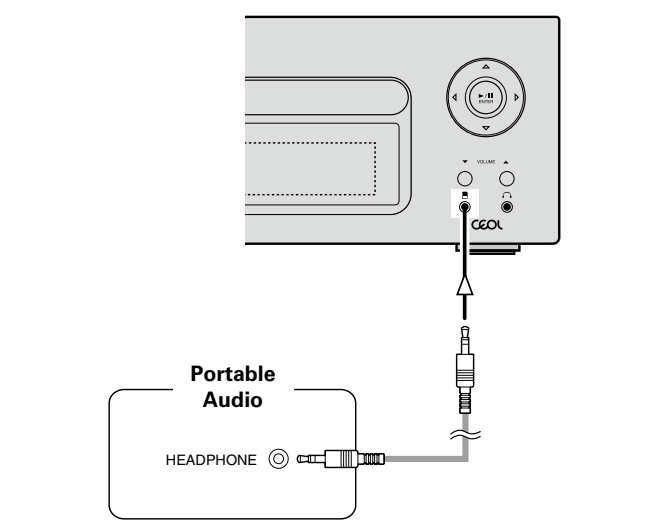

Connect this unit and portable audio player using a separately sold mini-stereo audio cable.

**NOTE**

After you connect a portable audio player, the input source automatically switches to "Portable In".

## Connecting an antenna

- Connect the FM antenna supplied with the unit to enjoy listening to radio broadcasts.
- After connecting the antenna and receiving a broadcast signal ([page 33](#) "Listening to FM broadcasts"), fix the antenna with tape in a position where the noise level becomes minimal.

Direction of broadcasting station

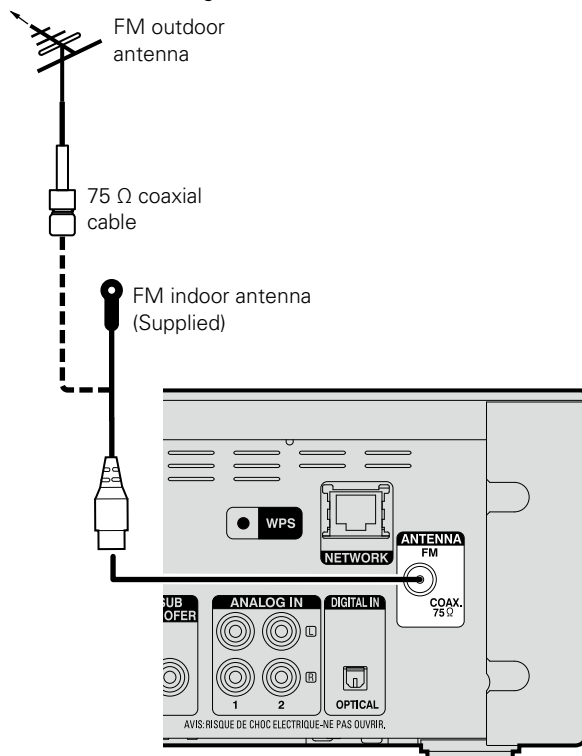

### NOTE

- Do not connect two FM antennas simultaneously.
- If you are unable to receive a good broadcast signal, we recommend installing an outdoor antenna. For details, inquire at the retail store where you purchased the unit.

## Connecting to a home network (LAN)

- This unit lets you play via your home network (LAN) music files stored on a computer and music content such as that from Internet radio.
- You can update by downloading the latest firmware from the DENON website.  
For more information, see “Update” (page 14).
- See “Setting the network [Network]” (page 17) for more information on network setting.

## Wired LAN

### Cables used for connections

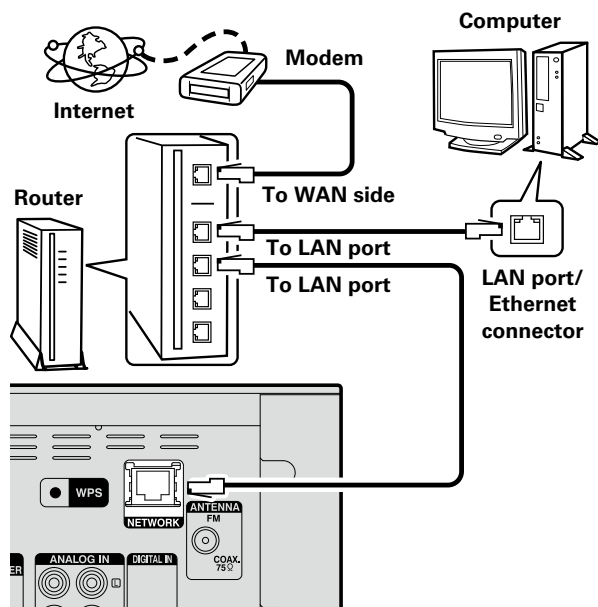
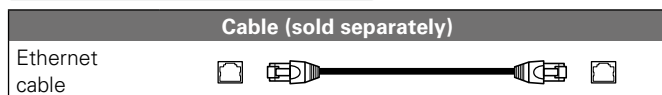

**For connections to the Internet, contact an ISP (Internet Service Provider) or a computer shop.**

## Wireless LAN

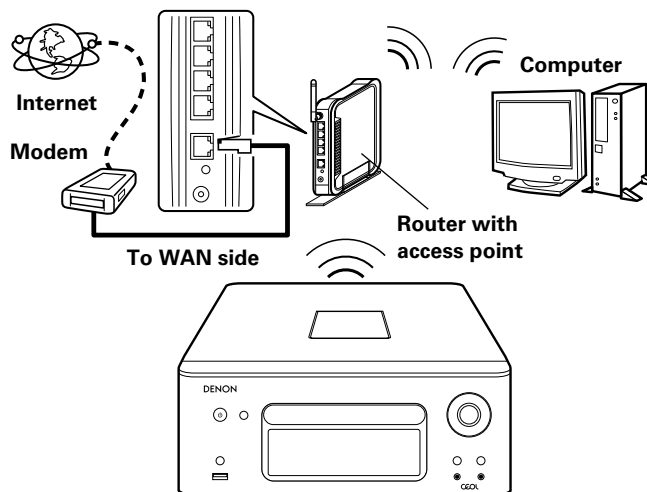

\* This unit comes with a built-in Wi-Fi antenna.

## Required system

### ❑ Broadband internet connection

### ❑ Modem

Device that connects to the broadband circuit and conducts communications on the Internet.

A type that is integrated with a router is also available.

### ❑ Router

When using this unit, we recommend you use a router equipped with the following functions:

- Built-in DHCP server  
This function automatically assigns IP addresses on the LAN.
- Built-in 100BASE-TX switch  
When connecting multiple devices, we recommend a switching hub with a speed of 100 Mbps or greater.
- When using with a wireless LAN, prepare a broadband router with built-in access point.
- When using a WPS (Wi-Fi Protected Setup) compatible router, easy wireless connection is possible by pressing this unit's **WPS** button (page 19).

### ❑ Ethernet cable (CAT-5 or greater recommended)

- Use only a shielded STP or ScTP LAN cable which is available at retailer.
- Some flat type Ethernet cables are easily affected by noise.  
We recommend using a normal type cable.



- If you have an Internet provider contract for a line on which network settings are made manually, make the settings at “Network connecting (when “DHCP” settings is “Off”)” (page 17).
- With this unit, it is possible to use the DHCP and Auto IP functions to make the network settings automatically.
- When using this unit with the broadband router's DHCP function enabled, this unit automatically performs the IP address setting and other settings.  
When using this unit connected to a network with no DHCP function, make the settings for the IP address, etc., at “Network connecting (when “DHCP” settings is “Off”)” (page 17).
- When setting manually, check the setting contents with the network administrator.

### NOTE

- A contract with an ISP is required to connect to the Internet.
- No additional contract is needed if you already have a broadband connection to the Internet.
- The types of routers that can be used depend on the ISP. Contact an ISP or a computer shop for details.
- DENON assumes no responsibility whatsoever for any communication errors or troubles resulting from customer's network environment or connected devices.
- This unit is not compatible with PPPoE. A PPPoE-compatible router is required if you have a contract for a type of line set by PPPoE.
- Do not connect an Ethernet connector directly to the LAN port/Ethernet connector on your computer.
- To listen to audio streaming, use a router that supports audio streaming.

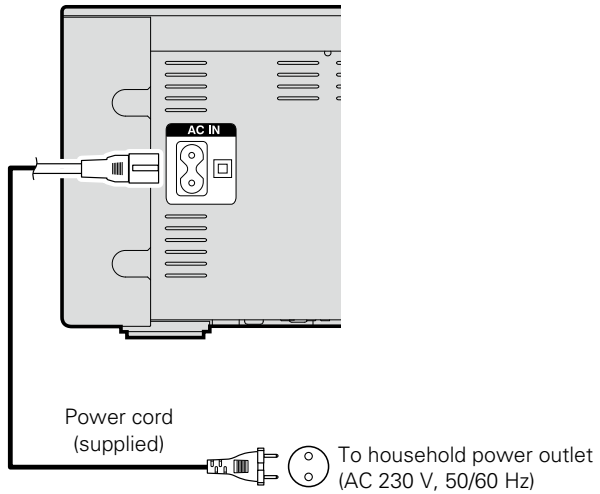

## Connecting the power cord

When all of the connections are completed, insert the power plug into the power outlet.



# Setup

## Menu map

Setting items	Detailed items	Description	Page			
<b>Quick Setup</b> 	<b>Quick Setup</b>	Performs the network settings using a Wizard style window. For details on the operations, see the separate "Quick setup guide".	-			
<b>General</b> 	<b>Alarm</b>	Sets the timer playback.	12			
	<b>Clock</b>	Sets the current time	13			
	<b>Speaker Optimization</b>	Sets the optimum playback properties of the speakers SC-N8, sold separately.	14			
	<b>Language</b>	Sets the language.	14			
	<b>Auto-Standby</b>	Sets the unit power to standby when the unit is not in use.	14			
	<b>Firmware</b>	<b>Update</b>	Updates the firmware.	14		
		<b>Notification</b>	Set the Update and Upgrade notification on/off.	15		
		<b>Add New Feature</b>	Displays new functions that can be downloaded, and upgrades functions.	16		
	<b>Network</b> 	<b>Network Information</b>	Displays various information about the network.	-		
		<b>Network Control</b>	Performs the ON/OFF settings for the network function when in standby mode.	20		
<b>Friendly Name</b>		Edits a name displayed on the Internet.	21			
<b>Last.fm Display</b>		Disables the display of Last.fm on the menu.	21			
<b>Settings</b>		<b>When making wired connection</b>	<b>DHCP (On) or DHCP (Off)</b>	Performs the DHCP setting.	17	
			<b>IP Address*</b>	Performs the IP address setting.	17	
			<b>Subnet Mask*</b>	Performs the subnet mask setting.	17	
			<b>Gateway*</b>	Performs the gateway setting.	17	
			<b>Primary DNS*</b>	Performs the primary DNS setting.	17	
		<b>Wired Setup</b>	<b>Secondary DNS*</b>	Performs the secondary DNS setting.	17	
			<b>Proxy</b>	Performs the proxy setting.	18	
			<b>Test Connection</b>	Performs the wired LAN connection.	17	
			<b>When making Wi-Fi connection</b>	<b>Auto-Scan</b>	Performs the wireless LAN connection setting.	18
				<b>WPS (Wi-Fi Protected Setup)</b>	Selects and sets the wireless connections from the access point list. Sets the wireless connection using WPS (Wi-Fi Protected Setup).	18
<b>Manual</b>		Sets the wireless connection manually.		19		

\* Displayed when the "DHCP" setting is "Off" (refer page 17).

- ❑ To back to the top of the menu, during menu operation

Press TOP MENU.

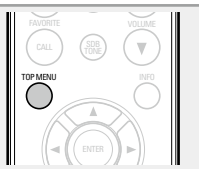

## Setting the first setup [Quick Setup]

- For details on “Quick Setup” operations, see the separate “Quick setup guide”.
- If you cancelled “Quick Setup” menu or changed the network environment, perform “Setup” – “Quick Setup”.

## Setting the general [General]

### Alarm

This device can playback using the alarm playback (everyday alarm, once alarm).

- This unit’s alarm does not support exit time settings for alarm playback.

#### □ Alarm operation when the time settings for alarms overlap

#### When the once alarm and everyday alarm are both set (sleep timer is not set)

- Automatically starts playback at the earlier alarm start time set for either of the alarms.



If the current time is not set, enter alarm setting mode to get time setting mode.

#### □ Setting the everyday alarm and once alarm

- **Everyday alarm (“Everyday”)**  
Playback starts at the set times each day.
- **Once alarm (“Once”)**  
Playback starts once only at the set times.

**1 Press SETUP.**  
Turns on the Menu settings mode and the Menu appears on the display (page 11 “Menu map”).

**2 Use  $\Delta$ / $\nabla$  and ENTER to select “General” – “Alarm”, then press ENTER or  $\triangleright$ .**

**3 Use  $\Delta$ / $\nabla$  to select the alarm mode, and use  $\triangleleft$ / $\triangleright$  to select “On” or “Off” then press ENTER.**

**4 Use  $\Delta$ / $\nabla$  to select “Set Time”, then press ENTER or  $\triangleright$ .**

**5 Use  $\Delta$ / $\nabla$  to select “hours” – “minutes” for the alarm start time, then press ENTER or  $\triangleright$ .**

**6 Use  $\Delta$ / $\nabla$  to select “Source”, then press ENTER or  $\triangleright$ .**

**7 Use  $\Delta$ / $\nabla$  to select the input source, then press ENTER or  $\triangleright$ .**

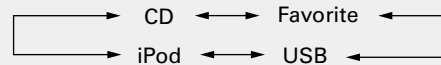

**8 Use  $\Delta$ / $\nabla$  to select “Volume”, then press ENTER or  $\triangleright$ .**

**9 Use  $\Delta$ / $\nabla$  to select the volume “0 – 60”, then press ENTER or  $\triangleright$ .**

**10 Press POWER  $\mathcal{P}$  to set the power to standby.**  
Alarm standby mode is set, and the power indicator lights orange.

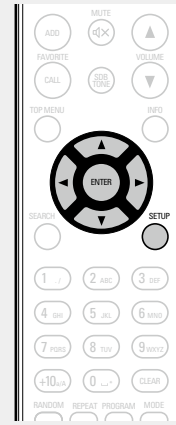

### NOTE

- If the unit or remote control is not operated for 90 minutes or more when the alarm is set to on, the standby mode is activated.
- When using alarm playback on an iPod touch or iPhone, set the iPod touch or iPhone to “Sleep” mode. If the power is switched off using the power off operation, alarm playback cannot be used. For details on the “Sleep” mode of the iPod touch or iPhone, see the instruction manuals of the products or related web pages.

#### □ Setting the alarm to on or off

Perform the operations at “Alarm” (page 12).

- When set to “OFF”, time operation is disabled, but the alarm settings remain unchanged.

#### □ To check the alarm settings

Perform the operations at “Alarm” (page 12).

#### □ To change the alarm settings

Perform the operations at “Alarm” (page 12).

#### □ To change the setting while setting the alarm

Press  $\triangleleft$ .

The setting returns to the previous step. Display the setting you want to change, then make the desired setting.

## Clock

You can automatically adjust the clock of this unit using the Internet.



To use this function, the unit must be connected to the Internet.

### Setting the Time Zone

When changing the time zone, use the following procedure to select your local standard time (time zone).

#### 1 Press **SETUP**.

Turns on the Menu settings mode and the Menu appears on the display. (page 11 "Menu map")

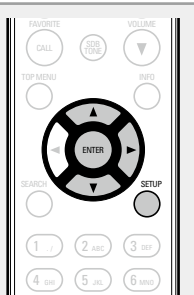

#### 2 Use $\Delta$ / $\nabla$ and **ENTER** to select "General" – "Clock" – "Auto-Adjust" – "Time Zone", then press **ENTER** or $\triangleright$ .

"Time Zone" menu appears.

#### 3 Use $\Delta$ / $\nabla$ to select your time zone, then press **ENTER** or $\triangleright$ .

#### 4 Use $\Delta$ / $\nabla$ and **ENTER** to select "Auto-Adjust" – "Adjust Now", then press **ENTER** or $\triangleright$ .

The setting is entered.

### Setting the Summer Time

Use the following procedure to set Summer time if the Summer time system is used in your country.

#### 1 Press **SETUP**.

Turns on the Menu settings mode and the Menu appears on the display.



#### 2 Use $\Delta$ / $\nabla$ and **ENTER** to select "General" – "Clock" – "Auto-Adjust" – "Summer Time", then press **ENTER** or $\triangleright$ .

"Select Summer Time" menu appears.

#### 3 Use $\Delta$ / $\nabla$ to select "Off (0H)" or "On (+1H)", then press **ENTER** or $\triangleright$ .

#### 4 Use $\Delta$ / $\nabla$ and **ENTER** to select "Auto-Adjust" – "Adjust Now", then press **ENTER** or $\triangleright$ .

The setting is entered.

### Auto Adjust

Use the following procedure to automatically adjust the clock.

#### 1 Press **SETUP**.

Turns on the Menu settings mode and the Menu appears on the display (page 11 "Menu map").

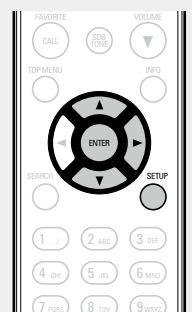

#### 2 Use $\Delta$ / $\nabla$ and **ENTER** to select "General" – "Clock" – "Auto-Adjust" – "Adjust Now", then press **ENTER** or $\triangleright$ .

The operation to receive the current time starts.

- The current time is displayed for several seconds when it is received successfully.
- If the current time is not received successfully, "Connection Failed" appears.

### Setting the current time (Manual Adjust) (24-Hour Display)

#### 1 Press **SETUP**.

Turns on the Menu settings mode and the Menu appears on the display (page 11 "Menu map").

#### 2 Use $\Delta$ / $\nabla$ and **ENTER** to select "General" – "Clock" – "Manual Adjust", then press **ENTER** or $\triangleright$ .

#### 3 Use $\Delta$ / $\nabla$ to set the "hours".

#### 4 Press **ENTER** or $\triangleright$ .

#### 5 Use $\Delta$ / $\nabla$ to set the "minutes".

#### 6 Press **ENTER** or $\triangleright$ .

The current time is set.

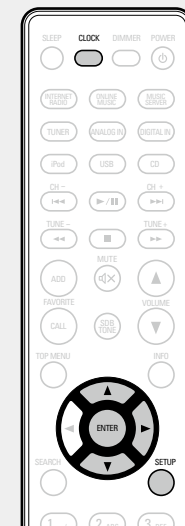

### Checking the current time when the power is on

Press **CLOCK**.

Press once more and the display returns to its original condition.

### Checking the current time when the power is set to standby

Press **CLOCK**.

The current time is displayed for 30 seconds.

#### NOTE

- The time cannot be set when in the standby mode. Turn on the power first.
- The time setting is canceled if the power cord is disconnected. Set the time again.



## Speaker Optimization

An optimizing filter suited for the properties of the speakers (SC-N8) can be used.

### 1 Press **SETUP**.

Turns on the Menu settings mode and the Menu appears on the display ([page 11](#) "Menu map").

### 2 Use $\Delta$ / $\nabla$ and **ENTER** to select "General" – "Speaker Optimization", then press **ENTER** or $\triangleright$ .

"Speaker Optimization" menu appears.

### 3 Use $\Delta$ / $\nabla$ to select "On", then press **ENTER** or $\triangleright$ .

**ON** The response is optimized for the speakers (SC-N8, sold separately).

**OFF** The response is flat.

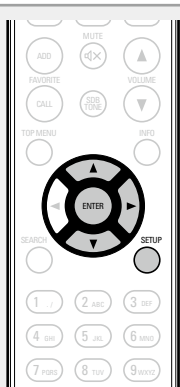

## Auto-Standby

When this unit is in the stop state and there is no input signal and operation for 30 minutes, it automatically enters the standby mode.

For the input source "Analog In 1", "Analog In 2" and "Portable In" only, when no operation is performed for eight hours, this unit automatically enters the standby mode.

- The default setting is "On".

### 1 Press **SETUP**.

Turns on the Menu settings mode and the Menu appears on the display ([page 11](#) "Menu map").

### 2 Use $\Delta$ / $\nabla$ and **ENTER** to select "General" – "Auto-Standby", then press **ENTER** or $\triangleright$ .

"Select Auto-Standby" menu appears.

### 3 Use $\Delta$ / $\nabla$ to select "On", then press **ENTER** or $\triangleright$ .

The setting is entered.

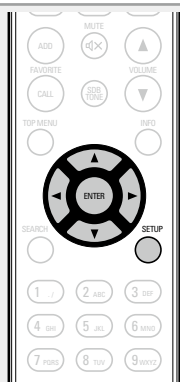

### NOTE

In the following situations, the Auto-standby function does not operate.

- When the source is "Tuner", "iPod" (Remote mode) or "AirPlay".
- During CD playback or pause.

## Firmware

### Update

- In order to update the firmware, the environment and settings required for connecting to broadband internet are needed ([page 9](#)).
- Perform the firmware update operation after at least 2 minutes has elapsed since turning this unit's power ON.

### 1 Press **SETUP**.

Turns on the Menu settings mode and the Menu appears on the display ([page 11](#) "Menu map").

### 2 Use $\Delta$ / $\nabla$ and **ENTER** to select "General" – "Firmware" – "Update", then press **ENTER** or $\triangleright$ .

**Check For Update** Check for firmware updates. You can also check approximately how long it will take to complete an update.

**Update Start** Execute the update process.

- If updating fails, the set automatically retries, but if updating is still not possible, one of the messages shown below is displayed. If the display reads as shown below, check the settings and network environment, then update again.

Display	Description
<b>Updating fail</b>	Updating failed.
<b>Login failed</b>	Failure to login to server.
<b>Server is busy</b>	Server is busy. Wait a while then try again.
<b>Connection fail</b>	Failure in connecting to server.
<b>Download fail</b>	Downloading of the firmware has failed.

## Language

Sets the language for display the menu.

- The factory language setting is "English".

### 1 Press **SETUP**.

Turns on the Menu settings mode and the Menu appears on the display ([page 11](#) "Menu map").

### 2 Use $\Delta$ / $\nabla$ and **ENTER** to select "General" – "Language", then press **ENTER** or $\triangleright$ .

English / Deutsch / Français /  
Italiano / Nederlands / Español /  
Svenska

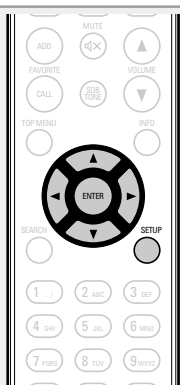

## Update on web screen

Firmware can be updated using the “Web control function” (page 46).

“Web control function” (page 46) settings must be completed in advance on a PC belonging to the same network.

For information on obtaining update files, please contact our customer service center.

### 1 Click ④ from step 5 for the “Web control function” (page 46).

The PC will display the following screen.

Wait for approximately 1 minute.

You can also gain access by entering the IP address shown by the unit into a web browser.

#### [The web display]

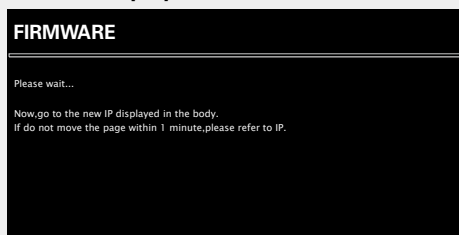

#### [The unit's screen display]

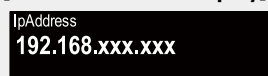

### 2 When the following screen is displayed by the PC, click the “Choose File” (①) button, select the update file, and click the “Upload” (②) button.

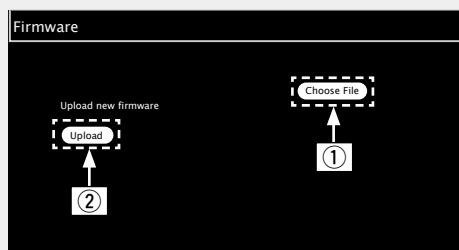

### 3 When the following screen is displayed, click the “OK” (③) button.

Updating will begin.

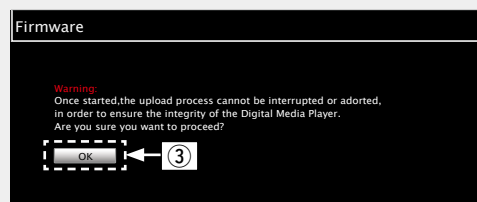

#### NOTE

Do not operate the unit while updating is in progress.

### 4 When the following screen is displayed, updating is complete.

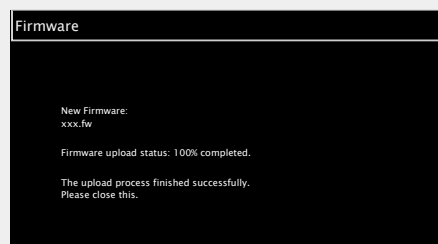

Button names may vary depending on the OS language used on your computer.

## Notification

### Update

Displays a notification message on this unit's menu screen when the latest firmware is released with “Update”.

Connect to broadband Internet (page 9) when using this function.

### 1 Press SETUP.

Turns on the Menu settings mode and the Menu appears on the display (page 11 “Menu map”).

### 2 Use $\Delta$ / $\nabla$ and ENTER to select “General” – “Firmware” – “Notification” – “Update”, then press ENTER or $\triangleright$ .

“Update Notification” menu appears.



### 3 Use $\Delta$ / $\nabla$ to select “On”, then press ENTER or $\triangleright$ .

**On** Display update message.

**Off** Do not display update message.



- When you press **ENTER** during display of the notification message, the “Check for Update” is displayed. (Refer to page 14 for more information on “Update”.)
- Press  $\triangleleft$  to erase the notification message.

## Upgrade

Display a notification message on this unit's menu screen when downloadable firmware is released with "Add New Feature". Connect to broadband Internet ([page 9](#)) when using this function.

### 1 Press **SETUP**.

Turns on the Menu settings mode and the Menu appears on the display ([page 11](#) "Menu map").

### 2 Use $\Delta$ / $\nabla$ and **ENTER** to select "General" – "Firmware" – "Notification" – "Upgrade", then press **ENTER** or $\triangleright$ .

"Upgrade Notification" menu appears.

### 3 Use $\Delta$ / $\nabla$ to select "On", then press **ENTER** or $\triangleright$ .

**On** Display upgrade message.

**Off** Do not display upgrade message.

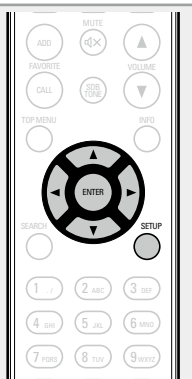

- When you press **ENTER** during display of the notification message, the "Add New Feature" is displayed. (Refer to [page 16](#) for more information on "Add New Feature".)
- Press  $\triangleleft$  to erase the notification message.

## □ Add New Feature

- In order to add new functions, the environment and settings required for connecting to broadband internet are needed ([page 9](#)).
- Perform the add new feature operation after at least 2 minutes has elapsed since turning this unit's power on.

### 1 Press **SETUP**.

Turns on the Menu settings mode and the Menu appears on the display ([page 11](#) "Menu map").

### 2 Use $\Delta$ / $\nabla$ to select "General" – "Firmware" – "Add New Feature", then press **ENTER** or $\triangleright$ .

**Upgrade Status** Display a list of the additional functions provided by the upgrade.

**Upgrade Start** Execute the upgrade process.

- If the upgrade is not successful, an error message identical to those in "Update" ([page 14](#)) will appear on the display. Check the settings and network environment, then update again.

**Upgrade ID** The ID number shown on this screen is needed when carrying out the procedure.



See the DENON website for details about updates. When the procedure is complete, "Registered" is displayed and updates can be carried out. If the procedure has not been carried out, "Not Registered" is displayed.

## [Notes concerning use of "Update" and "Add New Feature"]

- Do not turn off the power until updating or upgrading is completed.
- Even with a broadband connection to the Internet, approximately 20 minutes is required for the updating/upgrading procedure to be completed.
- Once updating/upgrade starts, normal operations on this unit cannot be performed until updating/upgrading is completed.
- Furthermore, updating/upgrading the firmware may reset the backup data for the parameters, etc. set for this unit.
- If the update or upgrade fails, remove and re-insert the power cord. "Update Retry" appears on the display and update restarts from the point at which update failed. If the error continues despite this, check the network environment.



- Information regarding the "Update" function and "Add New Feature" will be announced on the DENON web site each time related plans are defined.
- When usable new firmware is released with "Update" or "Add New Feature", a notification message is displayed on the menu screen. When you do not want to be notified, set "Update" ([page 15](#)) and "Upgrade" ([page 16](#)) to "Off".

## Setting the network [Network]

- For details on “Quick Setup” operations, see the separate “Quick setup guide”.
- If you cancelled “Quick Setup” menu or changed the network environment, perform “Setup” – “Network” – “Quick Setup”.

### Connecting wired LAN

Use this procedure to configure the wired LAN settings.

#### Network connecting

##### (when “DHCP” settings are “On”)

When using this unit with the broadband router’s DHCP function enabled, this unit automatically performs the IP address setting and other settings.

**1** Connect the ETHERNET cable ( [page 9](#) “Connecting to a home network (LAN)” – “Wired LAN”).

**2** Press **POWER**  to turn on power to the main unit.

**3** Press **SETUP**.  
Turns on the Menu settings mode and the Menu appears on the display ( [page 11](#) “Menu map”).

**4** Use  $\Delta$   $\nabla$  and **ENTER** to select “Network” – “Settings” – “DHCP (On)”, then press **ENTER** or  $\triangleright$ .  
“Select DHCP” menu appears.

**5** Use  $\Delta$   $\nabla$  to select “On”, then press **ENTER** or  $\triangleright$ .  
“DHCP (On)” menu appears.



**6** Use  $\Delta$   $\nabla$  to select “Test Connection”, then press **ENTER** or  $\triangleright$ .

“Wait for the network to connect...” is displayed, and the unit starts connecting to the LAN.

- When the connection is made successfully, “Connected!” appears.
- If the connection cannot be established, “Connection Failed” is displayed. Perform steps 1 – 6 again.



You may need to set the network connection manually, depending on the provider you use. To set the connection manually, use the setting procedure of “Network connecting (when “DHCP” settings are “Off”)”.

#### Network connecting (when “DHCP” settings is “Off”)

This section explains the settings when connecting this unit to a network that does not have a DHCP function.



To configure the settings manually, check the setting details with your network administrator.

**1** Perform steps 1 – 4 of the “Network connecting (when “DHCP” settings are “On”)” procedure and select “Off” in step 5.  
“DHCP (Off)” menu appears.

**2** Use  $\Delta$   $\nabla$  to select “IP Address”, then press **ENTER** or  $\triangleright$ .  
“Enter IP Address” menu appears.

**3** Use  $\Delta$   $\nabla$   $\triangleright$  or 0 – 9 to input the IP address and press **ENTER**.

**4** Use  $\Delta$   $\nabla$   $\triangleright$  or 0 – 9 to input the address for “Subnet Mask”, “Gateway”, “Primary DNS”, and “Secondary DNS”.

**5** Use  $\Delta$   $\nabla$  to select “Test Connection”, then press **ENTER** or  $\triangleright$ .

“Wait for the network to connect...” is displayed, and the unit starts connecting to the LAN.

- When the connection is made successfully, “Connected!” appears.
- If the connection cannot be established, “Connection Failed” is displayed. Perform steps 1 – 4 again.



## Proxy settings

Configure these settings to connect to the internet via a proxy server.

### 1 Press **SETUP**.

Turns on the Menu settings mode and the Menu appears on the display ([page 11](#) "Menu map").

### 2 Use $\Delta$ / $\nabla$ and **ENTER** to select "Network" – "Settings" – "Proxy", then press **ENTER** or $\triangleright$ .

"Setup Proxy" menu appears.

### 3 If "Proxy(On)" appears, go to step 5.

If "Proxy(Off)" appears, press **ENTER** or  $\triangleright$ .

"Select Proxy" menu appears.

### 4 Use $\Delta$ / $\nabla$ to select "On", then press **ENTER** or $\triangleright$ .

"Setup Proxy" menu appears.

### 5 Use $\Delta$ / $\nabla$ to select "Proxy (Address)" or "Proxy (Name)", then press **ENTER** or $\triangleright$ .

"Select Type" menu appears.

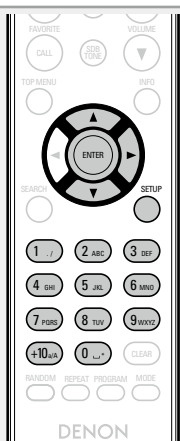

### 6 Use $\Delta$ / $\nabla$ to select "Address" or "Name", then press **ENTER** or $\triangleright$ .

"Setup Proxy" menu appears.

### 7 Use $\Delta$ / $\nabla$ to select "Address" or "Name", then press **ENTER** or $\triangleright$ .

"Enter Proxy Address" or "Enter Proxy Name" menu appears.

### 8 Use $\Delta$ / $\nabla$ / $\triangleright$ or **0 – 9, +10** to input the address or name, then press **ENTER**.

"Setup Proxy" menu appears.

### 9 Use $\Delta$ / $\nabla$ to select "Port", then press **ENTER** or $\triangleright$ .

"Enter Proxy Port" menu appears.

### 10 Use $\Delta$ / $\nabla$ / $\triangleright$ or **0 – 9** to input the port, then press **ENTER**.

The Proxy settings are completed.

## Connecting wireless LAN

Use this procedure to configure the wireless LAN settings.

### Auto-Scan (Wireless LAN)

If a LAN cable is connected, remove it.

### 1 Press **POWER** $\mathbb{P}$ to turn on power to the main unit.

### 2 Press **SETUP**.

Turns on the menu settings mode and the menu appears on the display ([page 11](#) "Menu map").

### 3 Use $\Delta$ / $\nabla$ and **ENTER** to select "Network" – "Settings" – "Auto-Scan", then press **ENTER** or $\triangleright$ .

The access point you have set is displayed.

### 4 Use $\Delta$ / $\nabla$ to select the access point, and then press **ENTER** or $\triangleright$ .

- If the access point is not detected automatically, configure it manually ([page 20](#) "Manual Settings").



## 5 If there is an encryption setting for the access point you selected in step 4, enter same encryption key as used for the access point. (If there is no encryption setting, proceed to step 6.)

Use  $\Delta$   $\nabla$   $\triangleleft$   $\triangleright$  or **0–9, +10** to input the “Password” (encryption key) and press **ENTER** or  $\triangleright$ . Enter the same encryption key as used for the access point.

- The types of characters that can be input are as shown below.

### [Lower case characters]

abcdefghijklmnopqrstuvwxyz

### [Upper case characters]

ABCDEFGHIJKLMNOPQRSTUVWXYZ

[Symbols] ! " # \$ % & ' ( ) \* + , - . / : ; < = > ? @ [ \ ] ^ \_ ` { | } ~

[Numbers] 0123456789 (Space)

- When no security settings have been used in the Internet connection settings, this step is not necessary.

## 6 Use $\nabla$ to select “Test Connection”, then press **ENTER** or $\triangleright$ .

“Wait for the network to connect...” is displayed, and the unit starts connecting to the network.

- This unit performs automatic network setup due to the DHCP function.

## ❑ WPS Settings (Push-button method)

By just pressing the WPS button on your router and this unit, the wireless LAN connection settings are made.



- Before turning this unit on, make sure that an Ethernet cable is not connected to this unit. If a cable is connected, have this unit enter the power standby mode and disconnect the cable.
- After the unit is turned on, it takes approximately 30 seconds for the WPS button on this unit to be available.

### 1 Press the WPS button of the router.

### 2 Press WPS on the rear panel.

“Wait for the network to connect...” is displayed, and the unit starts connecting to the LAN.



- When the connection is made successfully, “Connected!” appears.
- If the connection cannot be established, “Connection Failed” is displayed. Perform steps 1 – 2 again.

### NOTE

If the router uses WEP, WPA-TKIP or WPA2-TKIP encryption, connection is not possible using the **WPS** button. In this case, connect using “Auto-scan” or “Manual”.

## ❑ WPS Settings (PIN code method)

### 1 Press **SETUP**.

Turns on the Menu settings mode and the Menu appears on the display ([page 11](#) “Menu map”).

### 2 Use $\Delta$ $\nabla$ and **ENTER** to select “Network” – “Settings” – “WPS (Wi-Fi Protected Setup)” – “PIN code”, then press **ENTER** or $\triangleright$ .

The access point that you have set is displayed.

### 3 Use $\Delta$ $\nabla$ to select the access point whose PIN code you want to display, and press **ENTER** or $\triangleright$ .

PIN code number is displayed.

### 4 Set this PIN code to the register.

When connection is established with access point, “Connected!” is displayed.

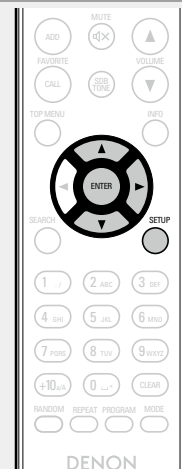

## Manual Settings

### 1 Press **SETUP**.

Turns on the Menu settings mode and the Menu appears on the display (☞ page 11 "Menu map").

### 2 Use $\Delta$ / $\nabla$ and **ENTER** to select "Network" – "Settings" – "Manual", then press **ENTER** or $\triangleright$ .

### 3 Use $\Delta$ / $\nabla$ to select "SSID", then press **ENTER** or $\triangleright$ .

### 4 Use $\Delta$ / $\nabla$ / $\triangleleft$ / $\triangleright$ or **0–9, +10** to input the name of the wireless network (SSID), then press **ENTER**.

• The types of characters that can be input are as shown below.

#### [Lower case characters]

abcdefghijklmnopqrstuvwxyz

#### [Upper case characters]

ABCDEFGHIJKLMNOPQRSTUVWXYZ

[Symbols] ! " # \$ % & ' ( ) \* + , - . / : ; < = > ? @ [ \ ] ^ \_ ` { | } ~

[Numbers] 0 1 2 3 4 5 6 7 8 9 (Space)

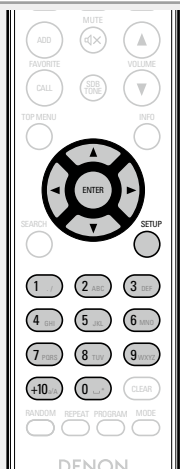

### 5 Use $\Delta$ / $\nabla$ to select "Security", then press **ENTER** or $\triangleright$ .

### 6 Use $\Delta$ / $\nabla$ to select following items, then press **ENTER** or $\triangleright$ .

- **None** Select if not encrypted. Can also be used even without encryption, through we recommend encryption for improved security.
- **WEP** / **WPA(TKIP)** / **WPA(AES)** / **WPA2(TKIP)** / **WPA2(AES)** Select the encryption method according to the encryption setting of the access point you are using.

### 7 Use $\Delta$ / $\nabla$ to select "Password", then press **ENTER**.

### 8 Use $\Delta$ / $\nabla$ / $\triangleleft$ / $\triangleright$ to enter the encryption key, and press **ENTER**.

Enter the same encryption key as used for the access point.

- When no security settings have been used in the Internet connection settings, this step is not necessary.
- When connecting to a "WEP" encrypted network, set the access point "Default Key" to "Key 1".

### 9 Use $\nabla$ to select "Test Connection" and press **ENTER** or $\triangleright$ .

"Wait for the network to connect..." is displayed, and the unit starts connecting to the network.

- This unit performs automatic network setup due to the DHCP function.

#### NOTE

This unit is not compatible with WEP (TSN) encryption system.

## Other network settings

### Network Control

Set the network function On/Off during standby.

### 1 Press **SETUP**.

Turns on the Menu settings mode and the Menu appears on the display (☞ page 11 "Menu map").

### 2 Use $\Delta$ / $\nabla$ to select "Network" – "Network Control", then press **ENTER** or $\triangleright$ .

"Network Control" menu appears.

### 3 Use $\Delta$ / $\nabla$ to select "On", then press **ENTER** or $\triangleright$ .

**On** Network is on during standby. Main unit operable with a network compatible controller. Shortens the time before the network connection is completed.

- When "Network Control" is set to "On", the power display lights red.
- More power is consumed when in standby (Power consumption: 3 W).

**Off** Suspend network function during standby. It will take slightly longer till the network connection is completed.

- The minimum amount of power is consumed when in standby (Power consumption: 0.3 W).
- This is the default setting.

### 4 Press **SETUP**.

The display returns to normal.

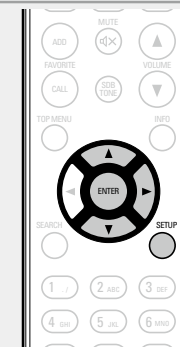

## □ Friendly Name

The Friendly Name is the name of this unit displayed on the network (Maximum 63 characters).

### 1 Press **SETUP**.

Turns on the Menu settings mode and the Menu appears on the display ([page 11](#) "Menu map").

### 2 Use $\Delta$ / $\nabla$ to select "Network" – "Friendly Name", then press **ENTER** or $\triangleright$ .

"Friendly Name" menu appears.

### 3-1 [When $\triangleright$ is pressed]

Choose from preset names.

Use  $\Delta$ / $\nabla$  to select a name, then press **ENTER**.

Preset names

Current friendly name / DENON RCD-N8 / AV Room / Bedroom / Dining Room / Family Room / Guest Room / Kids Room / Kitchen / Living Room / Office / CEOL (default) / Other

### 3-2 [When **ENTER** is pressed]

Edit a friendly name.

- For character input, see [page 48](#).



## □ Last.fm Display

Set whether or not to display Last.fm item on the menu.

### 1 Press **SETUP**.

Turns on the Menu settings mode and the Menu appears on the display ([page 11](#) "Menu map").

### 2 Use $\Delta$ / $\nabla$ to select "Network" – "Last.fm Display", then press **ENTER** or $\triangleright$ .

"Last.fm Display" appears.

### 3 Use $\Delta$ / $\nabla$ to select "Show" or "Hidden", then press **ENTER** or $\triangleright$ .

**Show** Last.fm items will be displayed.

**Hide** Last.fm items will not be displayed.

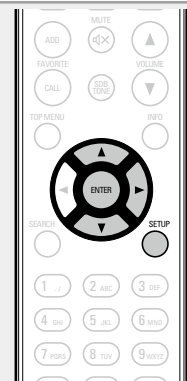

















## □ Resetting the friendly name to the default setting

In step 3-1, select "CEOL (Default)" and press **ENTER**.



# Operations

Here, we explain functions and operations that let you make better use of this unit.

- Preparations  [page 23](#)
- Operations possible during playback  [page 23](#)
- CD playback  [page 25](#)
- MP3 and WMA files playback  [page 28](#)
- Network audio playback  [page 29](#)
- Tuning in radio stations  [page 33](#)
- Favorite function  [page 36](#)
- iPod playback  [page 37](#)
- USB memory device playback  [page 40](#)
- Portable audio player playback  [page 41](#)
- Listening to ANALOG IN  [page 41](#)
- Listening to DIGITAL IN  [page 42](#)
- AirPlay function  [page 43](#)
- Remote play function  [page 45](#)
- Web control function  [page 46](#)
- Other functions  [page 48](#)

# Operations

This section provides information on operations of playback procedures.

## Preparations

### Turning the power on

Press **POWER** .

The power indicator lights white and the power turns on.



- When you turn on the power of this unit for the first time after purchasing it, the “Quick Setup” menu starts up. For details on “Quick Setup” operations, see the separate “Quick setup guide”.
- If you cancelled “Quick Setup” menu or changed the network environment, perform “Setup” – “Quick Setup”.

### Turning the power to standby mode

Press **POWER** .

The unit enters standby mode.

- Power indicator
  - Standby : Off
  - Network Control – “On” : Red
  - iPod charge standby : Red
  - Alarm standby : Orange



#### NOTE

Power continues to be supplied to some of the circuitry even when the power is in the standby mode. When leaving home for long periods of time, unplug the power cord from the power outlet.

### Completely turning off the power

Unplug the power cord from the wall outlet.

## Operations possible during playback

### Selecting the input source

#### Selecting the input source using the main unit

- 1 Press SOURCE.**  
The display changes to the input source selection screen.
- 2 Press  $\Delta$ / $\nabla$  to select the input source.**  
The input source is switched each time the button is pressed.

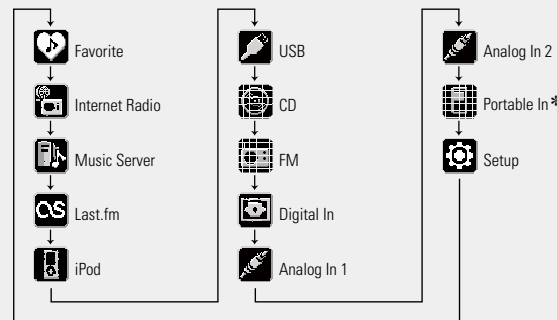

\* “Portable In” appears only when the portable audio player is connected to portable in jack.



With the unit, you can play back music files stored on your iPhone/iPod touch and music from iTunes ([page 43](#) “AirPlay function”).

#### Selecting the input source using the remote control

Press the input source select button (**INTERNET RADIO, ONLINE MUSIC, MUSIC SERVER, TUNER, ANALOG IN, DIGITAL IN, iPod, USB, CD**).

- The desired input source can be selected directly.
- The input source is switched as follows each time **ANALOG IN** is pressed.

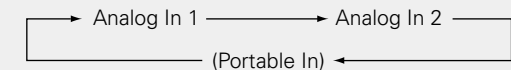

- When there is no portable audio player connected to the portable in jack, “Portable In” is not displayed when you press **ANALOG IN**.

### Adjusting the master volume

Use **VOLUME  $\Delta$ / $\nabla$**  to adjust the volume.

The volume level is displayed.

**[Variable range]**

0 – 60



You can also do this by turning **VOLUME** on the main unit.

## Adjusting the tone

**1** Press **SDB TONE** to select the tone parameter to be adjusted.

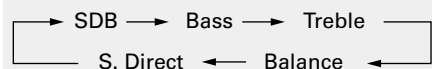

**2** Use **◀ ▶** to adjust the “SDB”, “Bass”, “Treble” or “Balance”.

- To make other tone adjustments at this time, press **SDB TONE**.
- If no operation is performed for 5 seconds, the adjustment is retained and the normal display reappears.

**SDB** Emphasize the +10 dB bass sound.

**[Selectable modes]** **On** – **Off**

**Bass** Adjusts the bass sound.

**[Variable range]** **-10dB** – **+10dB**

**Treble** Adjusts the treble sound.

**[Variable range]** **-10dB** – **+10dB**

**Balance** Adjusts the left/right volume balance.

**[Variable range]** **L6** – **Center** – **R6**

Press **◀** when you want to adjust the left channel, **▶** when you want to adjust the right channel.

**S.Direct** The tone is not adjusted.

### [Default settings]

- SDB : Off
- Bass : 0dB
- Treble : 0dB
- Balance : Center

## Turning off the sound temporarily

Press **MUTE** . The “MUTING” is displayed.



To cancel, press **MUTE** again. The mute mode is also canceled when **VOLUME** is pressed.

## Setting the sleep timer

Use this function to automatically switch the power to the standby mode after a specific amount of time (minutes).

The sleep timer can be set to up to 90 minutes, in steps of 10 minutes.

Press **SLEEP** during playback and select the setting time.

- Press the button to select the setting time.
- After about 3 seconds, the setting is entered and the display returns to as it was before.



### Canceling the sleep timer

Either press **SLEEP** to select “Sleep▶OFF” or press **POWER** .

### To check the time remaining until the sleep timer is activated

Press **SLEEP**.

## Switching the display's brightness

Press **DIMMER**.

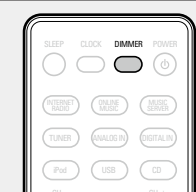

- The display brightness is adjusted each time **DIMMER** is pressed as shown below.

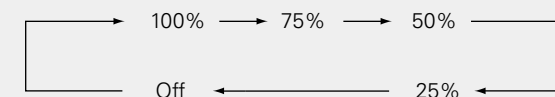

If you operate the buttons when the display's brightness is set to “Off”, the display temporarily lights at “25%” brightness level.

## Listening with headphones

Plug the headphones (sold separately) into .

- The sound from the speakers is automatically cut off.

### NOTE

To prevent hearing loss, do not raise the volume level excessively when using headphones.



## CD playback

This section explains how to playback CDs.

### Before playing a disc

**1** Press **POWER** .

**2** Press **SOURCE** and  $\Delta$ / $\nabla$  to select to “”, then press **ENTER**, **▶/||** **ENTER** or **▷**, or press **CD**.

If no disc is loaded “No Disc” is displayed.

**3** Insert a disc ([page 3](#)).

- Press to open/close the disc tray.
- The disc tray also closes when **▶/||** **ENTER** or **▶/||** is pressed.

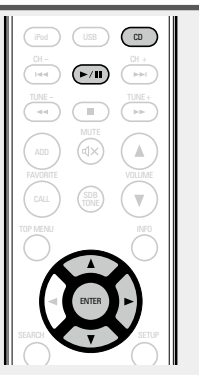

#### NOTE

- Do not place any foreign objects in the disc tray. Doing so could damage it.
- Do not push the disc tray in by hand when the power is turned off. Doing so could damage the set.

### Playing CDs

Press **▶/||** **ENTER** or **▶/||**.

The “” indicator lights and playback begins.



- If the input source is set to something other than “”, press **CD** to switch the input source to “”.
- The input source can also be switched to “” using **SOURCE** ([page 23](#)).

#### Stopping playback

Press .

#### Stopping playback temporarily

Press **▶/||** **ENTER** or **▶/||**.

is displayed.

- To resume playback, press **▶/||** **ENTER** or **▶/||**.

#### Fast-forwarding and fast-reversing (searching)

During playback, press and hold in or .

#### Moving to the beginning of tracks (skipping)

During playback, press or .

- The disc skips as many tracks as times the button is pressed.
- When you press reverse once, playback returns to the beginning of the current track.

#### To play the desired track (remote control only)

Press **0 – 9**, **+10** to select the track.

**[Example]** Track 4 : **4**

**[Example]** Track 12 : **+10, 2**

**[Example]** Track 20 : **+10, +10, 0**

## Switching the display

Press **INFO**.

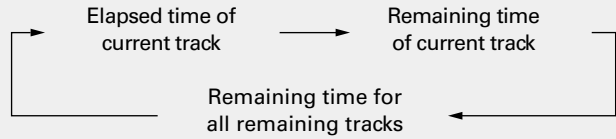
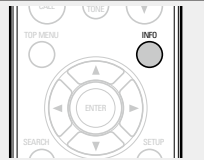

• The display switches each time the button is pressed.



## Playing repeatedly (Repeat playback)

Press **REPEAT**.

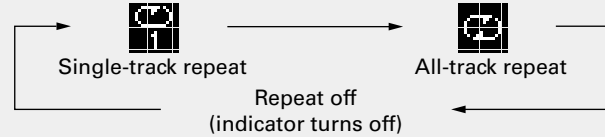
Playback in the respective repeat mode starts.



### [Selectable items]

-  1 (Single-track repeat) Only 1 track plays repeatedly.
-  ALL (All-track repeat) All tracks play repeatedly.
- Repeat off (indicator turns off) Normal playback resumes.

## Playing random order (Random playback)

**1** In the stop mode, press **RANDOM**.  
The "∞" is displayed.

**2** Press **▶/|| ENTER** or **▶/||**.  
The tracks start playing in random order.

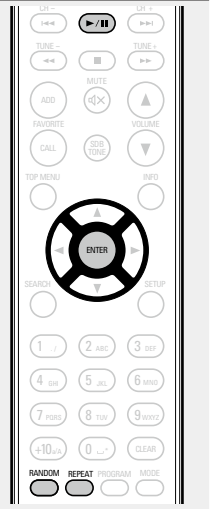

If **REPEAT** is pressed during random playback, after the current session of random playback is finished, another session in a different order of tracks starts.

### NOTE

Random play cannot be set or canceled during playback.

### ❑ Canceling random playback

While stopped, press **RANDOM**.

The "∞" turns off.

## Playing tracks in the desired order (Program playback)

Up to 25 tracks can be programmed.

**1** In the stop mode, press **PROGRAM**.  
"Program" is displayed.

**2** Use **0 – 9, +10** to select the tracks.

**[Example]** To program tracks 3, 12, 7 to play in that order:  
Press **PROGRAM, 3, +10, 2, 7**.

**3** Press **▶/|| ENTER** or **▶/||**.  
Playback starts in the programmed order.

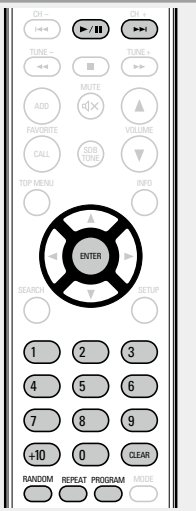

### ❑ Checking the order of the programmed tracks

In the stop mode, press **▶▶1**.

The track numbers are displayed in the programmed order each time the button is pressed.

### ❑ To clear the last track programmed

In the stop mode, press **CLEAR**.

The last track programmed is cleared each time the button is pressed.

### ❑ To clear one programmed track at a time

In the stop mode, press **▶▶1** to select the track to be cleared, then press **CLEAR**.

### ❑ Clearing the all programmed track

In the stop mode, press **PROGRAM**.



- If **REPEAT** is pressed during program playback, the tracks are played repeatedly in the programmed order.
- If **RANDOM** is pressed during program playback, the programmed tracks are played in random order.
- The program is cleared when the disc tray is opened or the power is turned off.

# MP3 and WMA files playback

This section explains how to playback MP3 and WMA files that are recorded onto a CD-R or CD-RW. For details on how to playback files recorded onto media other than CD-R or CD-RW, see the following sections.

- ❑ **Portable audio player playback** (👉 [page 41](#))
- ❑ **USB memory device playback** (👉 [page 40](#))
- ❑ **iPod playback** (👉 [page 37](#))
- ❑ **MP3 and WMA formats** (👉 [page 56](#))

There are many music distribution sites on the Internet allowing you to download music files in MP3 or WMA (Windows Media® Audio) format. The music (files) downloaded from such sites can be stored on CD-R or CD-RW discs and played on this unit.

“Windows Media” and “Windows” are registered trademarks or trademarks in the United States and other countries of Microsoft Corporation of the United States.



## Playing files

**1** Load a CD-R or CD-RW disc containing music files in the MP3 or WMA format into the disc tray (👉 [page 3](#)).

**2** Press **MODE** and select “Folder” or “Disc”.

Folder ↔ Disc

### [About the display]

- When “Folder” is selected:
  - “” is displayed.
- When “Disc” is selected:
  - “” turns off.

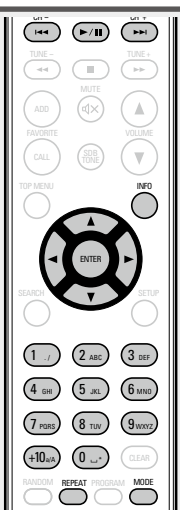

**Folder** All the files in the selected folder are played.

**Disc** After the selected folder and files are played, all the files in all the folders are played.

**3** Use  $\Delta \nabla$  to select the folder to be played.

**4** Use  $\lll, \ggg$  or  $\triangleleft \triangleright$  to select the file to be played.

**5** Press  $\triangleright/\text{II}$ , **ENTER** or  $\triangleright/\text{II}$  **ENTER**.

## ❑ To switch the folder or file during playback

### Folder

Use  $\Delta \nabla$  to select the folder, then press **ENTER** or  $\triangleright/\text{II}$  **ENTER**.

### File

Use  $\triangleleft \triangleright$  to select the file, then press **ENTER** or  $\triangleright/\text{II}$  **ENTER**.

Also use  $\lll, \ggg$  to select the file, or use **0 - 9, +10** to select the file number.

- The folder and file numbers are set automatically when the disc is loaded.



- Copyright-protected files cannot be played.
- Depending on the application software used for writing, it may not be possible to write the data properly.
- Depending on the disc's recording conditions, it may not be possible to play some discs properly.

## ❑ Switching the display

During playback, press **INFO**.

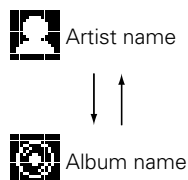

## ❑ To play repeatedly

Press **REPEAT**.

Playback starts in the respective repeat mode.

- The selectable repeat modes differ in the “Folder” and the “Disc”.

When “Folder” is selected:

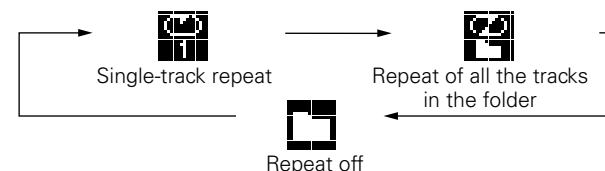

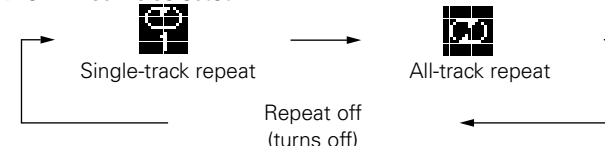

When “Disc” is selected:



### [Selectable items]

When “Folder” is selected:

-  Only the selected track is played repeatedly.
-  All the files in the selected folder are played repeatedly.
-  Folder playback resumes.

When “Disc” is selected:

“Playing repeatedly (Repeat playback)” (👉 [page 26](#))

## ❑ Setting random playback

“Playing random order (Random playback)” (👉 [page 26](#))



Programmed playback is not possible with MP3/WMA discs.

# Network audio playback

Follow this procedure to play Internet radio stations or music files stored on a computer.

- ❑ **About the internet radio function** ([page 58](#))
- ❑ **About Music server** ([page 58](#))
- ❑ **About Last.fm** ([page 58](#))

## Listening to internet radio

### 1 Prepare for playback.

- ① Check the network environment, then turn on this unit's power ([page 23](#) "Turning the power on").
- ② If settings are required, make the "Setting the network [Network]" ([page 17](#)).

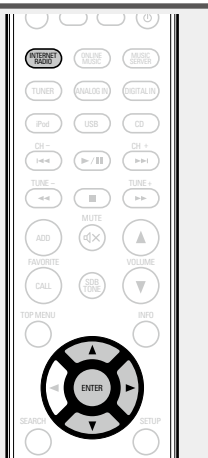

### 2 Press INTERNET RADIO to switch the input source to "Internet Radio".

- For details on selecting the input source using the unit buttons, see "Selecting the input source using the main unit" ([page 23](#)).

### 3 Press $\Delta$ / $\nabla$ to select the item you want to play, then press ENTER or $\triangleright$ .

### 4 Repeat step 3 until the station list is displayed.

The station list is displayed.

- Any characters that cannot be displayed are replaced with "." (period) or " " (space).

### 5 Press $\Delta$ / $\nabla$ to select the station, then press ENTER or $\triangleright$ .

Playback starts once buffering reaches "100%".



- There are many Internet radio stations on the Internet, and the quality of the programs they broadcast as well as the bit rate of the tracks varies widely. Generally, the higher the bit rate, the higher the sound quality, but depending on the communication lines and server traffic, the music or audio signals being streamed may be interrupted. Inversely, lower bit rates mean a lower sound quality but less tendency for the sound to be interrupted.
- "Server Full" or "Connection Down" is displayed if the station is busy or not broadcasting.

### ❑ Switching the display

#### Press INFO during Internet radio reception.

The broadcast station information and signal format bit rate are displayed.



### ❑ Recently played internet radio stations

Recently played internet radio stations can be selected from "Recently Played".  
Up to 20 stations stored in "Recently Played".

### 1 On a top menu of the internet radio station, press $\Delta$ / $\nabla$ to select "Recently Played", then press ENTER or $\triangleright$ .

### 2 Press $\Delta$ / $\nabla$ to select the item you want to play, then press ENTER or $\triangleright$ .

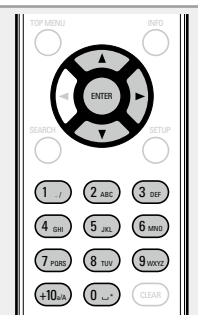

### ❑ Searching stations by keyword (Alphabetic strings)

#### 1 Press $\Delta$ / $\nabla$ to select "Search by Keyword", then press ENTER or $\triangleright$ .

#### 2 Use $\Delta$ / $\nabla$ / $\triangleleft$ / $\triangleright$ or 0 - 9, +10 to input the characters, then press ENTER.

- For character input, see [page 48](#).

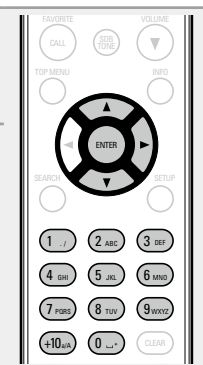

### ❑ Registering internet radio stations as your favorites

You can register your favorite broadcast stations in Favorite List ([page 36](#)).

### ❑ Internet radio operation

Operation buttons	Function
FAVORITE ADD	Registration to the Favorite list
FAVORITE CALL	Call from the Favorite list
$\blacktriangleright$ /II	Stop
SETUP	Menu
$\Delta$ / $\nabla$ / $\triangleleft$ / $\triangleright$	Cursor operation (Up/Down/Left/Right)
ENTER	Enter
SEARCH	Character search*

- \* Press **SEARCH**, then press **ENTER** to select the first letter you want to search mode.



If the list is not in alphabetical order, you may not be able to perform a character search.





## Applying media sharing settings

Here, we apply the settings to share music files stored on a PC and NAS on the network.

### Sharing media stored in PC

If you are using a media server, be sure to apply this setting first.

### When using Windows Media Player 12 (Windows 7)

#### NOTE

Perform this procedure after changing the control panel display to "Category".

- 1** In the PC's "Control Panel", select "Network and Internet" – "Choose homegroup and sharing options".
- 2** Select the "Stream my pictures, music, and videos to all devices on my home network" check box and select "Choose media streaming options".
- 3** Select "Allowed" in the drop-down list for "CEOL".
- 4** Select "Allowed" in the drop-down list for "Media programs on this PC and remote connections...".
- 5** Click "OK" to finish.

### When using Windows Media Player 11

- 1** Start up Windows Media Player 11 on the PC.
- 2** Select "Media Sharing" in the "Library".
- 3** Click the "Share my media" check box, select "CEOL", and then click "Allow".
- 4** As you did in step 3, select the icon of the device (other PCs and mobile devices) you want to use as a media controller, and then click "Allow".
- 5** Click "OK" to finish.

### Sharing media stored in NAS

Change settings on the NAS to allow this unit and other devices (PCs and mobile devices) used as media controllers to access the NAS. For details, see the owner's manual that came with the NAS.

## Playing files stored on a PC and NAS

Use this procedure to play music files or playlists.

### 1 Prepare for playback.

- ① Check the network environment, then turn on this unit's power ([page 23](#) "Turning the power on").
- ② If settings are required, make the "Setting the network [Network]" ([page 17](#)).
- ③ Prepare the computer ([page 30](#) "Applying media sharing settings", [page 58](#) "About Music server").

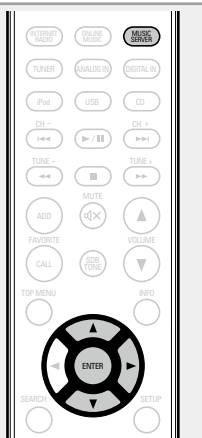

### 2 Press **MUSIC SERVER** to switch the input source to "Music Server".

- For details on selecting the input source using the unit buttons, see "Selecting the input source using the main unit" ([page 23](#)).

### 3 Press $\Delta$ / $\nabla$ to select the server including the file to be played, then press **ENTER** or $\triangleright$ .

### 4 Press $\Delta$ / $\nabla$ to select the search item or folder, then press **ENTER** or $\triangleright$ .

### 5 Repeat step 4 until the file is displayed.

### 6 Press $\Delta$ / $\nabla$ to select the file, then press **ENTER** or $\triangleright$ . Playback starts once buffering reaches "100%".



- Connections to the required system and specific settings must be made in order to play music files ([page 9](#)).
- Before starting, you must launch the computer's server software and set the files as server contents. For details, see the operating instructions of your server software.
- The order in which the tracks/files are displayed depends on the server specifications. If the tracks/files are not displayed in alphabetical order due to the server specifications, searching by the first letter may not work properly.
- WMA Lossless files can be played when using a server supporting transcoding, such as Windows Media Player Ver. 11 or later.

#### NOTE

Particularly when you play back large music files, depending on your wireless LAN environment, the playback sound may be interrupted. In this case, make the wired LAN connection.

### **Playing repeatedly (Repeat playback)**

([page 40](#))

### **Playing random order (Random playback)**

([page 40](#))

### **Switching the display**

During playback, press **INFO**.

- The display switches each time **INFO** is pressed.

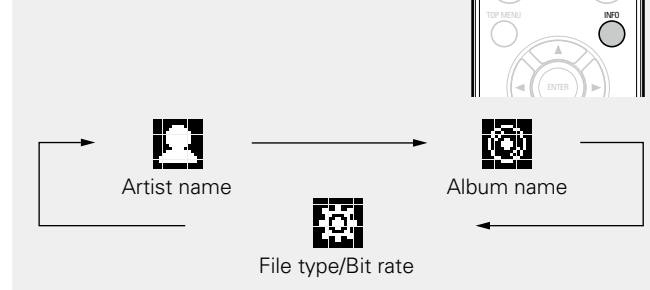

### **Music server operation**

Operation buttons	Function
<b>FAVORITE ADD</b>	Registration to the Favorite list
<b>FAVORITE CALL</b>	Call from the Favorite list
<b>I&lt;&lt;&lt; &gt;&gt;&gt;I</b>	Auto search (cue)
<b>▶/II</b>	Playback / Pause
<b>SETUP</b>	Menu
$\Delta$ / $\nabla$ / $\triangleleft$ / $\triangleright$	Cursor operation ( $\Delta$ / $\nabla$ / $\triangleleft$ / $\triangleright$ ) / Auto search (cue, $\Delta$ / $\nabla$ )
<b>ENTER</b>	Enter
<b>SEARCH</b>	Character search*1
<b>REPEAT</b>	Repeat playback ( <a href="#">page 40</a> )
<b>RANDOM</b>	Random playback ( <a href="#">page 40</a> )*2

\*1 Press **SEARCH**, then press **ENTER** to select the first letter you want to search mode.

\*2 When playing files stored on a computer using the random play function, when a track has finished playing, the next track is selected at random from all of the tracks on the computer. For this reason, the same track may be played back to back.



- If the list is not in alphabetical order, you may not be able to perform a character search.
- Depending on the server being used, some functions may be limited.

## Listening to Last.fm

Last.fm radio is not available in all countries. Please check [www.last.fm/hardware](http://www.last.fm/hardware) for more information. You'll also need a subscription. Get one today at [www.last.fm/subscribe](http://www.last.fm/subscribe).

### 1 Prepare for playback.

- ① Make sure this unit is connected to the Internet, then turn on this unit's power (see [page 23](#) "Turning the power on").
- ② If settings are required, make the "Setting the network [Network]" (see [page 17](#)).



### 2 Press **ONLINE MUSIC** to switch the input source to "Last.fm".

- For details on selecting the input source using the unit buttons, see "Selecting the input source using the main unit" (see [page 23](#)).
- If you do not have a Last.fm account, press  $\nabla$  to select "I am new to Last.fm". Then press **ENTER** or  $\triangleright$ . Create an account in accordance with the instructions on the display.

### 3 If you have a Last.fm account, press $\triangle\nabla$ to select "I have a Last.fm account". Then press **ENTER** or $\triangleright$ .

### 4 Use $\triangle\nabla\triangleright$ to enter your username and password.

- For character input, see [page 48](#).

### 5 After inputting the username and password, select "login", then press **ENTER**.

If the username and password match, the top menu for Last.fm is displayed.

- The types of characters that can be input are as shown below.

<input type="checkbox"/> Username	[Lower case characters] abcdefghijklmnopqrstuvwxyz
	[Upper case characters] ABCDEFGHIJKLMNOPQRSTUVWXYZ
	[Symbols] _ -
	[Numbers] 0123456789
<input type="checkbox"/> Password	[Lower case characters] abcdefghijklmnopqrstuvwxyz
	[Upper case characters] ABCDEFGHIJKLMNOPQRSTUVWXYZ
	[Symbols] ! " # \$ % & ' ( ) * + , - . / : ; < = > ? @ [ \ ] ^ _ ` {   } ~ (Space)
	[Numbers] 0123456789

### 6 Use $\triangle\nabla$ to select menu and then press **ENTER** or $\triangleright$ .

<b>Popular Tags</b>	Play popular tags in your area.
<b>Popular Artists</b>	Play popular artists tags in your area.
<b>Your Recent Stations</b>	Play your recent stations.
<b>Your Recommended Radio</b>	Play your recommended radio.
<b>Your Library</b>	Play your library.
<b>Your Friend's Radio</b>	Play your friend's radio.
<b>Your Top Artists</b>	Play your top Artists.
<b>Search Tag Radio</b>	You can search station by Tag.
<b>Search Artist Radio</b>	You can search station by Artist.

### 7 Use $\triangle\nabla$ to select a station, and press **ENTER**, $\triangleright$ or $\triangleright/\text{II}$ to start playback. Playback starts.

### 8 When you press $\triangleright$ during playback, the following menu appears.

<b>Love this track</b>	Loving tracks improves your Last.fm recommendations, and you can optionally share them on popular social networks.
<b>Ban this track</b>	If you ban a track, we won't play it again. You can undo this on the Last.fm website.
<b>Scrobbling</b>	Scrobbling sends the tracks you played to your Last.fm account. You can see charts of the music you've been listening to, get recommendations for new music and events in your area and share your listening tastes with your friends. You can turn this service on or off using this option. The more you scrobble, the better your recommendations will become.

#### NOTE

The password should be no longer than 90 characters

### Switching the display

**During playback, press INFO.**

The file type/bit rate, artist name and album name are displayed.



### Last.fm operation

Operation buttons	Function
▶/	Playback
▶▶	Auto search (cue)
▶/   ENTER	Stop
SETUP	Menu
△▽◀▶	Cursor operation / Auto search (cue, ▽)
ENTER	Enter



## Tuning in radio stations

Connect the antenna beforehand (page 8).

### Listening to FM broadcasts

**1 Press TUNER to select the reception band.**

**FM** When listening to an FM broadcast.

The reception band can also be selected by pressing **SOURCE** (page 23).

**2 Tune in the desired broadcast station.**

When a station is received, the will light.



**Auto tuning** To tune in automatically.

- 1 Press **MODE**, and "AUTO" lights in the display.
- 2 Press **TUNE +** or **TUNE -** to select the station you want to hear.

**Manual tuning** To tune in manually.

- 1 Press **MODE**, and "AUTO" goes out in the display.
- 2 Press **TUNE +** or **TUNE -** to select the station you want to hear.



- If the desired station cannot be tuned in with auto tuning, tune it in manually.
- When tuning in stations manually, press and hold **TUNE +** or **TUNE -** to change frequencies continuously.

### To stop auto tuning

Press **■**.

## Automatically presetting FM stations (Auto Preset)

This unit can be preset to favorite list with a total of 50, FM broadcast stations.

**1 Press SEARCH.**

"Search" menu appears.

**2 Use △▽ to select "Auto Preset - Start", then press ENTER, ▶/|| ENTER or ▷.**

"Searching" appears in the display, and the unit searches for radio stations. When the search is complete, "Complete!!" appears.



### Canceling auto presetting

Press **■**.

#### NOTE

- Broadcast stations whose antenna signal are weak cannot be preset automatically. If you wish to preset such stations, tune them in manually.
- When all 50 items in the favorite list are registered, no additional registrations can be made.

## RDS (Radio Data System)

Note that the RDS function only works when receiving RDS compatible stations.

RDS (works only on the FM band) is a broadcasting service which allows a station to send additional information along with the regular radio program signal.

The following four types of RDS information can be received with this unit:

### ❑ RDS Search

Use this function to automatically tune to FM stations that provide the RDS service.

#### 1 Press **TUNER** to switch the input source to “TUNER (FM)”.

- For details on selecting the input source using the unit buttons, see “Selecting the input source using the main unit” (page 23).

#### 2 Press **SEARCH**.

#### 3 Use $\Delta$ / $\nabla$ to select “RDS Search”, then press **ENTER**, $\blacktriangleright$ /**ENTER** or $\blacktriangleright$ .

Automatically begin the RDS search operation.

- If no RDS station is found, “No Programme” is displayed.

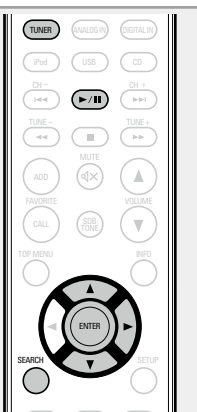

### Viewing information during reception

Press **INFO** while receiving a RDS to display the information currently being broadcast.

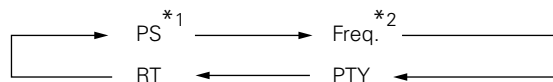

- \*1 Program service name
  - If a station name is entered, it is displayed.
- \*2 Frequency

## PTY (Program Type)

PTY identifies the type of RDS program. The program types and their displays are as follows:

<b>NEWS</b>	News	<b>WEATHER</b>	Weather
<b>AFFAIRS</b>	Current Affairs	<b>FINANCE</b>	Finance
<b>INFO</b>	Information	<b>CHILDREN</b>	Children's programmes
<b>SPORT</b>	Sports	<b>SOCIAL</b>	Social Affairs
<b>EDUCATE</b>	Education	<b>RELIGION</b>	Religion
<b>DRAMA</b>	Drama	<b>PHONE IN</b>	Phone In
<b>CULTURE</b>	Culture	<b>TRAVEL</b>	Travel
<b>SCIENCE</b>	Science	<b>LEISURE</b>	Leisure
<b>VARIED</b>	Varied	<b>JAZZ</b>	Jazz Music
<b>POP M</b>	Pop Music	<b>COUNTRY</b>	Country Music
<b>ROCK M</b>	Rock Music	<b>NATION M</b>	National Music
<b>EASY M</b>	Easy Listening Music	<b>OLDIES</b>	Oldies Music
<b>LIGHT M</b>	Light Classical	<b>FOLK M</b>	Folk Music
<b>CLASSICS</b>	Serious Classical	<b>DOCUMENT</b>	Documentary
<b>OTHER M</b>	Other Music		

### ❑ PTY Search

Use this function to find RDS stations broadcasting a designated program type (PTY). For a description of each program type, refer to “PTY (Program Type)”.

#### 1 Press **TUNER** to switch the input source to “TUNER (FM)”.

- For details on selecting the input source using the unit buttons, see “Selecting the input source using the main unit” (page 23).

#### 2 Press **SEARCH**.

#### 3 Use $\Delta$ / $\nabla$ to select “PTY Search”, then press **ENTER**, $\blacktriangleright$ /**ENTER** or $\blacktriangleright$ .



#### 4 Use $\Delta$ / $\nabla$ to call out the desired program type, then press **ENTER**, $\blacktriangleright$ /**ENTER** or $\blacktriangleright$ . Automatically begin the PTY search operation.

- If no program of the specified type is found, “No Programme” is displayed.

## TP (Traffic Program)

TP identifies programs that carry traffic announcements. This allows you to easily find out the latest traffic conditions in your area before leaving home.

### ❑ TP Search

Use this function to find RDS stations broadcasting traffic programs (TP stations).

#### 1 Press **TUNER** to switch the input source to “TUNER (FM)”.

- For details on selecting the input source using the unit buttons, see “Selecting the input source using the main unit” (page 23).

#### 2 Press **SEARCH**.

#### 3 Use $\Delta$ / $\nabla$ to select “TP Search”, then press **ENTER**, $\blacktriangleright$ /**ENTER** or $\blacktriangleright$ .

Automatically begin the TP search operation.

- “No Programme” is displayed when there is no traffic information broadcast station.



## RT (Radio Text)

RT allows RDS stations to send text messages that appear on the display.



- When the RT mode is turned on while an RDS broadcast station not offering an RT service is tuned in, "NO TEXT" is displayed on the display.
- The RT mode cannot be set in the FM stations not offering RDS broadcasts.

### NOTE

The operations described below selecting "RDS Search" will not function in areas in which there are no RDS broadcasts.

## □ Tuner (FM) operation

Operation buttons	Function
<b>FAVORITE ADD</b>	Registration to the Favorite list
<b>FAVORITE CALL</b>	Call from the Favorite list
<b>■</b>	Stop
<b>TUNER +, -</b>	Tuning (up/down)
<b>SETUP</b>	Menu
<b>MODE</b>	Switch search modes
<b>△▽◀▶</b>	Cursor operation (Up/Down/Left/Right)
<b>ENTER</b>	Enter
<b>SEARCH</b>	RDS search / PTY search / TP search / Auto preset
<b>TOP MENU</b>	Return to top page





## Favorite function

This section provides information on the Favorite function.

- The Favorite function allows you to register your favorite broadcast stations and files in Favorite List in advance so that you can call and listen to the stations or files right away, whenever you want.
- The contents that you can register and call are Internet radio station, music server and tuner.
- You can register up to 50 items in Favorite List.

### Registering stations or files to the favorites list

- 1 Press FAVORITE ADD while the Internet radio station or file to register is played back.**  
“Favorite” menu appears.



- 2 Press  $\Delta$ / $\nabla$  to select a number to register the station or file, and press ENTER.**  
“Add to Favorite” is displayed and the registration is completed.

### Calling stations or files from the favorites list

- 1 Press FAVORITE CALL.**  
The Favorite list appears.
- 2 Press  $\leftarrow\leftarrow\rightarrow\rightarrow$  or  $\Delta$ / $\nabla$  to select the station or file that you want to call, and press ENTER.**  
The respective function starts up and playback starts.

- Press **0–9, +10** to call files registered to the Favorite list by number.



- To switch between registered stations and files during playback**  
Press  $\leftarrow\leftarrow\rightarrow\rightarrow$  or  $\Delta$ / $\nabla$ .

### Deleting stations or files from the favorite list

- 1 Press FAVORITE CALL.**  
The Favorite list appears.
- 2 Press  $\Delta$ / $\nabla$  to select the station or file that you want to delete, and press CLEAR.**
- 3 When the prompt “Delete?” appears, press ENTER.**  
“Deleted” is displayed and the deletion is completed.

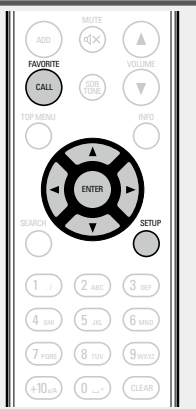

- To cancel the operation**  
Press  $\leftarrow$ .

## iPod playback

The unit can play back music stored on iPod, iPod touch, iPod classic, iPod nano and iPhone.

☐ [iPod](#) (page 56)

### Connecting an iPod

#### ☐ iPod Dock

Open the lid and mount the adapter suited for your iPod onto the dock adapter included with your iPod.

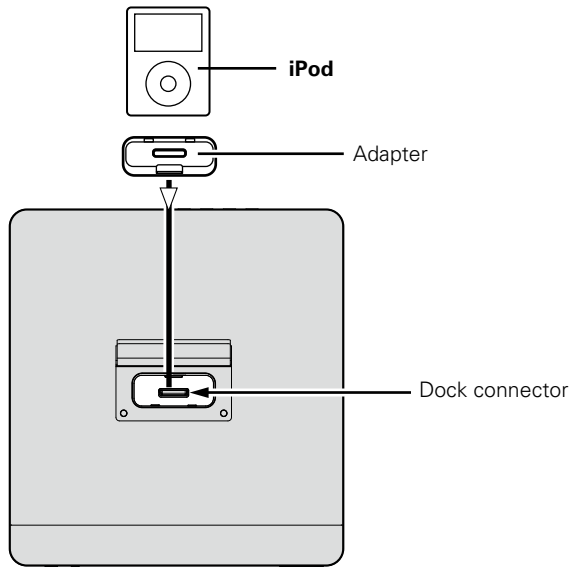

#### NOTE

- Please make sure to fit adaptor to connector part for use with your iPod.
- When plugging in or unplugging the iPod, please proceed carefully, adjusting the inclination of the connector so as not to place a burden upon the connector.

#### Loading

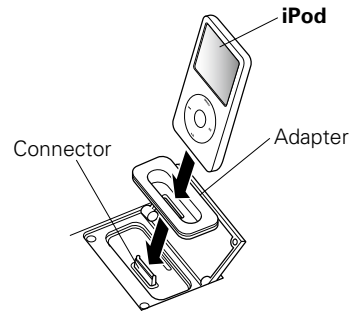

#### Dismantling

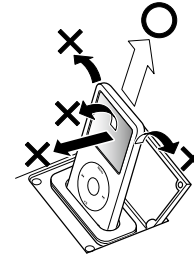

#### ☐ USB port

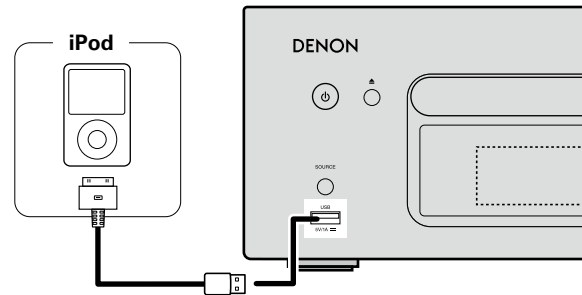

To connect an iPod to this unit, use the iPod cable supplied with the iPod.



## Playing an iPod

**1** Press **POWER**  to turn on power to the main unit.

**2** Press **iPod** to switch the input source to “iPod”.

- For details on selecting the input source using the unit buttons, see “Selecting the input source using the main unit” ([page 23](#)).

**3** Press **MODE** to select the display mode.

The display mode switches each time **MODE** is pressed.

- There are two modes for displaying the contents recorded on the iPod.

**Browse mode** Display iPod information on the display of this unit.

**Remote mode** Display iPod information on the iPod screen.

- “Remote iPod” is displayed on the display of this unit.



Display mode		Browse mode	Remote mode
Display location		Main unit display	iPod display
Playable files	Audio file	✓	✓
	Video file		✓*
Active buttons	Remote control and main unit	✓	✓
	iPod		✓

\* Only audio is played back.

- The default display mode setting is “Remote mode”.









**4** Use  $\triangle$ / $\nabla$  to select the item, then press **ENTER** to select the music file to be played.

**5** Press **▶/||**. Playback starts.

### NOTE

- 1st generation iPod nano and iPod video do not have remote mode support.
- DENON will accept no responsibility whatsoever for any loss of iPod data.
- Depending on the type of iPod and the software version, some functions may not operate.

### Remote control and iPod button relations

Remote control buttons	iPod buttons	Operation on this unit
		Play the track from the beginning/Play the next track
		Play the track / Pause the track
 (Press and hold)	 (Press and hold)	Fast-reverse the track/Fast-forward the track
<b>MODE</b>	–	Switch between the browse mode and the remote mode
$\triangle$ / $\nabla$	Click Wheel	Cursor operation (up/down)
	<b>MENU</b>	Display the menu or return to the previous menu
<b>ENTER</b> or 	Select	Enter the selection or plays the track
<b>REPEAT</b>	–	Switch the repeat function
<b>RANDOM</b>	–	Switch the shuffle function

### Switching the display

During playback, press **INFO**.

- The display switches each time **INFO** is pressed (Browse mode only).

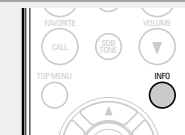

Artist name



Album name

### Playing repeatedly (Repeat playback)

([page 40](#))

(Browse mode only)

### Playing random order (Random playback)

([page 40](#))

## Disconnecting the iPod

**1** Press **POWER**  to set the standby mode.

**2** Disconnect the iPod from the Dock connector.



## Charging the iPod

You can charge your iPhone/iPod by connecting it to the dock connector or USB port.

### Standby charging

If the unit enters power standby mode while the iPod/iPhone is charging, the unit will switch to standby charging mode, and the iPod/iPhone will continue to be charged. When in standby charging mode, the power display light turns red.

When the iPhone/iPod is fully charged, the unit automatically stops supplying power for charging and enters normal power standby mode, and the power display light turns off.



If an iPhone/iPod is connected to the dock connector while the unit is in power standby mode, the unit will enter standby charging mode and begin charging the iPhone/iPod.

## Supported iPod models

### • iPod classic



iPod classic  
80GB



iPod classic  
160GB (2007)



iPod classic  
160GB (2009)

### • iPod nano



iPod nano  
3rd generation  
(video)  
4GB 8GB



iPod nano  
4th generation (video)  
8GB 16GB



iPod nano  
5th generation (video camera)  
8GB 16GB



iPod nano  
6th generation  
8GB 16GB

### • iPod touch



iPod touch  
1st generation  
8GB 16GB 32GB



iPod touch  
2nd generation  
8GB 16GB 32GB



iPod touch  
3rd generation  
32GB 64GB



iPod touch  
4th generation  
8GB 32GB 64GB

### • iPhone



iPhone  
4GB 8GB 16GB



iPhone 3G  
8GB 16GB



iPhone 3GS  
8GB 16GB 32GB



iPhone 4  
8GB 16GB 32GB



iPhone 4S  
16GB 32GB 64GB

(as of July 2012)

## USB memory device playback

You can playback music stored on a USB memory device using this unit.

□ **USB memory device** (🔗 [page 57](#))

### Playing files stored on USB memory devices

#### 1 Connect the USB memory device to the USB port.

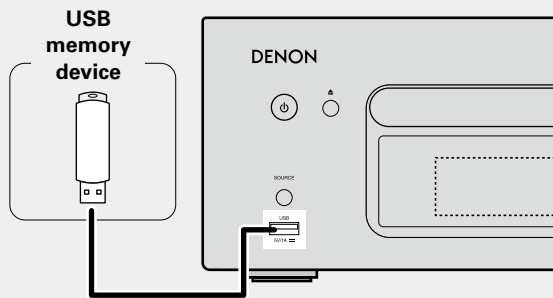

#### 2 Press **POWER** to turn on power to the main unit.

#### 3 Press **USB** to switch the input source to “USB”.

• For details on selecting the input source using the unit buttons, see “Selecting the input source using the main unit” (🔗 [page 23](#)).

#### 4 Press $\Delta/\nabla$ to select the file or folder, then press **ENTER** or $\triangleright$ .

#### 5 Press $\Delta/\nabla$ to select the file, then press **ENTER**, $\triangleright$ or $\blacktriangleright/\parallel$ . Playback starts.



- If the USB memory device is divided into multiple partitions, only the top partition can be selected.
- This unit is compatible with MP3 files conforming to “MPEG-1 Audio Layer-3” standards.
- DENON does not guarantee that all USB memory devices will operate or receive power. When using a portable USB connection type HDD of the kind to which an AC adapter can be connected to supply power, use the AC adapter.

#### NOTE

- USB memory devices will not work via a USB hub.
- It is not possible to connect and use a computer via the USB port of this unit using a USB cable.
- Do not use an extension cable when connecting a USB memory device. This may cause radio interference with other devices.
- Note that DENON will accept no responsibility whatsoever for any problems arising with the data on a USB memory device when using this unit in conjunction with the USB memory device.

### Removing the USB memory device

#### 1 Press **POWER** to set the standby mode.

#### 2 Check that the communication indicator on the USB memory device is not flashing, then pull out the USB memory device.



#### NOTE

Do not remove the USB memory device from the unit when the USB memory communication indicator is flashing. Doing so may damage the USB memory device, or may corrupt the files recorded on the USB memory device.

### Playing repeatedly (Repeat playback)

#### Press **REPEAT**.

Repeat playback starts.

- Each time you press **REPEAT**, the repeat mode is toggled as shown below.

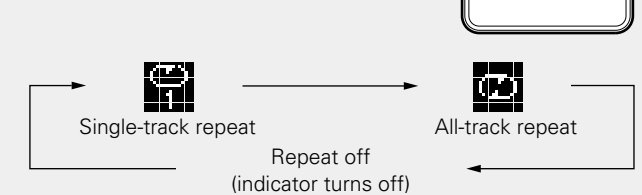

	(Single-track repeat)	Only 1 track plays repeatedly.
	(All-track repeat)	All tracks within the current playback folder are repeated.
	Repeat off (indicator turns off)	Normal playback resumes.

### Playing random order (Random playback)

#### Press **RANDOM**.

The indicator lights in the display, and random playback starts.



#### □ **Canceling random playback**

Press **RANDOM**.

The indicator on the display turns off.

## USB operation

Operation buttons	Function
◀▶, ⏪, ⏩	Auto search (cue)
▶/II	Playback / Pause
△▽	Cursor operation / Auto search (cue, △▽)
ENTER or ▷	Enter / Playback
◀	Display the menu or return to the previous menu
SEARCH	Character search*1
REPEAT	Repeat playback
RANDOM	Random playback*2

- \*1 Press **SEARCH**, then press **ENTER** to select the first letter you want to search mode.
- \*2 When playing files stored on a USB memory device using the random play function, when a track has finished playing, the next track is selected at random from all of the tracks on the device. For this reason, the same track may be played back to back.



If the list is not in alphabetical order, you may not be able to perform a character search.



## Switching the display

During playback, press **INFO**.

- The display switches each time **INFO** is pressed.

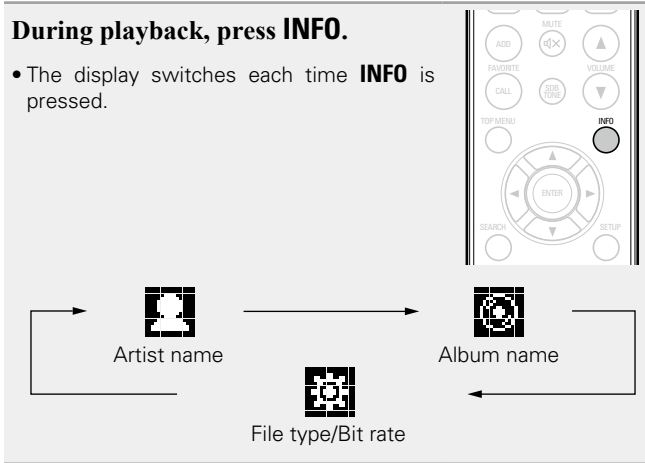

## Portable audio player playback

Your portable audio player can be connected to this unit's portable jack to play tracks on the portable audio player.

### Playing portable audio player

- 1 Connect the portable audio player to** (see [page 7](#) “Connecting a portable player”). The input source automatically switches to “Portable In”.
- 2 Play the portable audio player.** The player's audio is output.
  - Also read the portable audio player's operating instructions.

#### NOTE

When using the portable player's headphone jack, set the volume on the portable player to an appropriate level.



## Listening to ANALOG IN

- 1 Prepare for playback.** Check the connection, then turn on this units.



- 2 Press ANALOG IN to select “Analog In 1”, “Analog In 2” or “Portable In”.**

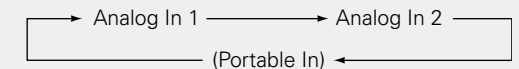

- When there is no portable audio player connected to the portable in jack, “Portable In” is not displayed when you press **ANALOG IN**.

- 3 Play the component connected to this unit.**



## Listening to DIGITAL IN

**1 Prepare for playback.**  
Check the connection, then turn on this unit.

**2 Press DIGITAL IN to select “Digital In”.**

**3 Play the component connected to this unit.**

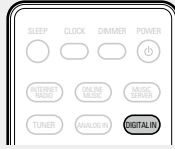

### NOTE

Other digital audio signals than 2 channel linear PCM cannot be input through DIGITAL IN connector of this unit.

## AirPlay function

Enjoy music from your iTunes library with DENON quality sound anywhere in your home.

### Streaming music stored in iPhone or iPod touch directly to the unit

If you update your "iPhone/iPod touch" to iOS 4.2.1 or later, you can stream music stored in your "iPhone/iPod touch" directly to this unit.

- 1 **Start the music mode on the iPhone or iPod touch.**  
 is displayed on the iPhone or iPod touch screen.

- 2 **Tap the AirPlay icon .**  
Set "Network Control" ([page 20](#)) to "On" for this unit.

#### NOTE

When "Network Control" is set to "On", the unit consumes more standby power.

- 3 **Select the speaker you want to use.**

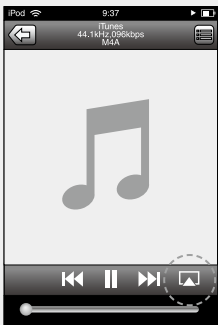

### Playing iTunes music on this unit

- 1 **Install iTunes 10, or later, on a Mac or PC that is connected to the same network as this unit.**

- 2 **Turn this unit ON.**  
Set "Network Control" ([page 20](#)) to "On" for this unit.

#### NOTE

When "Network Control" is set to "On", the unit consumes more standby power.

- 3 **Launch iTunes and click the AirPlay icon  displayed in the lower right of the window and select this unit from the list.**

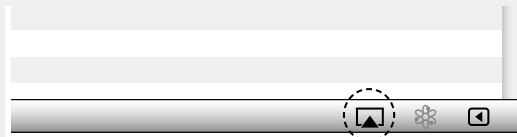

- 4 **Choose a song and click play in iTunes.**  
The music will stream to this unit.

### Multiple speakers

You can easily stream music from iTunes to multiple speakers in your home.

- 1 **Click the AirPlay icon  and select "Multiple Speakers" from the list.**

- 2 **Check the speakers you want to use.**

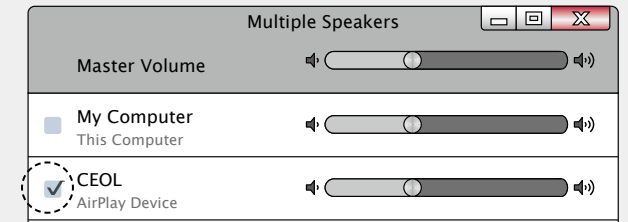

## Remote operations

You can use your DENON remote control to play and pause iTunes, as well as skip to next and previous tracks.

**1** Open “Edit” – “Preferences” in iTunes, and click “Devices”.

**2** Check “Allow iTunes audio control from remote speakers”.

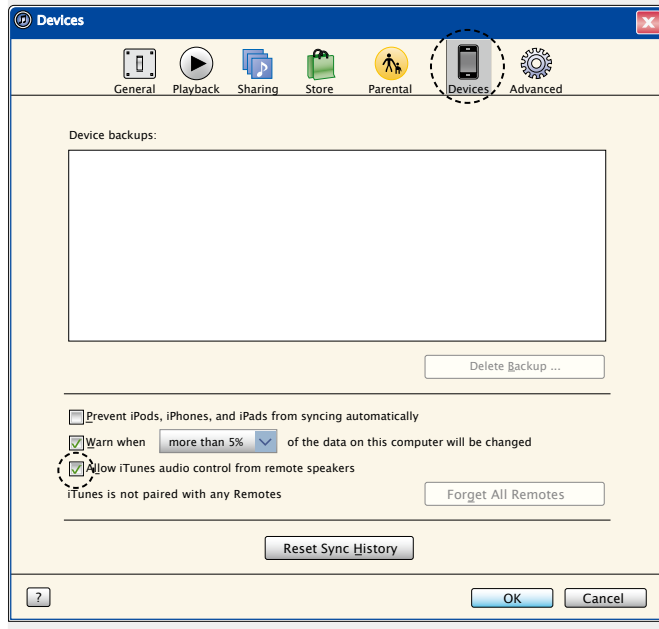

- Source input will be switched to “AirPlay” when AirPlay playback is started.
- You can stop AirPlay playback by pressing the ◀ or choosing other input source.
- To see artist name or album name together, press **INFO**.
- For information about how to use iTunes, also see the Help for iTunes.
- The screen may differ depending on the OS and software versions.
- When you connect iPod to the USB connector during AirPlay playback, AirPlay playback stops.

## Remote play function

You can use your home network to play back with this unit music files stored on PC, NAS, mobile phones and portable audio players. In this case, you use PC, mobile phones and portable audio players for operations.



- The relevant devices should comply with the DLNA (Digital Living Network Alliance) Ver. 1.5 standard.
- A wireless LAN environment is required for playing back music files on mobile phones or portable audio players.
- For some mobile phones, you must install an application for DLNA music playback.

### Roles each device plays

The following devices are used for Remote Play. As specified in the DLNA standard, these devices are called DMC, DMS or DMR according to their role.

Name	Device example	Role
<b>DMC</b> (Digital Media Controller)	<ul style="list-style-type: none"><li>• PC</li><li>• Mobile phone</li><li>• Portable audio player</li></ul>	Performs Remote Play operations. DMC can also play back music files stored on these devices.
<b>DMS</b> (Digital Media Server)	<ul style="list-style-type: none"><li>• PC</li><li>• NAS (Network Attached Storage)</li></ul>	Stores music files. Music files stored on these devices are played back with DMC.
<b>DMR</b> (Digital Media Renderer)	<ul style="list-style-type: none"><li>• This unit</li></ul>	Outputs audio of music files played back through Remote Play from speakers. DMR cannot perform playback operations.

### Files that can be played back

See "About Music server" ([page 58](#)).

## Settings required for each device

You must make settings on DMC and DMS for Remote Play. Make the following settings. Also see the owner's manual of each device for settings.

### Settings on PC and NAS

Make settings on PC and NAS to exchange data with DMR devices. For settings, see "Applying media sharing settings" ([page 30](#)).

### Settings on mobile phones

You must install an application for DLNA music playback on your mobile phone to perform operations on DMS and this unit (DMR) with your mobile phone. The applicable application differs according to your mobile phone.



Some mobile phones support DLNA music playback with the factory settings. See the owner's manual of your mobile phone.

### Settings on portable audio players

Make settings so that this unit (DMR) can play back music files stored on your portable audio player. For settings, see the owner's manual of your portable player.

### Settings on this unit

Connect this unit to the DLNA network. You do not need to make other settings.

For the network connection, see the provided Quick setup Guide, "Connecting to a home network (LAN)" ([page 9](#)) and "Setting the network [Network]" ([page 17](#)).

### Remote Play operations

Operations are different for each device, but the procedures for preparing for Remote Play are the same. The preparation procedures are shown below.

- 1 Turn on this unit.**
  - Make sure that this unit is connected to the network.
- 2 Display the music file playback screen on DMC.**
  - For PC, open Windows Media Player 12, etc.
  - For mobile phones, switch to the music file playback mode.
- 3 Select the friendly name of this unit for the item that sets the playback device on the playback screen.**
  - The default friendly name of this unit is "CEOL".
- 4 Start playing back a music file on DMC.**
  - The function on this unit automatically switches to Music Server and the Remote Play mark () appears on the display. Remote Play starts.

### NOTE

During Remote Play, you cannot perform playback operations with this unit. Use the DMC device for these operations.

### To exit Remote Play

- Press .
- The Remote Play mode ends.



## Web control function

You can control this unit from a web control screen on a web browser.



- This unit and the PC need to be connected to the network properly (🔗 [page 9](#) “Connecting to a home network (LAN)”) in order to use the web control function.
- Depending on the settings of your security-related software, you may not be able to access this unit from your PC. If this is the case, then change the settings of the security-related software.

**1** Switch the “Network Control” setting to “On” (🔗 [page 20](#)).

**2** Check the IP address of this unit with “Network Information”.



Checking the IP address.

**3** Start up the web browser.

**4** Enter the IP address of this unit in browser’s address box.

For example, if the IP address of this unit is “192.168.100.19”, enter “http://192.168.100.19/”.

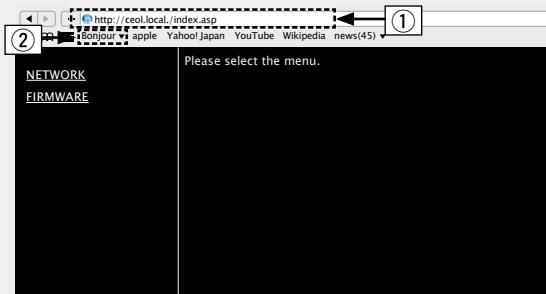

① Entering the IP address.

- By adding this unit’s IP address to the browser’s bookmark, you can display the web control screen using the bookmark function the next time you use the browser. If you are using a DHCP server and “Network Control” (🔗 [page 20](#)) is set to “Off”, turning the power on/off changes the IP address.

② If you are using the Safari web browser, you can select “Bonjour” and directly access the unit’s web control screen from the overview section.

**5** When the top menu is displayed, click on the menu item you want to operate.

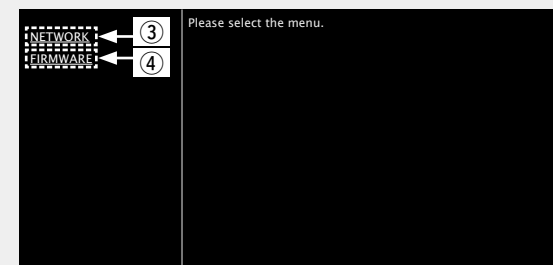

③ Click when you setup network settings. (🔗 [Example 1](#))

④ Click when you update firmware (🔗 [page 15](#))

## 6 Operate.

### [Example 1] Network Setting 1

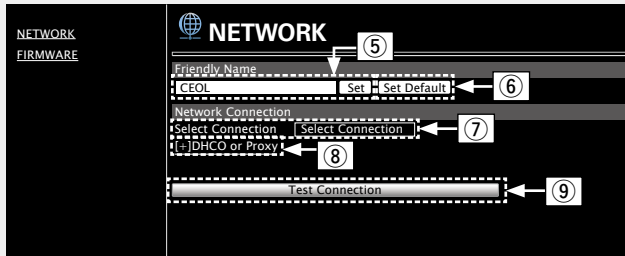

#### Friendly Name setting

- ⑤ To change the Friendly Name, enter the new name in the text box and click “Set”.
- ⑥ To reset the Friendly Name, click “Set Default”.

#### Network connection settings

- ⑦ Click to change the network connection method. If you select “Wi-Fi”, a new item will appear on-screen.  
(☞ [Example 2])
- ⑧ Click to change DHCP/proxy settings.  
(☞ [Example 2])
- ⑨ Click to connect using the newly applied settings.

#### NOTE

To apply network connection settings, click “Test Connection” after making changes.

## 7 Operate.

### [Example 2] Network Setting 2

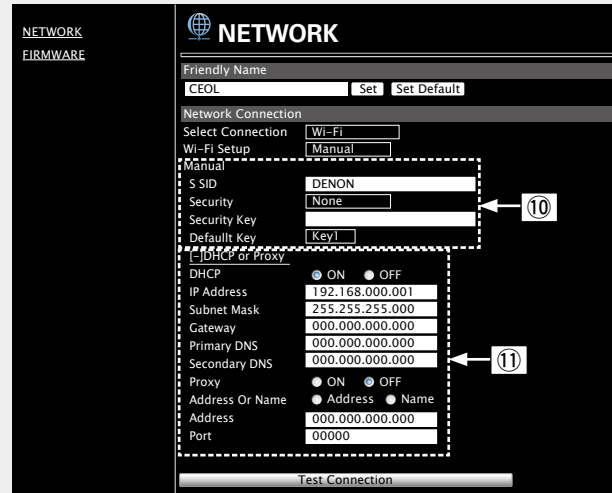

#### Network connection settings

- ⑩ Various items will be displayed if you selected “Wi-Fi” in Example 1. Select or input items as necessary, and then click “Test Connection” to apply the changes.

#### NOTE

- Items displayed may vary depending on selected items and connection status.
  - After selecting each item, wait a moment for the display to be updated.
- ⑪ Displayed if “DHCP” or “Proxy” is selected in Example 1. When changing DHCP/proxy settings, input or select for each item.

#### NOTE

To apply network connection settings, click “Test Connection” after making changes.

## Other functions

### Inputting characters

On this unit, the names displayed for "Friendly Name" and search screens can be changed as desired.

For inputting characters, there are two methods, as shown below.

Method	Operations
<b>Using the number buttons</b>	<ul style="list-style-type: none"> <li>Operating with the remote control.</li> <li>Multiple characters are assigned to a button, and each time the button is pressed, a character is switched.</li> </ul>
<b>Using the cursor buttons</b>	<ul style="list-style-type: none"> <li>Operating with the remote control or the main unit.</li> <li>Use <math>\Delta</math> <math>\nabla</math> <math>\triangleleft</math> <math>\triangleright</math> and <b>ENTER</b> to input characters.</li> </ul>

#### □ Display of an input screen

[Friendly name input]



### Using the number buttons

**1** Display the screen for inputting characters.

**2** Place the cursor at the character to be changed with  $\triangleleft$   $\triangleright$  and press **0 – 9, +10** until the desired character is displayed.



• The types of characters that can be input are as shown below.

1 ., /	1. @ - _ / : ~	6 MNO	m n o M N O 6
2 ABC	a b c A B C 2	7 PQRS	p q r s P Q R S 7
3 DEF	d e f D E F 3	8 TUV	t u v T U V 8
4 GHI	g h i G H I 4	9 WXYZ	w x y z W X Y Z 9
5 JKL	j k l J K L 5	0 ., /	0 (Space) ! " # \$ % & ' ( ) * + , ; < = > ? [ \ ] ^ ` {   }

- The input character type can be switched by pressing **+10** while the display name is being changed.
- Press **CLEAR** to delete the character.
- For entering the characters assigned to one number button continuously, press  $\triangleright$  to move the cursor to the right after entering a character then enter the next character.
- For entering characters assigned to separate buttons, press the number button continuously. The cursor automatically moves to the next position, and the entered character is registered.

**3** Repeat step 2 to change the name then press **ENTER** to register it.

**Example:** For changing characters from "POPS" to "ROCK"

- ① Place the cursor at "P". ▶ P O P S
- ② Press **7** (PQRS) seven times. ▶ R O P S  
"P" changes to "R".
- ③ Press  $\triangleright$  twice. ▶ R O P S  
"R" is automatically registered, and the cursor placed "P".
- ④ Press **2** (ABC) six times. ▶ R O C S  
"P" changes to "C".
- ⑤ Press  $\triangleright$ . ▶ R O C S  
"C" is registered and the cursor placed "S".
- ⑥ Press **5** (JKL) five times. ▶ R O C K  
"S" changes to "K".
- ⑦ Press **ENTER** to register the input name.

## Using the cursor buttons

- 1 Display the screen for inputting characters.
- 2 Use ◀ ▶ to set the cursor to the character you want to change.
- 3 Use ▲ ▼ to change the character.

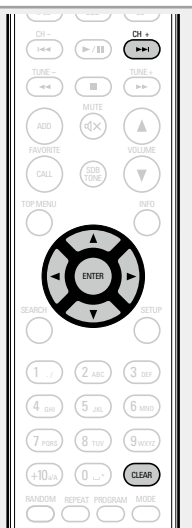

- The types of characters that can be input are as shown below.

### [Lower case characters]

abcdefghijklmnopqrstuvwxyz

### [Upper case characters]

ABCDEFGHIJKLMNOPQRSTUVWXYZ

[Symbols] ! " # \$ % & ' ( ) \* + , - . / : ; < = > ? @ [ \ ] ^ \_ ` { | } ~

[Numbers] 0 1 2 3 4 5 6 7 8 9 (Space)

- The input character type can be switched by pressing **+10** while the display name is being changed.
- Press **CLEAR** to delete the character.
- Press **▶▶I** to insert a space.

- 4 Repeat steps 2 and 3 to change the name then press **ENTER** to register it.

## Auto power on function

When you press **INTERNET RADIO, ONLINE MUSIC, MUSIC SERVER, TUNER, iPod, USB, CD, ▶/II, ▲** or **FAVORITE CALL**, the corresponding device is turned on and the source automatically switches.

- When you press ▶/II, the previously selected source is played back.
- When you press ▲, the disc tray opens.

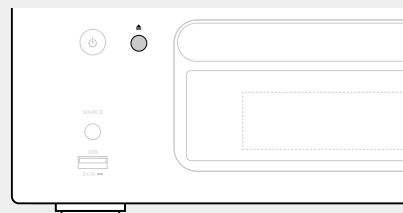
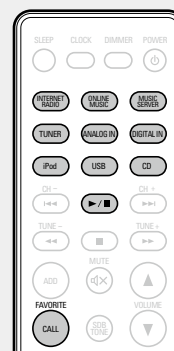

## Last function memory

This stores the settings as they were immediately before going into the standby mode.

When the power is turned back on, the settings are restored to as they were immediately before going into the standby mode.

## Resetting the microprocessor

Perform this procedure if the display is abnormal or if operations cannot be performed.

When the microprocessor is reset, all the settings are reset to their default values.

- 1 Pull the power cord out of the power outlet.
- 2 Plug the power cord into a power outlet while pressing **VOLUME ▲▼** on the main unit.

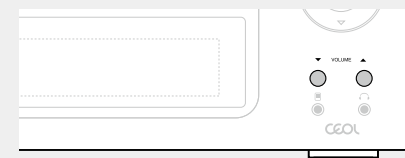

- 3 When the power indicator lights white, release the buttons.  
"Initialized" appears in the display.







If "Initialized" does not display in step 3, start over from step 1.

## Information

---

Here, we list various information related to this unit.  
Please refer to this information as needed.

- Information  [page 51](#)
- Explanation terms  [page 59](#)
- Troubleshooting  [page 61](#)
- Specifications  [page 65](#)
- Index  [page 66](#)

# Information

## Part names and functions

For buttons not explained here, see the page indicated in parentheses ( ).

### Front panel

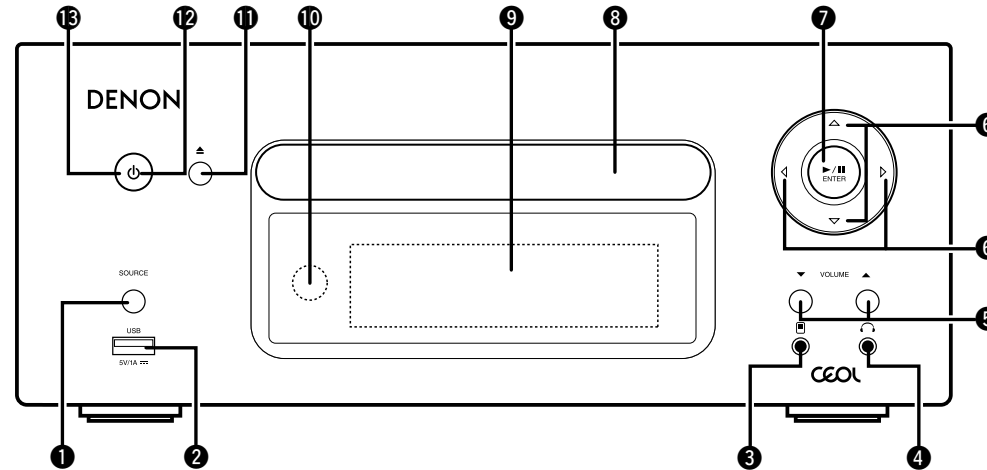

- |  |   |  |
|--|---|--|
| <b>1 SOURCE button</b> ..... (23)<br>Selects the input source.   | <b>5 Volume up/down button (VOLUME ▲▼)</b> ..... (23)<br>Adjusts the audio volume.        | <b>12 Power indicator</b> ..... (23)   |
| <b>2 USB port</b> ..... (37, 40)<br>Used to connect iPod or USB memory devices.                          | <b>6 Cursor button (△▽◀▶)</b> ..... (12, 23)  | <b>13 Power operation button and indicator (⏻)</b> ..... (23)<br>Turns power to this unit on and off (standby).<br>The power indicator changes as shown below according to the status of the unit.<br>• Power on : White<br>• Standby : Off<br>• Network Control – “On” : Red<br>• iPod charge standby : Red<br>• Alarm standby : Orange |
| <b>3 Portable in jack (📀)</b> ..... (41)<br>Used to connect portable audio devices.                      | <b>7 Play/Pause/ENTER button (▶/⏸/ENTER)</b> ..... (25)                                   |  |
| <b>4 Headphones jack (🎧)</b> ..... (24)<br>Used to connect headphones.                                   | <b>8 Disc tray</b> ..... (3, 25)<br>Tray used to insert a compact disc.                   |  |
| <b>NOTE</b><br>To prevent hearing loss, do not raise the volume level excessively when using headphones. | <b>9 Display</b><br>Displays play status, settings, etc.                                  |  |
|  | <b>10 Remote control sensor</b> ..... (4)   |  |
|  | <b>11 Disc tray open/close button (⏏)</b> ..... (25)<br>Used to open/close the disc tray. |  |

## Top panel

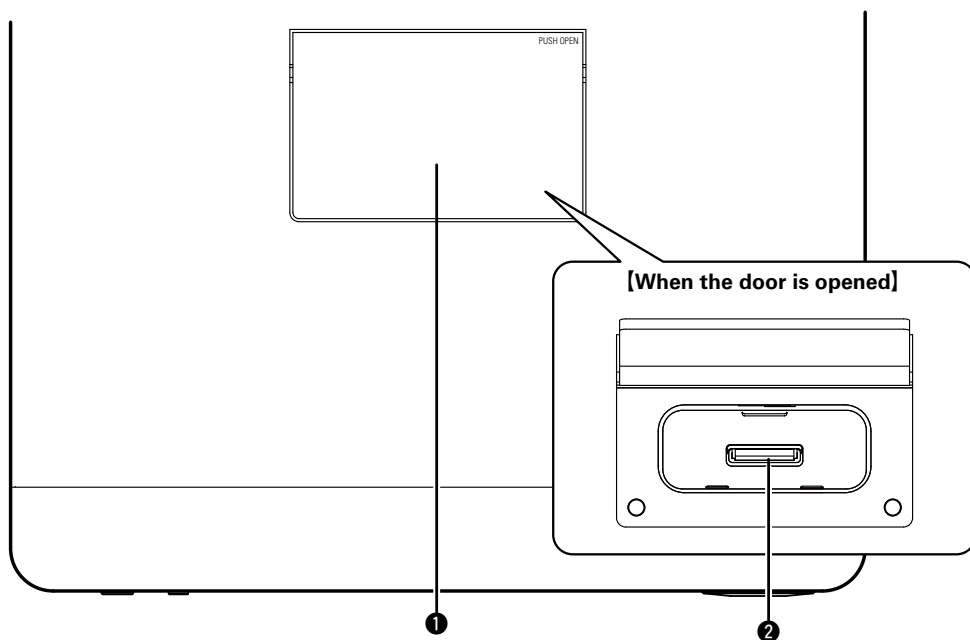

- ❶ Door ..... (37)
- ❷ Dock connector ..... (37)

## Rear panel

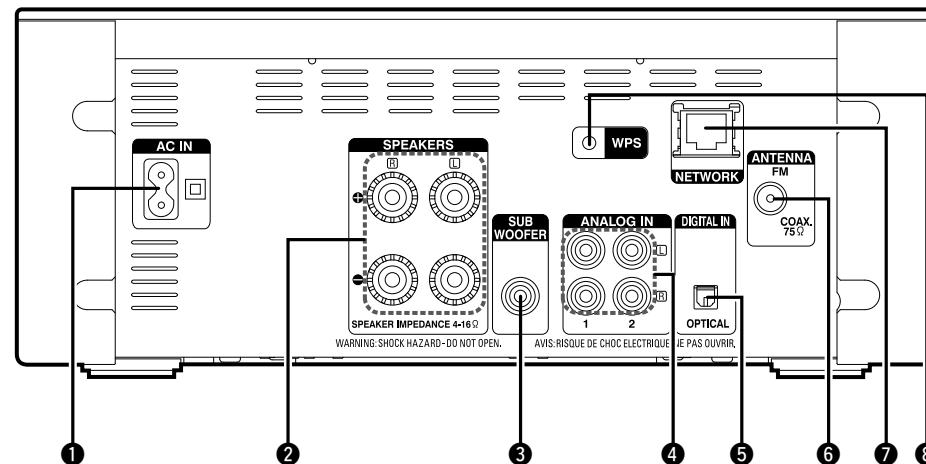

- ❶ AC inlet (AC IN) ..... (10)
- ❷ Speaker terminals (SPEAKERS) ..... (6)
- ❸ SUBWOOFER connector ..... (6)
- ❹ ANALOG IN connectors ..... (7)
- ❺ DIGITAL IN connector ..... (7)
- ❻ FM antenna terminal (ANTENNA) ..... (8)
- ❼ ETHERNET connector (NETWORK) ..... (9)
- ❽ WPS button ..... (19)

## Remote control

This section explains the buttons used to playback each input source.

### Buttons that work with all input sources

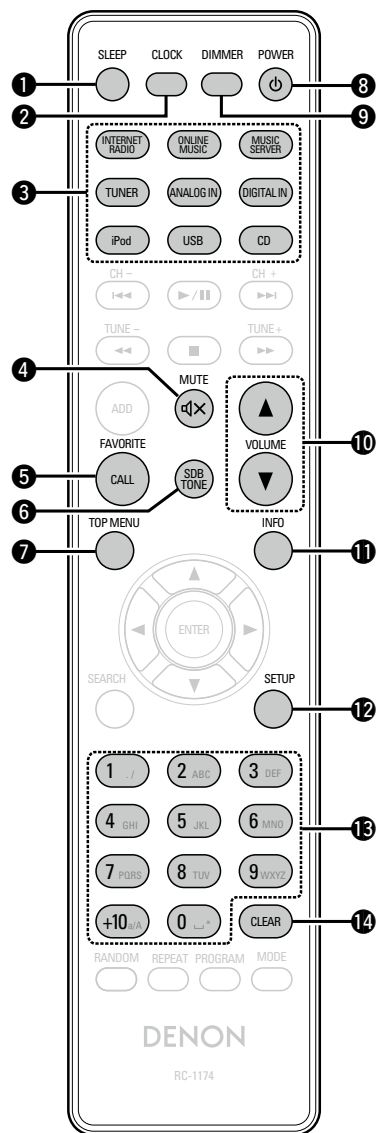

- 1 SLEEP button ..... (24)
- 2 CLOCK button ..... (13)
- 3 Input source select buttons ..... (23)
- 4 MUTE button ..... (24)
- 5 FAVORITE CALL button ..... (36)
- 6 SDB TONE button ..... (24)
- 7 TOP MENU button ..... (11)
- 8 POWER button (⏻) ..... (23)
- 9 DIMMER button ..... (24)
- 10 VOLUME buttons (▲▼) ..... (23)
- 11 Information button (INFO) ..... (29)
- 12 SETUP button ..... (17)
- 13 Number buttons (0 - 9, +10) ..... (36, 48)
- 14 CLEAR button ..... (36, 48, 49)

### Buttons that work with CDs

“Buttons that work with all input sources” can also be used.

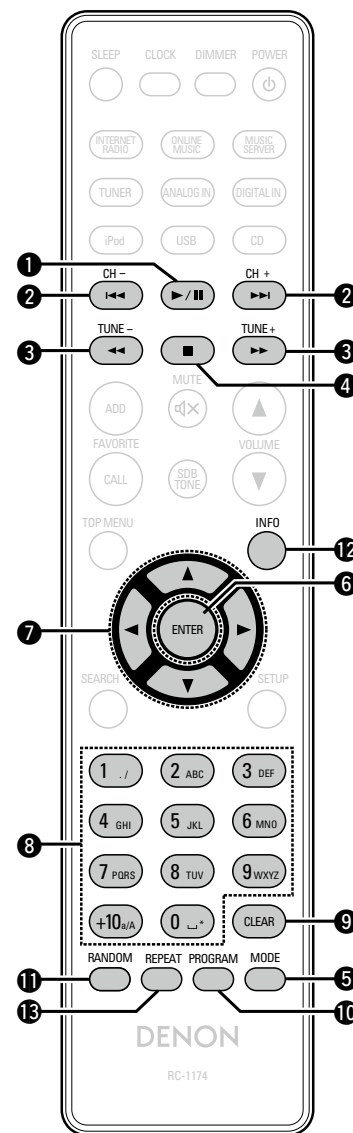

- 1 Play/Pause button (▶/⏸) ..... (25)
- 2 Reverse-skip/Forward-skip buttons (◀◀, ▶▶) ..... (25)
- 3 Fast-reverse/Fast-forward buttons (◀◀, ▶▶) ..... (25)
- 4 Stop button (■) ..... (25)
- 5 MODE button ..... (28)
- 6 ENTER button ..... (25)
- 7 Cursor buttons (▲▼◀▶) ..... (28)
- 8 Number buttons (0 - 9, +10) ..... (25)
- 9 CLEAR button ..... (27)
- 10 PROGRAM button ..... (27)
- 11 RANDOM button ..... (26)
- 12 Information button (INFO) ..... (26)
- 13 REPEAT button ..... (26)



□ Buttons that work when the input source is “Internet Radio”, “Music Server” or “Last.fm”

“Buttons that work with all input sources” can also be used.

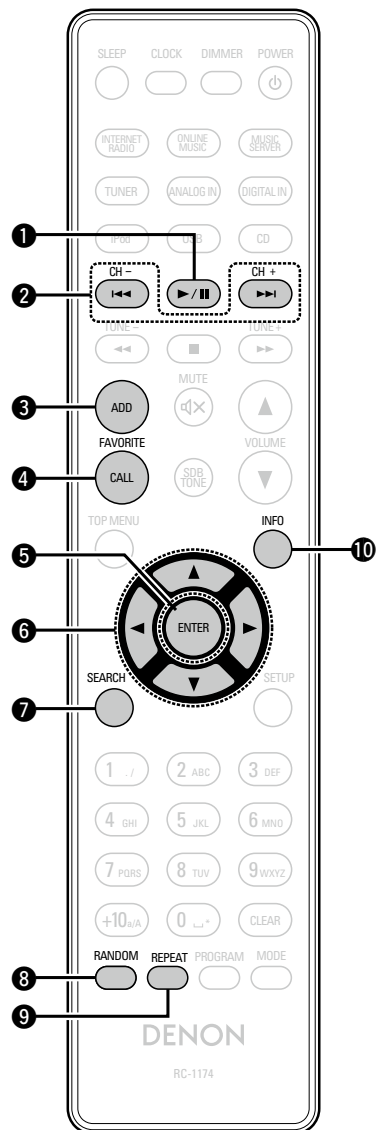

- 1 Play/Pause button (▶/⏸)..... (29)
- 2 Reverse-skip/Forward-skip buttons (I<-<, I>>I) ..... (31)
- 3 FAVORITE ADD button ..... (36)
- 4 FAVORITE CALL button ..... (36)
- 5 ENTER button ..... (29)
- 6 Cursor buttons (Δ▽◀▶)..... (29)
- 7 SEARCH button ..... (29)
- 8 RANDOM button ..... (31)
- 9 REPEAT button ..... (31)
- 10 Information button (INFO)..... (29)

□ Buttons that work when the input source is “TUNER”

“Buttons that work with all input sources” can also be used.

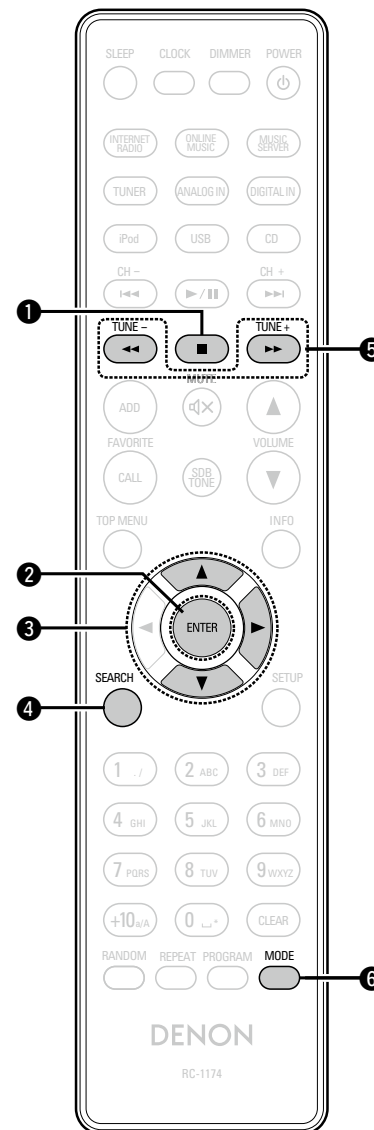

- 1 Stop button (■)..... (33)
- 2 ENTER button ..... (33)
- 3 Cursor buttons (Δ▽◀▶) ..... (33)
- 4 SEARCH button ..... (33)
- 5 Tuning up/Tuning down buttons (TUNE +, -) ..... (33)
- 6 MODE button ..... (33)

□ **Buttons that work when the input source is "iPod" or "USB"**

"Buttons that work with all input sources" can also be used.

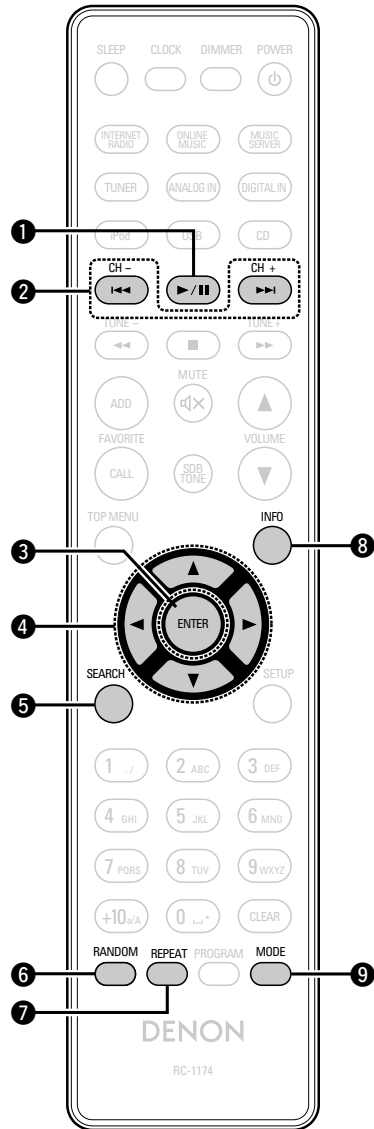

- ❶ **Play/Pause button (▶/⏸)**..... (37, 40)
- ❷ **Reverse-skip/Forward-skip buttons (◀◀, ▶▶)** ..... (37, 41)
- ❸ **ENTER button** ..... (37)
- ❹ **Cursor buttons (▲▼◀▶)**..... (37)
- ❺ **SEARCH button** ..... (41)
- ❻ **RANDOM button** ..... (37, 40)
- ❼ **REPEAT button** ..... (37, 40)
- ❽ **Information button (INFO)**..... (37, 41)
- ❾ **MODE button**..... (37)



“Made for iPod” and “Made for iPhone” mean that an electronic accessory has been designed to connect specifically to iPod, or iPhone, respectively, and has been certified by the developer to meet Apple performance standards.

Apple is not responsible for the operation of this device or its compliance with safety and regulatory standards. Please note that the use of this accessory with iPod, or iPhone, may affect wireless performance.

AirPlay, the AirPlay logo, iPhone, iPod, iPod classic, iPod nano, iPod shuffle, and iPod touch are trademarks of Apple Inc., registered in the U.S. and other countries.

- Individual users are permitted to use iPhone, iPod, iPod classic, iPod nano, iPod shuffle, and iPod touch for private copy and playback of non-copyrighted contents and contents whose copy and playback is permitted by law. Copyright infringement is prohibited by law.

## MP3 and WMA formats

CD-R and CD-RW discs created in the format described below can be played.

### Writing software format

ISO9660 level 1

When written in other formats, it may not be possible to play the disc properly.

### Maximum number of playable files and folders

Total number of folders and files : 512

Number of folders : 256

### File format

MPEG-1 Audio Layer-3

WMA (Windows Media Audio)

### Tag data

ID3-Tag (Ver. 1.x and 2.x)

META-Tag

(Compatible with title, artist and album names)

Playable MP3/WMA file			
File format	Sampling frequency	Bit rate	Extension
MP3	32, 44.1, 48 kHz	32 ~ 320 kbps	.mp3
WMA	32, 44.1, 48 kHz	64 ~ 192 kbps	.wma



- Be sure to give files the extension “.MP3” or “.WMA”. Files with any other extensions or with no extensions cannot be played.
- Mac OS X files assigned with filenames that begin with “.\_” are not music data and cannot be played back.
- In accordance with copyright laws, recordings you have made should only be used for your personal enjoyment and may not be used in other ways without permission of the copyright holder.

# USB memory device

Playing back music files recorded on a USB memory device.

## Important information

- Only USB memory devices conforming to mass storage class and MTP (Media Transfer Protocol) standards can be played on this unit.
- This unit is compatible with USB memory devices in "FAT16" or "FAT32" format.
- This unit is compatible with MP3 files conforming to "MPEG-1 Audio Layer-3" standards.
- File types that this unit can play back and specifications are shown below.

### [Supported file types]

Supported file types	USB memory devices *1
<b>WMA</b> (Windows Media Audio)	✓*2
<b>MP3</b> (MPEG-1 Audio Layer-3)	✓
<b>WAV</b>	✓
<b>MPEG-4 AAC</b>	✓*3
<b>FLAC</b> (Free Lossless Audio Codec)	✓

\*1 USB memory device

- This unit is compatible with MP3 ID3-Tag (Ver. 2) standard.
- This unit is compatible with WMA META tags.
- WAV format Quantization bit length: 16 bits.
- FLAC format Quantization bit length: 16 or 24 bits.

\*2 Copyright-protected files can be played on certain portable players compatible with MTP.

\*3 Only files that are not protected by copyright can be played on this unit.

Content downloaded from pay sites on the Internet are copyright protected. Also, files encoded in WMA format when ripped from a CD, etc. on a computer may be copyright protected, depending on the computer's settings.

### NOTE

File types that this unit does not support are not displayed.

### [Compatible formats]

	Sampling frequency	Bit rate	Bit length	Extension
<b>WMA</b> (Windows Media Audio)	32/44.1/ 48 kHz	48 – 192 kbps	–	.wma
<b>MP3</b> (MPEG-1 Audio Layer-3)	32/44.1/ 48 kHz	32 – 320 kbps	–	.mp3
<b>WAV</b>	32/44.1/ 48/88.2/ 96/176.4/ 192 kHz	–	16 / 24 bit	.wav
<b>MPEG-4 AAC</b>	32/44.1/ 48 kHz	16 – 320 kbps	–	.aac/ .m4a/ .mp4
<b>FLAC</b> (Free Lossless Audio Codec)	32/44.1/ 48/88.2/ 96/176.4/ 192 kHz	–	16 / 24 bit	.flac

### ☐ Maximum Number of Playable Files and Folder

The limits on the number of folders and files that can be displayed by this unit are as follows.

Item	Media	USB memory devices
Memory capacity		FAT16 : 2 GB, FAT32 : 2 TB
Number of folder directory levels *1		8 levels
Number of folders		500
Number of files *2		5000

\*1 The limited number includes the root folder.

\*2 The allowable number of files may differ according to the USB memory device capacity and the file size.

## Important information

### □ About the internet radio function

- Internet radio refers to radio broadcasts distributed over the Internet. Internet radio stations from around the world can be received.
- This unit is equipped with the following Internet radio functions:
  - Stations can be selected by genre and region.
  - Internet radio stations in MP3 and WMA (Windows Media Audio) format can be listened to.
- Your favorite radio stations can be registered by accessing an exclusive DENON Internet radio URL from a Web browser on a computer.
- The function is managed for individual users, so you must provide your MAC or e-mail address. Exclusive URL: <http://www.radiodenon.com>
- The radio station database service may be suspended without notice.
- This unit's Internet radio station list is created using a radio station database service (vTuner). This database service provides a list edited and created for this unit.

### □ About Music server

This function lets you play music files and playlists (m3u, wpl) stored on a computer (music server) connected to this unit via a network.

With this unit's network audio playback function, connection to the server is possible using one of the technologies below.

- Windows Media Player Network Sharing Service
- Windows Media DRM10

#### [Types of files that can be played back by each function]

	Internet radio	Music server *1
<b>WMA</b> (Windows Media Audio)	✓	✓
<b>MP3</b> (MPEG-1 Audio Layer-3)	✓	✓
<b>WAV</b>		✓
<b>MPEG-4 AAC</b>		✓*2
<b>FLAC</b> (Free Lossless Audio Codec)		✓

A server or server software compatible with distribution in the corresponding formats is required to play music files via a network.

\*1 Music server

- This unit is compatible with MP3 ID3-Tag (Ver. 2) standard.
- This unit is compatible with WMA META tags.
- If the image size (pixels) of an album artwork exceeds 500×500 (WMA/MP3/WAV/FLAC) or 349×349 (MPEG-4 AAC), then music may not be played back properly.

\*2 Only files that are not protected by copyright can be played on this unit.

Content downloaded from pay sites on the Internet are copyright protected. Also, files encoded in WMA format when ripped from a CD, etc. on a computer may be copyright protected, depending on the computer's settings.

#### [Playback file specifications]

	Sampling frequency	Bit rate	Bit length	Extension
<b>WMA</b> (Windows Media Audio)	32/44.1/48 kHz	48 – 192 kbps	–	.wma
<b>MP3</b> (MPEG-1 Audio Layer-3)	32/44.1/48 kHz	32 – 320 kbps	–	.mp3
<b>WAV</b>	32/44.1/48/88.2/96/176.4/192 kHz	–	16 / 24 bit	.wav
<b>MPEG-4 AAC</b>	32/44.1/48 kHz	16 – 320 kbps	–	.aac/ .m4a/ .mp4
<b>FLAC</b> (Free Lossless Audio Codec)	32/44.1/48/88.2/96/176.4/192 kHz	–	16 / 24 bit	.flac

#### NOTE

Particularly when you play back large music files, depending on your wireless LAN environment, the playback sound may be interrupted. In this case, make the wired LAN connection.

### □ About Last.fm

Last.fm learns what you love... and it's a great way to discover new music.

Your new DENON Network CD receiver is very clever. You can create a free Last.fm profile when you start using your DENON Network CD receiver and magically keep track of all the songs you hear.

When you sign in at [www.last.fm](http://www.last.fm), you can see your top music charts, view thousands of reviews, biographies and artwork, and get recommendations for local performances you won't want to miss.

With an affordable subscription you can enjoy an endless choice of personalised ad-free radio stations. Check out [www.last.fm/subscribe](http://www.last.fm/subscribe) today for more details.

Your subscription also gives you access to Last.fm radio on a great range of music products, including your DENON Network CD receiver. This feature is not available in all countries. Visit [www.last.fm/hardware](http://www.last.fm/hardware) to find out more.

# Explanation terms

## A

### AES (Advanced Encryption Standard)

This is a next generation standard encryption method replacing the current DES and 3DES, and because of its high security it is expected to be applied widely to wireless LANs in the future. It uses the "Rijndael" algorithm developed by two Belgian cryptographers to divide the data into blocks of fixed lengths and encrypt each block. It supports data lengths of 128, 192 and 256 bits and key lengths of 128, 192 and 256 bits as well, offering extremely high encryption security.

### AirPlay

AirPlay sends (plays) contents recorded in iTunes or on an iPhone/iPod touch to a compatible device via the network.

## B

### Bit rate

This expresses the read amount per 1 second of video/audio data recorded in a disc. A larger number means higher sound quality, but also means a larger file size.

## D

### DLNA

DLNA and DLNA CERTIFIED are trademarks and/or service marks of Digital Living Network Alliance. Some contents may not be compatible with other DLNA CERTIFIED® products.

## F

### Finalize

This is processing that enables playing back of disc of CD, which was recorded using a recorder, by other players.

### FLAC

FLAC stands for Free lossless Audio Codec, and is a lossless free audio file format. Lossless means that the audio is compressed without any loss in quality. The FLAC license is as shown below.

Copyright (C) 2000,2001,2002,2003,2004,2005,2006,2007,2008,2009 Josh Coalson

Redistribution and use in source and binary forms, with or without modification, are permitted provided that the following conditions are met:

- Redistributions of source code must retain the above copyright notice, this list of conditions and the following disclaimer.
- Redistributions in binary form must reproduce the above copyright notice, this list of conditions and the following disclaimer in the documentation and/or other materials provided with the distribution.
- Neither the name of the Xiph.org Foundation nor the names of its contributors may be used to endorse or promote products derived from this software without specific prior written permission.

THIS SOFTWARE IS PROVIDED BY THE COPYRIGHT HOLDERS AND CONTRIBUTORS "AS IS" AND ANY EXPRESS OR IMPLIED WARRANTIES, INCLUDING, BUT NOT LIMITED TO, THE IMPLIED WARRANTIES OF MERCHANTABILITY AND FITNESS FOR A PARTICULAR PURPOSE ARE DISCLAIMED. IN NO EVENT SHALL THE FOUNDATION OR CONTRIBUTORS BE LIABLE FOR ANY DIRECT, INDIRECT, INCIDENTAL, SPECIAL, EXEMPLARY, OR CONSEQUENTIAL DAMAGES (INCLUDING, BUT NOT LIMITED TO, PROCUREMENT OF SUBSTITUTE GOODS OR SERVICES; LOSS OF USE, DATA, OR PROFITS; OR BUSINESS INTERRUPTION) HOWEVER CAUSED AND ON ANY THEORY OF LIABILITY, WHETHER IN CONTRACT, STRICT LIABILITY, OR TORT (INCLUDING NEGLIGENCE OR OTHERWISE) ARISING IN ANY WAY OUT OF THE USE OF THIS SOFTWARE, EVEN IF ADVISED OF THE POSSIBILITY OF SUCH DAMAGE.

## I

### IEEE 802.11b

This is one wireless LAN standard set by the 802 working group that establishes LAN technology standards at the IEEE (Institute of Electrical and Electronics Engineers) of the United States. It uses the 2.4 GHz band usable freely without a radio frequency license (ISM band), enabling communications at a maximum speed of 11 Mbps.

- The value indicated above is the maximum theoretical value for the wireless LAN standard, and does not indicate the actual data transfer rate.

### IEEE 802.11g

This is another wireless LAN standard set by the 802 working group that establishes LAN technology standards at the IEEE (Institute of Electrical and Electronics Engineers) of the United States, and is compatible with IEEE 802.11b. It also uses the 2.4 GHz band, but enables communications at a maximum speed of 54 Mbps.

- The value indicated above is the maximum theoretical value for the wireless LAN standard, and does not indicate the actual data transfer rate.

### iTunes

iTunes is the name of the multimedia player provided by Apple Inc. It enables management and playback of multimedia contents including music and movies. iTunes supports many main file formats including AAC, WAV, and MP3.

## M

### MP3 (MPEG Audio Layer-3)

This is an internationally standardized audio data compression scheme, using the "MPEG-1" video compression standard. It compresses the data volume to about one eleventh its original size while maintaining sound quality equivalent to a music CD.

### MPEG (Moving Picture Experts Group), MPEG-2, MPEG-4

These are the names for digital compression format standards used for the encoding of video and audio. Video standards include "MPEG-1 Video", "MPEG-2 Video", "MPEG-4 Visual", "MPEG-4 AVC". Audio standards include "MPEG-1 Audio", "MPEG-2 Audio", "MPEG-4 AAC".

## N

### Network Names

#### (SSID: Security Set Identifier)

When forming wireless LAN networks, groups are formed to prevent interference, data theft, etc. This grouping is done by "SSID" or "Security Set Identifiers". For further security, a WEP key is set and signal transfer is not possible unless the SSID and WEP key match.

## P

### Protection circuit

This is a function to prevent damage to components within the power supply when an abnormality such as an overload, excess voltage occurs or temperature for any reason.

In this unit, the power indicator blinks and the unit enters standby mode when an abnormality occurs.

## S

### Sampling frequency

Sampling involves taking a reading of a sound wave (analog signal) at regular intervals and expressing the height of the wave at each reading in digitized format (producing a digital signal).

The number of readings taken in one second is called the "sampling frequency". The larger the value, the closer the reproduced sound is to the original.

### Speaker impedance

This is an AC resistance value, indicated in  $\Omega$  (ohms). Greater power can be obtained with this value smaller.

## T

### TKIP (Temporal Key Integrity Protocol)

This is a network key used for WPA. The encryption algorithm is RC4, the same as for WEP, but the security level is increased by changing the network key used for encryption for each packet.

## V

### **vTuner**

This is a free online content server for Internet radio. Note that usage fees are included in upgrade costs.

For inquiries about this service, visit the vTuner site below.

vTuner website: <http://www.radiodemon.com>

This product is protected by certain intellectual property rights of Nothing Else Matters Software and BridgeCo. Use or distribution of such technology outside of this product is prohibited without a license from Nothing Else Matters Software and BridgeCo or an authorized subsidiary.

## W

### **WEP Key (Network Key)**

This is key information used for encrypting data when conducting data transfer. On this unit, the same WEP key is used for data encryption and decryption, so the same WEP key must be set on both devices in order for communications to be established between them.

### **Wi-Fi®**

Wi-Fi Certification assures tested and proven interoperability by the Wi-Fi Alliance, a group certifying interoperability among wireless LAN devices.

### **Windows Media DRM**

This is a copyright protection technology developed by Microsoft.

Content providers are using the digital rights management technology for Windows Media contained in this device (WM-DRM) to protect the integrity of their content (Secure Content) so that their intellectual property, including copyright, in such content is not misappropriated. This device uses WM-DRM software to play Secure Content (WM-DRM Software). If the security of the WM-DRM Software in this device has been compromised, owners of Secure Content (Secure Content Owners) may request that Microsoft revoke the WM-DRM Software's right to acquire new licenses to copy, display and/or play Secure Content. Revocation does not alter the WM-DRM Software's ability to play unprotected content.

A list of revoked WM-DRM Software is sent to your device whenever you download a license for Secure Content from the Internet or from a PC.

Microsoft may, in conjunction with such license, also download revocation list onto your device on behalf of Secure Content Owners.

### **Windows Media Player Ver. 11 or later**

This is a media player distributed free of charge by Microsoft Corporation.

It can be used to play playlists created with Windows Media Player Ver. 11 or later as well as files in such formats as WMA, DRM WMA, MP3 and WAV.

### **WMA (Windows Media Audio)**

This is audio compression technology developed by Microsoft Corporation.

WMA data can be encoded using Windows Media® Player Ver.7, 7.1, Windows Media® Player for Windows® XP and Windows Media® Player 9 Series.

To encode WMA files, only use applications authorized by Microsoft Corporation. If you use an unauthorized application, the file may not work properly.

### **WPA (Wi-Fi Protected Access)**

This is a security standard established by the Wi-Fi Alliance. In addition to the conventional SSID (network name) and WEP key (network key), it also uses a user identification function and encrypting protocol for stronger security.

### **WPA2 (Wi-Fi Protected Access 2)**

This is a new version of the WPA established by the Wi-Fi Alliance, compatible with more secure AES encryption.

### **WPA-PSK/WPA2-PSK (Pre-shared Key)**

This is a simple authentication system for mutual authentication when a preset character string matches on the wireless LAN access point and client.

### **WPS (Wi-Fi Protected Setup)**

This is a standard drawn up by the Wi-Fi Alliance to ease the task of setting up wireless LAN connections and configuring security.

There are two methods: push-button and PIN (Personal Identification Number) code.

# Troubleshooting

If a problem occurs first check the following:

1. Are the connections correct?
2. Is the set being operated as described in the owner's manual?
3. Are the other devices operating properly?

If this unit does not operate properly, check the items listed in the table below. If the problem persists, there may be a malfunction.

In this case, disconnect the power immediately and contact your retail outlet.

## [General]

Symptom	Cause	Countermeasure	Page
Set does not operate properly.	<ul style="list-style-type: none"> <li>External noise or interference is causing the set to malfunction.</li> </ul>	<ul style="list-style-type: none"> <li>Reset the microprocessor.</li> </ul>	<a href="#">49</a>
Display not lit and sound not produced when power switched to on.	<ul style="list-style-type: none"> <li>Power cord not plugged in securely.</li> </ul>	<ul style="list-style-type: none"> <li>Check the connections on the set's rear panel and the connection of the power plug to the power outlet.</li> </ul>	<a href="#">10</a>
Display lit but sound not produced.	<ul style="list-style-type: none"> <li>The speaker cables are not properly connected.</li> <li>The function is not switched to the input source you want to play.</li> <li>The volume is set too low.</li> </ul>	<ul style="list-style-type: none"> <li>Connect securely.</li> </ul>	<a href="#">6</a>
		<ul style="list-style-type: none"> <li>Switch to the correct function.</li> </ul>	<a href="#">23</a>
		<ul style="list-style-type: none"> <li>Adjust the volume to an appropriate level.</li> </ul>	<a href="#">23</a>
Display is off.	<ul style="list-style-type: none"> <li>The Dimmer setting is set to "Off".</li> </ul>	<ul style="list-style-type: none"> <li>Set to something other than "Off".</li> </ul>	<a href="#">24</a>
For stereo sources, the positions of the instruments are inverted.	<ul style="list-style-type: none"> <li>The connections of the speaker cables or input cables are inverted.</li> </ul>	<ul style="list-style-type: none"> <li>Check and remedy the connections.</li> </ul>	<a href="#">6</a> – <a href="#">10</a>
Power turns off suddenly and POWER indicator flashes red. (Flashes at 0.25 second intervals)	<ul style="list-style-type: none"> <li>Set is damaged.</li> </ul>	<ul style="list-style-type: none"> <li>Turn off the power and contact a DENON service center.</li> </ul>	–
"No Network Connection" is displayed.	<ul style="list-style-type: none"> <li>The network is not properly set up.</li> </ul>	<ul style="list-style-type: none"> <li>Select a source other than the network function.</li> <li>Perform "Quick Setup".</li> </ul>	<a href="#">23</a> Quick setup guide

## [CD]

Symptom	Cause	Countermeasure	Page
"Unsupported" is shown on the display even though a CD is loaded.	<ul style="list-style-type: none"> <li>The disc is not properly loaded.</li> </ul>	<ul style="list-style-type: none"> <li>Reload the disc.</li> </ul>	<a href="#">3</a>
Disc does not play when ►/   button is pressed.	<ul style="list-style-type: none"> <li>The disc is dirty or scratched.</li> </ul>	<ul style="list-style-type: none"> <li>Wipe the disc clean or replace the disc.</li> </ul>	<a href="#">3</a>
A specific part of a disc is not played.	<ul style="list-style-type: none"> <li>The disc is dirty or scratched.</li> </ul>	<ul style="list-style-type: none"> <li>Wipe the disc clean or replace the disc.</li> </ul>	<a href="#">3</a>
A CD-R or CD-RW disc cannot be played.	<ul style="list-style-type: none"> <li>The disc has not been finalized.</li> <li>The recording conditions are bad or the quality of the disc itself is poor.</li> </ul>	<ul style="list-style-type: none"> <li>Finalize the disc then play it.</li> <li>Use a properly recorded disc.</li> </ul>	<a href="#">3</a> –
MP3 and WMA files cannot be played.	<ul style="list-style-type: none"> <li>The file formats, extensions or settings made when the disc was created are not compatible with this unit.</li> </ul>	<ul style="list-style-type: none"> <li>Create discs with file formats, extensions or settings compatible with this unit.</li> </ul>	<a href="#">56</a>

## [Tuner]

Symptom	Cause	Countermeasure	Page
Continuous noise is heard when receiving FM programs.	<ul style="list-style-type: none"> <li>Antenna cable is not properly connected.</li> </ul>	<ul style="list-style-type: none"> <li>Connect the antenna cable properly.</li> <li>Connect an outdoor antenna.</li> </ul>	<a href="#">8</a> –



**[Internet radio/Music server/iPod/USB memory device]**

Symptom	Cause	Countermeasure	Page
When a USB memory device is connected, "USB" is not displayed.	• The set cannot recognize a USB memory device.	• Check the connection.	<a href="#">40</a>
	• A USB memory device not conforming to mass storage class or MTP standards is connected.	• Connect a USB memory device conforming to mass storage class or MTP standards.	–
	• A USB memory device that the set cannot recognize is connected.	• This is not a malfunction. DENON does not guarantee that all USB memory devices will operate or receive power.	–
iPod cannot be played.	• USB memory device is connected via USB hub.	• Connect the USB memory device directly to the USB port.	–
	• The input source is set to something other than "iPod".	• Switch the input source to "iPod".	<a href="#">23</a>
Files on a USB memory device cannot be played.	• Cable is not properly connected.	• Reconnect.	<a href="#">37</a>
	• USB memory device is in a format other than FAT16 or FAT32.	• Set the format to FAT16 or FAT32. For details, refer to the USB memory device's operating instructions.	–
	• USB memory device is divided into multiple partitions.	• When divided into multiple partitions, only files stored in the top partition can be played.	–
Internet radio cannot be played.	• Files are stored in a non-compatible format.	• Record the files in a compatible format.	<a href="#">57</a>
	• You are attempting to play a file that is copyright protected.	• Files that are copyright protected cannot be played on this set.	<a href="#">57</a>
Internet radio cannot be played.	• Ethernet cable is not properly connected or network is disconnected.	• Check the connection status.	<a href="#">9</a>
	• Program is being broadcast in non-compatible format.	• Only Internet radio programs in MP3 and WMA can be played on this set.	<a href="#">58</a>
	• The computer's or router's firewall is activated.	• Check the computer's or router's firewall settings.	–
	• Radio station is not currently broadcasting.	• Choose a radio station that is currently broadcasting.	<a href="#">29</a>
Internet radio cannot be played.	• IP address is wrong.	• Check the set's IP address.	<a href="#">17</a>

Symptom	Cause	Countermeasure	Page
Files stored on a computer cannot be played.	• Files are stored in a non-compatible format.	• Record in a compatible format.	<a href="#">58</a>
	• You are attempting to play a file that is copyright protected.	• Files that are copyright protected cannot be played on this set.	<a href="#">58</a>
Server is not found, or it is not possible to connect to the server.	• Set and computer are connected by USB cable.	• The set's USB port cannot be used for connection to a computer.	–
	• The computer's or router's firewall is activated.	• Check the computer's or router's firewall settings.	–
Cannot connect to favorite radio stations.	• Computer's power is not turned on.	• Turn on the power.	–
	• Server is not running.	• Launch the server.	–
For some radio stations, "Server Full" or "Connection Down" is displayed and station cannot be connected to.	• Set's IP address is wrong.	• Check the set's IP address.	<a href="#">17</a>
	• Radio station is not currently broadcasting.	• Wait a while before trying again.	–
Sound is broken during playback.	• Radio station is not currently in service.	• It is not possible to connect to radio stations that are no longer in service.	–
	• Station is congested or not currently broadcasting.	• Wait a while before trying again.	–
Sound quality is poor or played sound is noisy.	• Network's signal transfer speed is slow or communications lines or radio station is congested.	• This is not a malfunction. When playing broadcast data with a high bit rate, the sound may be broken, depending on the communications conditions.	–
	• File being played has a low bit rate.	• This is not a malfunction.	–



## [Last.fm]

Symptom	Cause	Countermeasure	Page
Cannot login to Last.fm. ("Subscription required" is displayed.)	<ul style="list-style-type: none"> <li>Login authentication error.</li> <li>If a nonsubscriber user accesses it. Or when the listening limitation exceeds it.</li> </ul>	<ul style="list-style-type: none"> <li>Enter the correct username and password and retry login.</li> <li>You need to be a paid Last.fm subscriber to listen to this. Visit <a href="http://www.last.fm/subscribe">www.last.fm/subscribe</a> to upgrade.</li> </ul>	–
Cannot play back music. ("Library empty" is displayed.)	<ul style="list-style-type: none"> <li>No music data to be played back.</li> </ul>	<ul style="list-style-type: none"> <li>Visit <a href="http://www.last.fm/download">www.last.fm/download</a> and install the Scrobbler to add the music you've played to your profile and make this feature work.</li> </ul>	–
Cannot play back music. ("No more tracks" is displayed.)	<ul style="list-style-type: none"> <li>When you played all tunes of the playlist.</li> </ul>	<ul style="list-style-type: none"> <li>Select another playlist.</li> </ul>	–
Cannot access the Last.fm. ("No network Connection" is displayed.)	<ul style="list-style-type: none"> <li>Cannot connect to the network.</li> </ul>	<ul style="list-style-type: none"> <li>Check the network environment.</li> </ul>	<a href="#">9</a>
Cannot access the Last.fm. ("Not available in your country" is displayed.)	<ul style="list-style-type: none"> <li>You are accessing the network from a country where Last.fm radio is not available.</li> </ul>	<ul style="list-style-type: none"> <li>Last.fm radio is not available in all countries. Please check <a href="http://www.last.fm/hardware">www.last.fm/hardware</a> for more information.</li> </ul>	–
Cannot login to Last.fm. ("Incorrect user or password" is displayed.)	<ul style="list-style-type: none"> <li>Incorrect username or password entered for login authentication.</li> </ul>	<ul style="list-style-type: none"> <li>Enter the correct username and password and retry login.</li> </ul>	–
Cannot create and register an account. ("Try another username" is displayed.)	<ul style="list-style-type: none"> <li>The username has already been taken.</li> </ul>	<ul style="list-style-type: none"> <li>Enter another username to create and register the account.</li> </ul>	–

## [Wireless LAN]

Symptom	Cause	Countermeasure	Page
Cannot connect to network.	<ul style="list-style-type: none"> <li>The settings of the SSID and network key (WEP) are incorrect.</li> <li>The reception is poor and the signals cannot be received.</li> <li>There are multiple networks and the usable channels overlap.</li> <li>The router power is off.</li> </ul>	<ul style="list-style-type: none"> <li>Match the network settings with this unit settings.</li> <li>Shorten the distance from the wireless LAN's access point, remove any obstacles and otherwise improve visibility, then try reconnecting. Also install away from microwave ovens and the access points of other networks.</li> <li>Set the access point's channel settings away from the channels used for other networks. Alternatively, connect using a network cable.</li> <li>Turn on the router power.</li> </ul>	<a href="#">20</a> – – –
Cannot achieve network connection using the <b>WPS</b> button.	<ul style="list-style-type: none"> <li>The encryption type on the router is set to "WEP" or "TKIP".</li> </ul>	<ul style="list-style-type: none"> <li>Set the encryption type to "None", "WPA-PSK(AES)" or "WPA2-PSK(AES)" before establishing connection.</li> </ul>	<a href="#">18, 19</a>
Played sound is interrupted or sound cannot be played.	<ul style="list-style-type: none"> <li>There are multiple networks and the usable channels overlap.</li> </ul>	<ul style="list-style-type: none"> <li>Set the access point's channel settings away from the channels used for other networks. Alternatively, connect using a network cable.</li> </ul>	–

**[AirPlay]**

Symptom	Cause	Countermeasure	Page
The AirPlay icon  is not displayed in iTunes or on the iPhone/iPod touch.	<ul style="list-style-type: none"><li>• This unit and the computer or iPhone/iPod touch are not connected to the same network (LAN).</li><li>• iTunes or the iPhone/iPod touch do not have firmware that supports AirPlay installed.</li></ul>	<ul style="list-style-type: none"><li>• Connect the computer or iPhone/iPod touch to the same network as this unit.</li><li>• Update to the latest firmware.</li></ul>	<a href="#">9</a> <a href="#">14</a>
No sound.	<ul style="list-style-type: none"><li>• This unit is not selected in the screen that is displayed when iTunes or the iPhone/iPod touch is started.</li></ul>	<ul style="list-style-type: none"><li>• Start iTunes or switch on the iPhone/iPod touch, click the AirPlay icon  in the displayed screen, and select this unit.</li></ul>	<a href="#">43</a>

**[Remote control]**

Symptom	Cause	Countermeasure	Page
Set does not work properly when remote control operated.	<ul style="list-style-type: none"><li>• Batteries are worn.</li></ul>	<ul style="list-style-type: none"><li>• Replace with new batteries.</li></ul>	<a href="#">4</a>
	<ul style="list-style-type: none"><li>• You are operating outside of the specified range.</li></ul>	<ul style="list-style-type: none"><li>• Operate within the specified range.</li></ul>	<a href="#">4</a>
	<ul style="list-style-type: none"><li>• Obstacle between main unit and remote control.</li></ul>	<ul style="list-style-type: none"><li>• Remove the obstacle.</li></ul>	–
	<ul style="list-style-type: none"><li>• The batteries are not inserted in the proper direction, as indicated by the polarity marks in the battery compartment.</li></ul>	<ul style="list-style-type: none"><li>• Insert the batteries in the proper direction, following the polarity marks in the battery compartment.</li></ul>	<a href="#">4</a>
	<ul style="list-style-type: none"><li>• The set's remote control sensor is exposed to strong light (direct sunlight, fluorescent light, etc.).</li></ul>	<ul style="list-style-type: none"><li>• Move the set to a place in which the remote control sensor will not be exposed to strong light.</li></ul>	<a href="#">4</a>

# Specifications

## CD player

<b>Playback frequency response:</b>	10 Hz – 20 kHz
<b>Wow &amp; flutter:</b>	Below measurable limits ( $\pm 0.001\%$ )
<b>Sampling frequency:</b>	44.1 kHz

## Audio AMP

<b>Rated output:</b>	2-channel driving 65 W + 65 W (4 $\Omega$ , 1 kHz, T.H.D. 0.7 %)
<b>Dynamic power:</b>	80 W + 80 W (4 $\Omega$ )
<b>Output terminals:</b>	Speaker 4 – 16 $\Omega$ Suited for headphones/stereo headphones
<b>Input sensitivity/impedance:</b>	AUX: 200 mV/22 k $\Omega$
<b>Total harmonic distortion (1 kHz, 5 W, 8 <math>\Omega</math>):</b>	AUX: 0.05 %
<b>S/N ratio (10 W, 8 <math>\Omega</math>, IHF-A):</b>	AUX: 86 dB
<b>Tone control:</b>	SDB : 100 Hz +8 dB BASS : 100 Hz $\pm$ 10 dB TREBLE : 10 kHz $\pm$ 10 dB
<b>Frequency response:</b>	10 Hz – 40 kHz (+0.5 dB, –3 dB) (SOURCE DIRECT: ON)

## Tuner

<b>Reception frequency range:</b>	FM : 87.50 MHz – 108.00 MHz
<b>Reception sensitivity:</b>	FM : 1.2 $\mu$ V / 75 $\Omega$
<b>FM channel separation:</b>	30 dB (1 kHz)
<b>FM S/N ratio:</b>	Monaural : 74 dB      Stereo : 70 dB
<b>FM harmonic distortion:</b>	Monaural : 0.3 %      Stereo : 0.4 %

## Wireless LAN

<b>Network type (wireless LAN standards):</b>	Conforming to IEEE 802.11b Conforming to IEEE 802.11g (Conforming to Wi-Fi®)*
<b>Transfer rate:</b>	DS-SS: 11 / 5.5 / 1 Mbps (Automatic switching) OFDM: 54 / 48 / 36 / 24 / 18 / 12 / 9 / 6 Mbps (Automatic switching)
<b>Security:</b>	SSID (Network name) WEP key (network key) (64/128 bits) WPA-PSK (TKIP/AES) WPA2-PSK (TKIP/AES)
<b>Used frequency range:</b>	2.412 MHz – 2.472 MHz
<b>No. of channels:</b>	Conforming to IEEE 802.11b : 13ch (DS-SS) (Of which 1 channel used) Conforming to IEEE 802.11g : 13ch (OFDM) (Of which 1 channel used)

## Clock/Alarm

<b>Clock type:</b>	Power line frequency synchronized method (Within $\pm 60$ seconds per month)
<b>Alarm:</b>	Everyday alarm / Once alarm : One system each Sleep timer : Max. 90 minutes

## Power supply

<b>Power supply voltage/frequency:</b>	AC 230 V, 50/60 Hz
<b>Power consumption:</b>	55 W
<b>Power consumption in standby mode:</b>	0.3 W
<b>Power consumption in "Network Control" – "On" mode:</b>	3 W

- \* Wi-Fi® conformity indicates tested and proven interoperability by the "Wi-Fi Alliance", a group certifying interoperability among wireless LAN devices.
- For purposes of improvement, specifications and design are subject to change without notice.

## Index

### A

Accessories	2
Add New Feature	16
AES	20, 59
AirPlay	43, 45, 59
Auto preset	33
Auto-Standby	14

### B

Bit rate	56, 58, 59
Browse mode	38

### C

Cable	
Audio cable	6
Ethernet cable	9
Optical cable	6
Speaker cable	6
Stereo mini-plug cable	6
Subwoofer cable	6
Characters	19, 20, 45, 48, 49
Connection	
Antenna	8
Network	9
Portable audio player	7
Power cord	10
Speaker	6
Current time	13

### D

Display's brightness	24
DLNA	59

### F

Favorite list	36
Finalize	3, 59
Firmware Update	14
FLAC	59
FM indoor antenna	8
Friendly Name	21
Front panel	51

### H

Headphones	24
------------	----

### I

IEEE 802.11b	59
IEEE 802.11g	59
Input source	23
Inputting characters	45, 48
Internet radio	29
iTunes	43, 45, 59

### L

Last.fm	32
Last.fm Display	20

### M

Menu map	11
MP3	28, 57, 58, 59
MPEG	59
MPEG-4 AAC	57
Music server	31

### N

Network Control	20
Network Names (SSID)	59

### P

Playback	
ANALOG IN	41
CD	25
DIGITAL IN	42
Files	28
FM	33
Internet radio	29
iPod	37
Last.fm	32
Music server	31
Network audio	29, 58
Portable audio player	41
Program	27
Random	26, 40
Repeat	26, 40
USB memory device	40
Protection circuit	59
PTY	34

### R

RDS	34
Rear panel	52
Remote control	4, 53, 54, 55
Battery	4
Remote mode	38
Resetting the microprocessor	49
RT	35

### S

Sampling frequency	56, 58, 59
Setting	
General	12
Network	12, 17, 18, 20
Sleep timer	24
Speaker impedance	59
Subwoofer	6

### T

TKIP	59
TP	34

### U

Update Notification	15
Upgrade Notification	16

### V

vTuner	58, 60
--------	--------

### W

Web control	46
WEP Key	20, 60
Wi-Fi	60
Windows Media DRM	58, 60
Windows Media Player	30, 60
WMA	28, 57, 58, 60
WPA	20, 60
WPA2	20, 60
WPA-PSK/WPA2-PSK	60
WPS	19, 20, 60

## Dimensions

Unit : mm

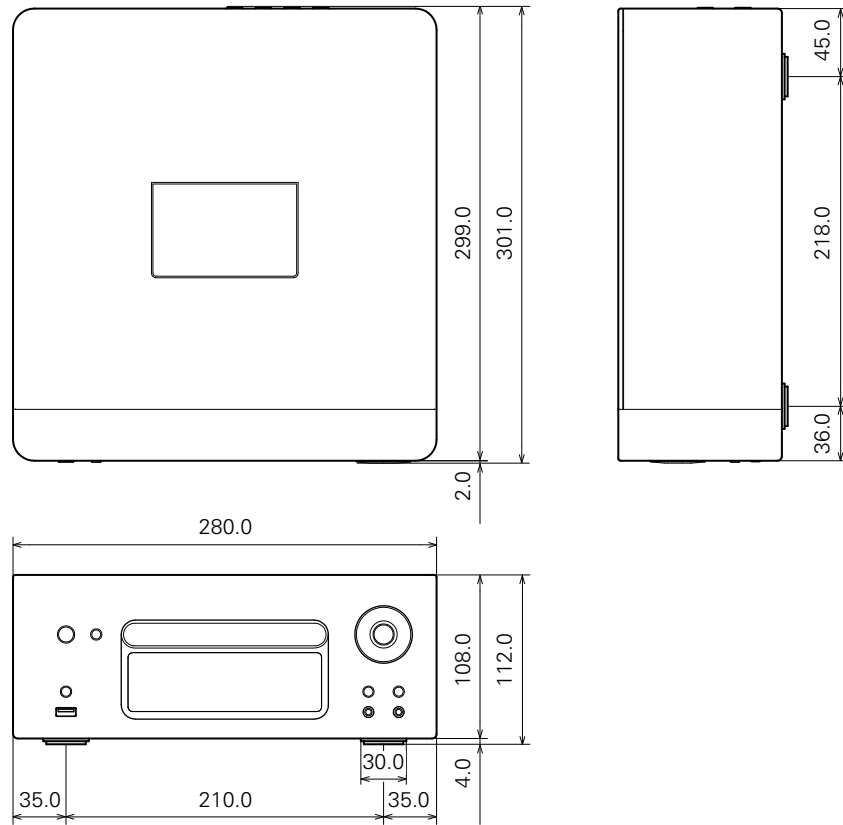

Weight : 4.0 kg

