

# DENON<sup>®</sup>

## DCD-100

COMPACT DISC PLAYER

# Owner's Manual

[Front panel](#)[Display](#)[Rear panel](#)[Remote](#)[Index](#)

<b>Accessories</b>	<b>4</b>
Inserting the batteries	5
Operating range of the remote control unit	5
<b>Features</b>	<b>6</b>
High quality	6
High performance	6
<b>Part names and functions</b>	<b>7</b>
Front panel	7
Display	9
Rear panel	10
Remote control unit	11

## Connections

<b>Connecting a digital device</b>	<b>16</b>
<b>Connecting an analog device</b>	<b>17</b>
<b>Connecting the power cord</b>	<b>18</b>

## Playback

<b>Basic operation</b>	<b>20</b>
Turning the power on	20
Switching the power to standby	20
Switching the display's brightness	21
<b>Playing CDs</b>	<b>22</b>
Playing CDs	22
Playing tracks in a specific order (Program playback)	24
<b>Playing DATA CDs (MP3 and WMA files)</b>	<b>25</b>
Playing files	26

## Settings

Auto Standby	28
Auto Play	29
Sleep timer function	29



## Tips

Tips	31
Troubleshooting	32

## Appendix





<b>Playable media</b>	<b>36</b>
Discs	36
Files	36
Playback order of music files	37
About discs and files	38
<b>Cautions on using media</b>	<b>39</b>
Loading Discs	39
Cautions on Loading Discs	39
How to handle media	40
Cleaning discs	40
<b>Explanation of terms</b>	<b>41</b>
<b>Specifications</b>	<b>42</b>
<b>Index</b>	<b>45</b>



Thank you for purchasing this Denon product. To ensure proper operation, please read this owner's manual carefully before using the product. After reading this manual, be sure to keep it for future reference.

## Accessories

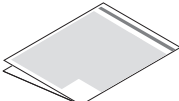
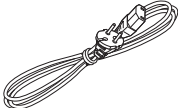
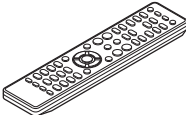
Check that the following parts are supplied with the product.

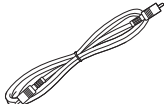
 Quick Start Guide	 Safety Instructions	 Cautions on Using Batteries	 Power cord
 Remote control unit (RC-1215)	 R03/AAA batteries	 Coaxial digital cable	



## Inserting the batteries

- 1 Remove the rear lid in the direction of the arrow and remove it.



- 2 Insert two batteries correctly into the battery compartment as indicated.

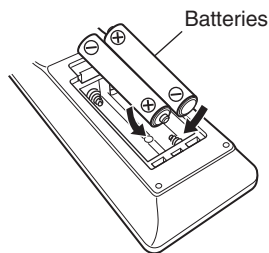

- 3 Put the rear cover back on.

### NOTE

- To prevent damage or leakage of battery fluid:
  - Do not use a new battery together with an old one.
  - Do not use two different types of batteries.
- Remove the batteries from the remote control unit if it will not be in use for long periods.
- If the battery fluid should leak, carefully wipe the fluid off the inside of the battery compartment and insert new batteries.

## Operating range of the remote control unit

Point the remote control unit at the remote sensor when operating it.

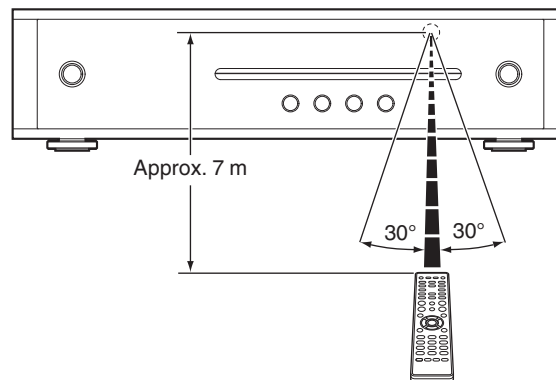

## Features

### High quality

- **A new style of CD player with Denon's trademark quality, containing a high-precision 32-bit D/A converter**

The D/A converter is a key element of sound quality, so this product contains our 32 bit/384 kHz D/A converter, renowned for its high degree of precision, to bring you the best sound quality possible.

- **This unit can be combined with the DRA-100, a network receiver with a high-quality class-D amplifier, to achieve high-quality reproduction of even the finest signals.**

In addition to a high-quality class-D amplifier, the DRA-100 network receiver contains Advanced AL32 Processing, a unique analog waveform recreation technology from Denon. Combine it with this unit to enjoy sound with an intricacy and power far greater than you'd expect from a device of its size.

### High performance

- **This new design is the optimal match for our DRA-100 network receiver**
- **Slot-in CD mechanism with smooth and steady operation.**
- **Supports MP3 and WMA file playback**  
This unit can play back MP3 and WMA files recorded on CD-R and CD-RW discs.  
The high-visibility organic EL display can show information such as the track name and artist name when playing back MP3s and WMAs.
- **The auto standby function reduces power consumption**
- **This unit comes with a system remote control that can also operate the DRA-100**



## Part names and functions

### Front panel

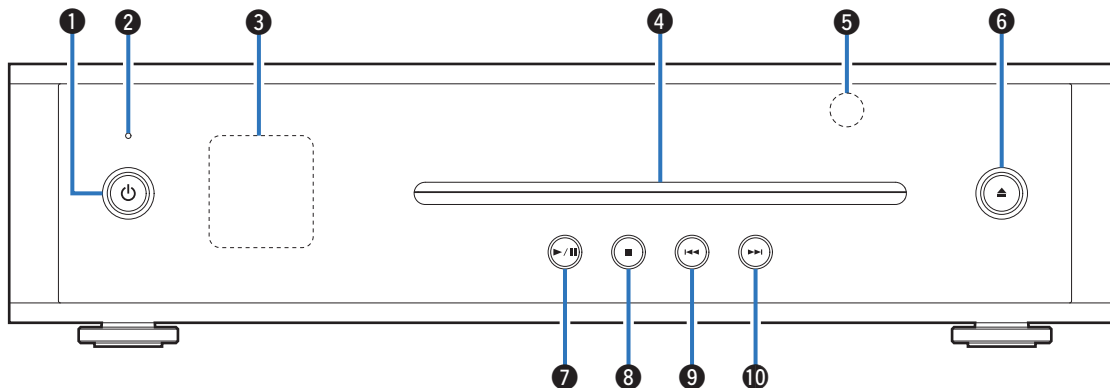

For details, see the next page.



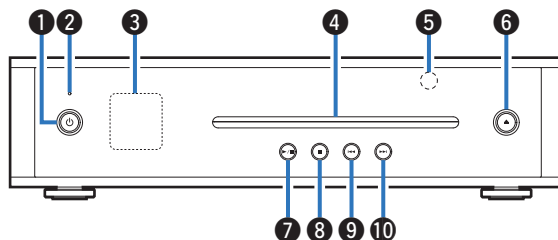

### 1 Power operation button (⏻)

This turns the power on/to standby. (👉 p. 20)

The power status is indicated as follows.

- Power on: Display lit
- Standby: Display off

### 2 Protection circuit indicator

This blinks when the protection circuit has operated. (👉 p. 32)

### 3 Display

This displays various pieces of information. (👉 p. 9)

### 4 CD slot (👉 p. 39)

### 5 Remote control sensor

This receives signals from the remote control unit. (👉 p. 5)

### 6 CD Eject button (⏏)

Ejects the disc.

### 7 Play/pause button (▶ / ⏸)

Plays the track/Pauses the track.

### 8 Stop button (■)

Stops playback.

### 9 Reverse-skip button (⏮)

Returns to the start of the currently playing track.

### 10 Forward-skip button (⏭)

Plays the next track.





## Display

### Display sample

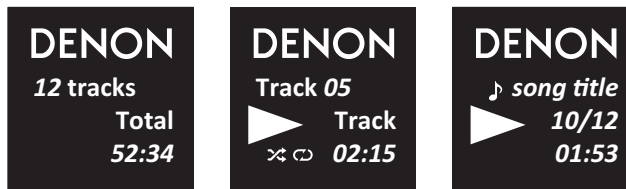

### Description of icon

- ⌘: random
- ↺: repeat all
- ↺ 1: repeat 1
- 🎵: track
- : folder



## Rear panel

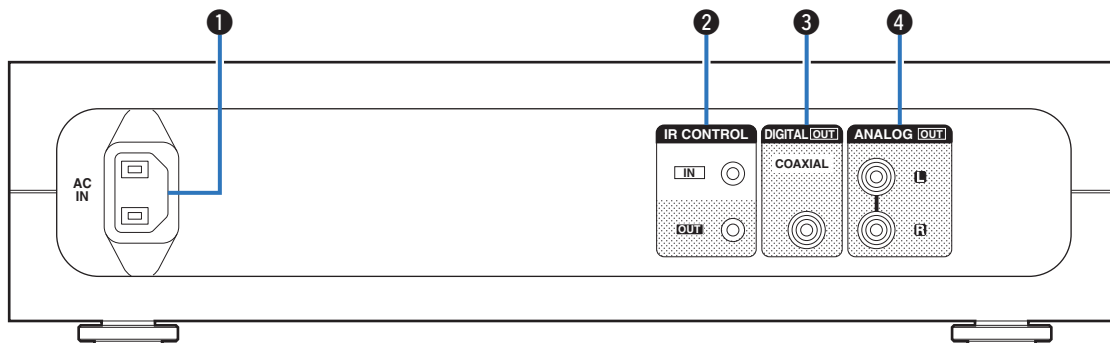

**1 AC inlet (AC IN)**

Used to connect the supplied power cord. (☞ p. 18)

**2 IR CONTROL connectors**

Used to connect Denon network audio players with an IR controller.

**3 DIGITAL OUT connector (COAXIAL)**

Used to connect an amplifier equipped with digital audio input connector. (☞ p. 16)

**4 ANALOG OUT connectors**

Used to connect an amplifier equipped with analog audio input connectors. (☞ p. 17)

## Remote control unit

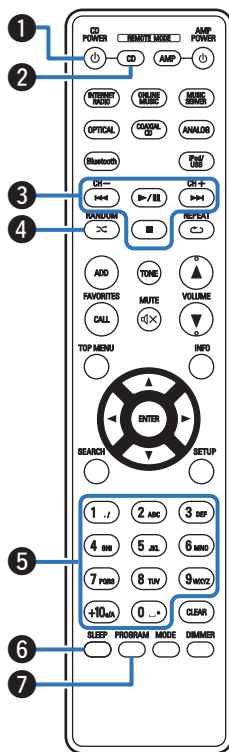

### ■ Operating this unit

To operate CD player, press REMOTE MODE CD button to switch the remote control to the CD operation mode.

- REMOTE MODE CD button lights for approximately two seconds.

#### 1 Power operation button (CD POWER $\text{\textcircled{P}}$ )

This turns the power on/to standby.

#### 2 Remote mode select button (REMOTE MODE CD)

This switches the remote control operating mode to CD.

#### 3 System buttons

These perform playback related operations.

#### 4 RANDOM button ( $\text{\textcircled{R}}$ )

Switches the random playback.

#### 5 Number buttons (0 – 9, +10)

These enter numbers into the unit.

#### 6 SLEEP button

This sets the sleep timer. (👉 p. 29)

#### 7 PROGRAM button

This sets program playback. (👉 p. 24)

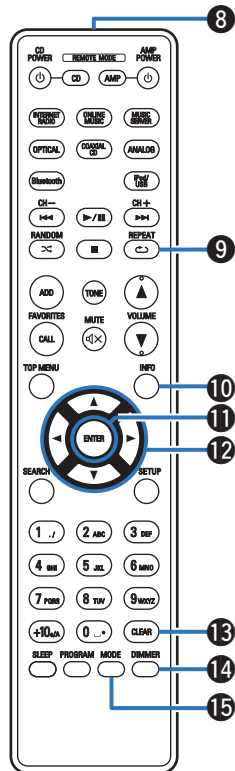

**8 Signal transmitter**

This transmits signals from the remote control unit. (☞ p. 5)

**9 REPEAT button** (↺)

Switches the repeat playback.

**10 INFO button**

This switches the track information shown in the display during playback.

**11 ENTER button**

This determines the selection.

**12 Cursor buttons** (Δ▽◀▶)

These select folders or files on a data CD.

**13 CLEAR button**

This clears the program registration.

**14 DIMMER button**

Adjust the display brightness of this unit. (☞ p. 21)

**15 MODE button**

This switches the playback mode. (☞ p. 25)



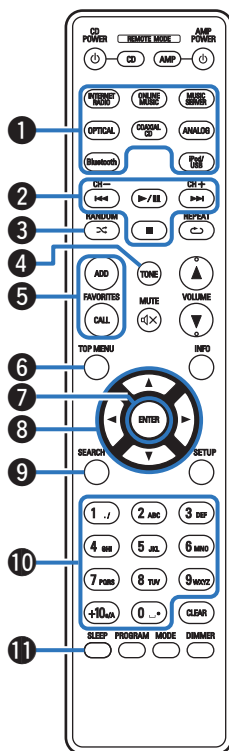

## ■ Network receiver operations

To operate a Denon network receiver, press the REMOTE MODE AMP button to switch the remote control to the network receiver operation mode.

- REMOTE MODE AMP button lights for approximately two seconds.

- 1 Input source select buttons
- 2 System buttons  
Channel buttons (CH +, -)
- 3 RANDOM button (⌘)
- 4 TONE button
- 5 FAVORITES ADD / CALL buttons
- 6 TOP MENU button
- 7 ENTER button
- 8 Cursor buttons (Δ▽◀▶)
- 9 SEARCH button
- 10 Number buttons (0 - 9, +10)
- 11 SLEEP button



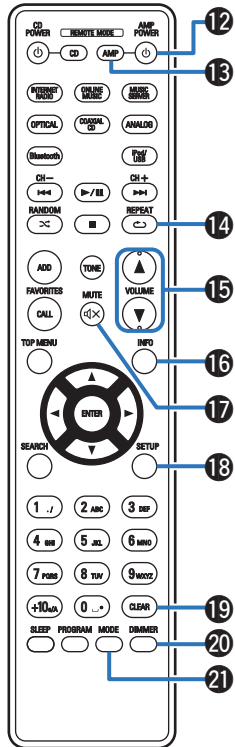

- 12 Power operation button (AMP POWER  $\phi$ )
- 13 Remote mode select button (REMOTE MODE AMP)
- 14 REPEAT button ( $\text{↺}$ )
- 15 VOLUME buttons ( $\blacktriangle$   $\blacktriangledown$ )
- 16 INFO button
- 17 MUTE button ( $\text{⏏}$ )
- 18 SETUP button
- 19 CLEAR button
- 20 DIMMER button
- 21 MODE button



## ■ Contents

Connecting a digital device	16
Connecting an analog device	17
Connecting the power cord	18

### NOTE

- Do not plug in the power cord until all connections have been completed.
- Do not bundle power cords together with connection cables. Doing so can result in humming or noise.

## ■ Cables used for connections

Provide necessary cables according to the devices you want to connect.

Audio cable



Coaxial digital cable  
(supplied)



## Connecting a digital device

This unit can be connected to an amplifier with digital audio (coaxial) input connector.

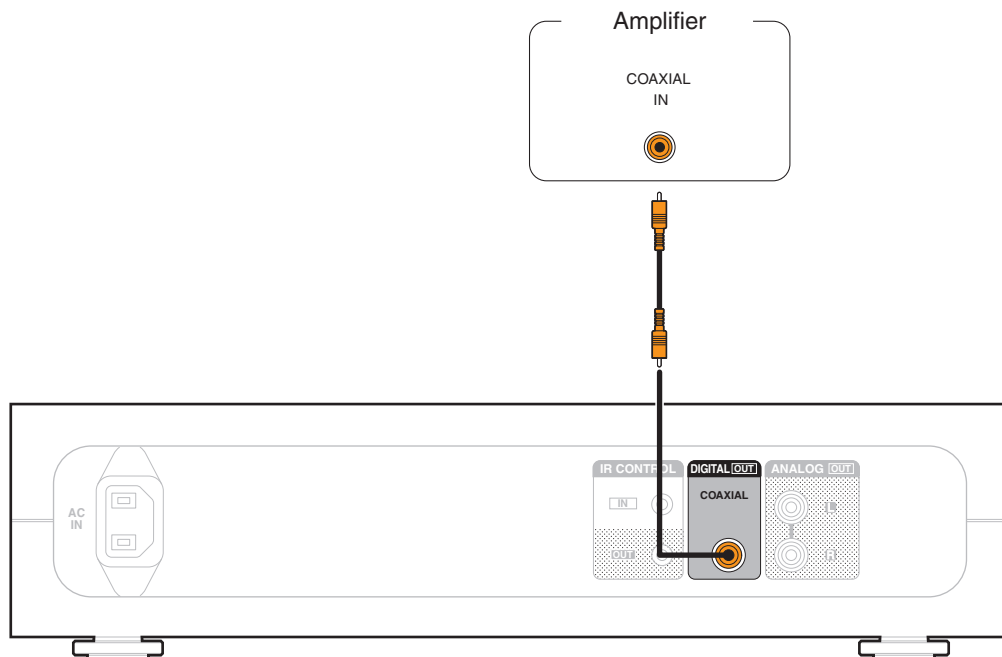



## Connecting an analog device

This unit can be connected to an amplifier with analog audio input connectors.

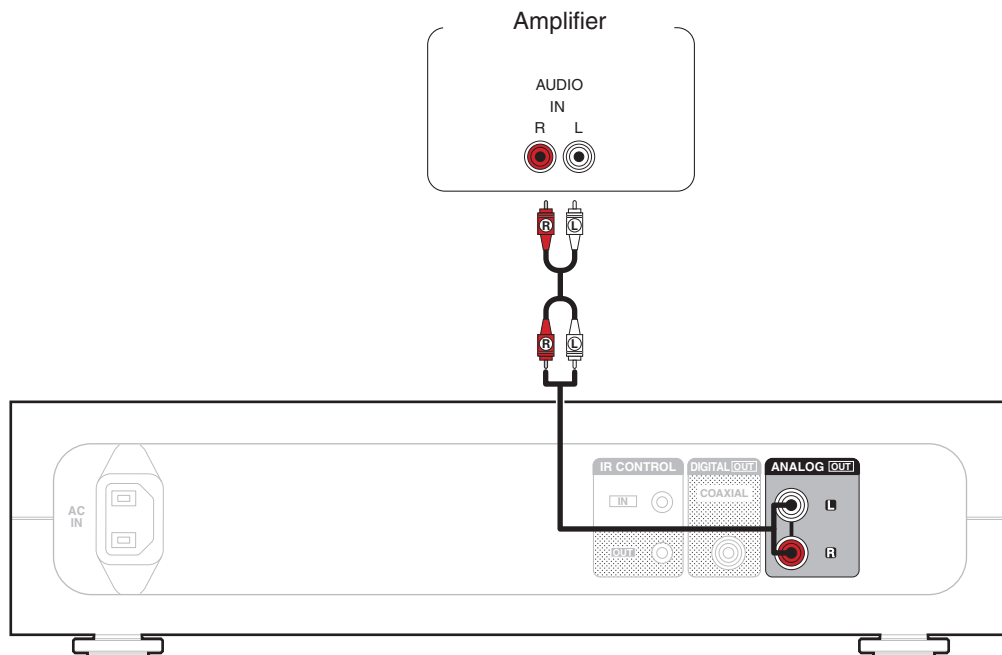

## Connecting the power cord

After completing all the connections, insert the power plug into the power outlet.

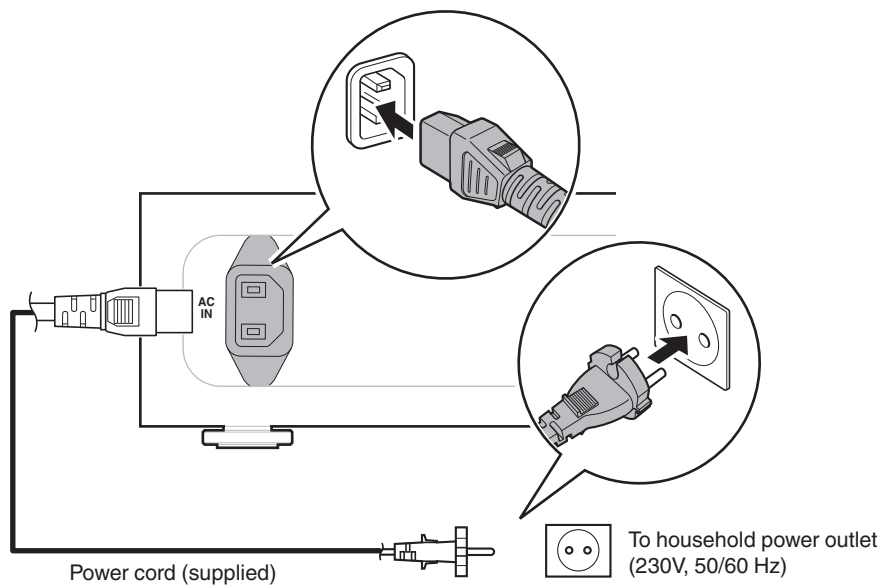

## ■ Contents

Basic operation	20
Playing CDs	22
Playing DATA CDs (MP3 and WMA files)	25



## Basic operation

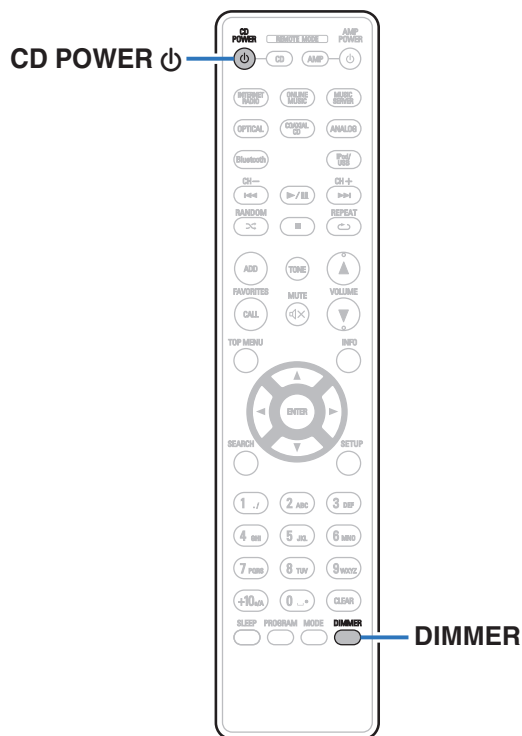

### Turning the power on

- 1 Press **CD POWER** to turn on power to the unit.  
Turns the display on.



- You can also press on the main unit to turn on power from standby mode.

### Switching the power to standby

- 1 Press **CD POWER** .
- Turns the display off.



- You can also switch the power to standby by pressing on the main unit.

#### NOTE

- Power continues to be supplied to some of the circuitry even when the power is in the standby mode. When leaving home for long periods of time or when going on vacation, unplug the power cord from the power outlet.



## Switching the display's brightness

The brightness of the display can be adjusted to one of three levels.

### 1 Press DIMMER.

- The brightness of the display switches each time the button is pressed.



- The display brightness is set to most brightly by default.



# Playing CDs

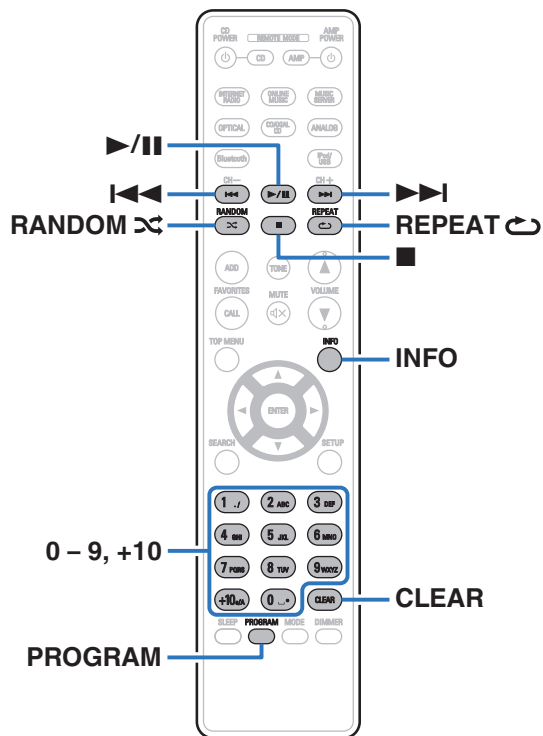

## Playing CDs

**1** Insert a disc. (🔧 p. 39)

**2** Press ▶/||.

The ▶ indicator lights on the display. Playback starts.



You can set whether to automatically play CDs. (🔧 p. 29)





### NOTE

- 8 cm discs cannot be used on this unit. Do not insert 8 cm discs into the CD slot.
- Do not put anything other than a CD to CD slot. Doing so could result in damage.

**■ Eject CDs**

**1** Press ▲ on the main unit while playback is stopped.



Operation buttons	Function
	Play/Pause
	Stop
	Skip to previous track / Skip to next track (Press and hold) Fast-reverse / Fast-forward
<b>0 – 9, +10</b>	Select the track
<b>RANDOM</b> 	Random playback
<b>REPEAT</b> 	Repeat playback <ul style="list-style-type: none"> <li>Switching between All-track repeat and Single-track repeat.</li> </ul>
<b>INFO</b>	Time display switching <ul style="list-style-type: none"> <li>Track elapsed time, Track remaining time and Total remaining time.</li> </ul>

## ■ Playing a specific track (Direct searching)

### 1 Use 0 – 9 and +10 to select the tracks.

#### [Example]

Track 4 :

Press number 4 to select track 4.

Track 12 :

Press numbers +10 and 2 consecutively to select track 12.



## Playing tracks in a specific order (Program playback)

Up to 25 tracks can be programmed.

### 1 In the stop mode, press PROGRAM.

“PROG” is displayed on the display.

### 2 Use 0 – 9 and +10 to select the tracks.



[Example]

To program tracks 3, 12 to play in that order: Press 3, +10 and 2 one after the other.

### 3 Press ►/II.

Playback starts in the programmed order.



- When RANDOM  is pressed during program playback, the programmed tracks are played in random order.
- When REPEAT  is pressed during program playback, the tracks are played repeatedly in the programmed order.

#### NOTE

- The program is cleared when the disc is ejected or the power is turned off.

## ■ Checking the order of the programmed tracks

In the stop mode, press ►►I.

The tracks are shown in the programmed order in the display each time ►►I is pressed.

## ■ To clear the last track programmed

In the stop mode, press CLEAR.

To clear the last track programmed.

The last track programmed is cleared each time the button is pressed.

## ■ Clearing the all programmed track

In the stop mode, press PROGRAM.





## Playing DATA CDs (MP3 and WMA files)

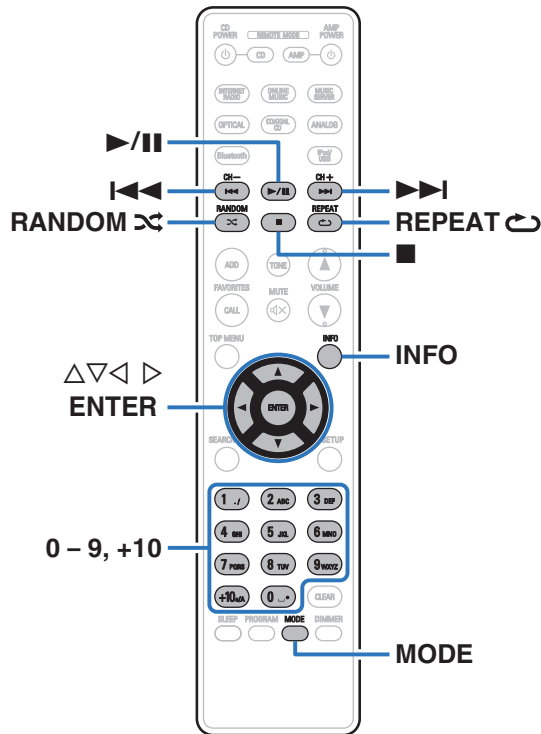

- This section explains how to playback music files that are recorded onto a CD-R or CD-RW.
- There are many music distribution sites on the Internet allowing you to download music files in MP3 or WMA (Windows Media® Audio) format. The music (files) downloaded from such sites can be stored on CD-R or CD-RW discs and played on this unit.

**“Windows Media” and “Windows” are the trademarks or registered trademarks of Microsoft Corporation in the United States and other countries.**

- The audio format types and specifications supported by this unit for playback are as follows.  
See “Playable files” for details. (p. 37)
- MP3
- WMA



## Playing files

**1** Insert a CD-R or CD-RW containing music files into the CD slot. (🔧 p. 39)

**2** Press **MODE** to select the folder mode or all mode.

About the display

- When “Folder mode” is selected

“■” indicator lights.

All the files in the selected folder are played.

- When “All mode” is selected

“■” indicator turns off.

After the selected folder and files are played, all the files in all the folders are played.

**3** Use **Δ∇** to select the folder to be played.

**4** Use **◀▶** to select the file to be played.

**5** Press **▶/||**.

Playback starts.



- You can set whether to automatically play CDs. (🔧 p. 29)

Operation buttons	Function
▶ /	Play/Pause
■	Stop
◀◀ ▶▶	Skip to previous track / Skip to next track (Press and hold) Fast-reverse / Fast-forward
Δ ∇	Folder select
◀ ▶	File select
0 - 9, +10	Select the track
<b>MODE</b>	Switch playback mode <ul style="list-style-type: none"> <li>Switching between playing back all files within the selected folder or all tracks on the disc.</li> </ul>
<b>RANDOM</b> ⌘	Random playback
<b>REPEAT</b> ↺	Repeat playback <ul style="list-style-type: none"> <li>Switching between All-track repeat and Single-track repeat.</li> </ul>



- The folder and file numbers are set automatically when the disc is loaded.



**NOTE**

- Programmed playback is not possible with MP3/WMA discs.
- Copyright-protected files cannot be played.  
If you attempt to play a copyright-protected file, this unit skips the file and plays the next file.  
Note that depending on the software used for burning and other conditions, some files may not play or display correctly.

**Files that can be played back**

See “Playable files” (👉 p. 37).

**To switch the folder or file during playback**

- Folder  
Use  $\Delta \nabla$  to select the folder, then press ENTER.
- Files  
Use  $\triangleleft \triangleright$  to select the file, then press ENTER.  
Also use  $\blacktriangleleft \blacktriangleright$  to select the file, or use 0 – 9, +10 to select the file number.

**Switching the display**

During playback, press INFO.

- Switching between the title name, artist name and album name.
- The player can display the following characters:

ABCDEFGHIJKLMNOPQRSTUVWXYZ

abcdefghijklmnopqrstuvwxyz

0123456789

!"#\$%&:;<>?@\[\]\_`{|}~^'()\*+,-./= (space)

If there is no title, the file name is displayed instead.





## Auto Standby

Sets whether to automatically switch the unit to the standby mode when the unit remains in the stop mode for more than 30 minutes.

### 1 When this unit in the power on, press and hold CD POWER for 5 seconds.

**On**  
(Default): Enable Auto Standby mode.

**Off:** Disable Auto Standby mode.



- Press and hold CD POWER  to turn this setting “On” or “Off”.
  - When the setting is “On”, the display shows “Auto Standby On”.
  - When the setting is “Off”, the display shows “Auto Standby Off”.



## Auto Play

Set whether to automatically start playback after inserting a disc.

### 1 When this unit in the power on, press and hold ►/|| for 5 seconds.

<b>On:</b>	Playback starts automatically.
<b>Off</b> (Default):	Playback does not start automatically.



- Press and hold ►/|| to turn this setting “On” or “Off”.
  - When the setting is “On”, the display shows “Auto Play On”.
  - When the setting is “Off”, the display shows “Auto Play Off”.
- Playback starts automatically when Auto Play is set to On and the power is turned on when a disc is already inserted.

## Sleep timer function

You can have the power automatically switched to standby once a set time has elapsed. This is convenient for listening while going to sleep.

### 1 Press SLEEP during playback and select the setting time.

- The ⏸ indicator on the display lights.
- You can set the sleep timer in the range from 10 to 90 minutes in steps of 10 minutes.

### ■ To cancel the sleep timer

Press SLEEP to set “Sleep Off”.

The ⏸ indicator on the display turns off.



- The sleep timer setting is canceled when the unit switches to standby mode.
- To check the time remaining until the sleep timer is activated, press SLEEP.



## ■ Contents

### Tips

I want to playback just the specified folder	31
I want to start playback automatically after inserting a disc	31
I want to play back music with a single operation from the standby state	31

### Troubleshooting

Power does not turn on / Power is turned off	32
LED is flashing	32
Operations cannot be performed through the remote control unit	33
No sound comes out	33
Sound is interrupted or noise occurs	34
Cannot playback Discs	34
File names or tag data are not displayed correctly	35



## Tips

### I want to playback just the specified folder

- The MODE button to set the playback range to “Folder mode”. (👉 p. 26)

### I want to start playback automatically after inserting a disc

- Turn Auto Play on. (👉 p. 29)

### I want to play back music with a single operation from the standby state

- Make sure that a disc is inserted and then press the ▶/⏸ button on the unit or remote control. Playback starts when the unit powers on.



## Troubleshooting



If a problem should arise, first check the following.

1. **Are the connections correct?**
2. **Is the set being operated as described in the owner's manual?**
3. **Are the other devices operating properly?**

If this unit does not operate properly, check the items listed in the table below.

Should the problem persist, there may be a malfunction. In this case, disconnect the power immediately and contact your store of purchase.

### ■ Power does not turn on / Power is turned off

Symptom	Cause / Solution	Page
Power is not turned on.	• Check whether the power plug is correctly inserted into the power outlet.	<a href="#">18</a>
	• This unit is in standby mode. Press the  button on the unit or CD POWER  button on the remote control.	<a href="#">20</a>
Power automatically turns off.	• The sleep timer is set. Turn on the power again.	<a href="#">29</a>
	• The Auto Standby mode is set. The Auto Standby mode switches the unit to standby mode when the unit is not operated for approximately 30 minutes. To disable the Auto Standby mode, press and hold the CD POWER  button on the remote control unit for more than 5 seconds when the Auto Standby mode is enabled.	<a href="#">28</a>

### ■ LED is flashing

Symptom	Cause / Solution	Page
Flashing red.	• A circuit in the unit has malfunctioned. Disconnect the power and contact the repair center.	—





## ■ Operations cannot be performed through the remote control unit

Symptom	Cause / Solution	Page
Operations cannot be performed through the remote control unit.	• Batteries are worn out. Replace with new batteries.	<u>5</u>
	• Operate the remote control unit within a distance of about 7 m from this unit and at an angle of within 30°.	<u>5</u>
	• Remove any obstacle between this unit and the remote control unit.	—
	• Insert the batteries in the proper direction, checking the ⊕ and ⊖ marks.	<u>5</u>
	• The unit's remote control sensor is exposed to strong light (direct sunlight, inverter type fluorescent bulb light, etc.). Move the unit to a place in which the remote control sensor will not be exposed to strong light.	—
	• When using a 3D video device, the remote control unit of this unit may not function due to effects of infrared communications between units (such as TV and glasses for 3D viewing). In this case, adjust the direction of units with the 3D communications function and their distance to ensure they do not affect operations from the remote control unit of this unit.	—

## ■ No sound comes out

Symptom	Cause / Solution	Page
No sound is produced. Or sound is distorted.	• Check the connections for all devices.	<u>15</u>
	• Insert connection cables all the way in.	—
	• Check that input connectors and output connectors are not reversely connected.	—
	• Check cables for damage.	—
	• Check the amplifier's functions and controls and adjust as necessary.	—



## ■ Sound is interrupted or noise occurs

Symptom	Cause / Solution	Page
During playback from the CD-R/CD-RW, sound is occasionally interrupted.	<ul style="list-style-type: none"> <li>This may be caused by poor recording conditions, or the disc itself may be of poor quality. Use a correctly recorded disc.</li> </ul>	—

## ■ Cannot playback Discs

Symptom	Cause / Solution	Page
Cannot playback when the ►/   button is pressed, or cannot correctly play back a specific part of the disc.	<ul style="list-style-type: none"> <li>The disc is dirty or scratched. Either clean the disc, or insert a different disc.</li> </ul>	<a href="#">40</a>
Cannot playback CD-R/CD-RW.	<ul style="list-style-type: none"> <li>Discs cannot be played back unless they have been finalized. Use a finalized disc.</li> </ul>	<a href="#">36</a>
	<ul style="list-style-type: none"> <li>This may be caused by poor recording conditions, or the disc itself may be of poor quality. Use a correctly recorded disc.</li> </ul>	—
	<ul style="list-style-type: none"> <li>The DATA CD playback function of this unit only supports playback of MP3 and WMA files.</li> </ul>	<a href="#">37</a>
“Unsupported” is displayed.	<ul style="list-style-type: none"> <li>The disc is loaded upside-down.</li> </ul>	<a href="#">39</a>
	<ul style="list-style-type: none"> <li>The disc that cannot be played is loaded.</li> </ul>	<a href="#">39</a>





## ■ File names or tag data are not displayed correctly

Symptom	Cause / Solution	Page
The file names are not displayed properly (“_ _ _”, etc.).	<ul style="list-style-type: none"><li>Characters that cannot be displayed are used. This is not a malfunction. On this unit, characters that cannot be displayed are replaced with a “_”.</li></ul>	—



## Playable media

### Discs

Playable media	
CD	
CD-R	
CD-RW	

#### NOTE

- Some discs and some recording formats may not be playable.
- Non-finalized discs cannot be played.

### Files

CD-R and CD-RW discs created in the format described below can be played.

#### ■ Writing software format

ISO9660 level 1, 2

Expansion format (Juliet)

When written in other formats, it may not be possible to play the disc properly.

#### ■ Maximum number of playable files and folders

Maximum number of folders : 255

Maximum number of files : 999

#### ■ Tag data

ID3-TAG (Ver.1.x and 2.x)

WMA-TAG

(The title, artist, and album tag data are supported)



## ■ Playable files

	Sampling frequency	Bit rate	Extension
<b>MP3</b>	32/44.1/48 kHz	32 – 320 kbps	.mp3
<b>WMA</b>	32/44.1/48 kHz	64 – 192 kbps	.wma

### NOTE

- Be sure to give files the extension “.mp3” or “.wma”. Files with any other extensions or files with no extensions cannot be played.
- Recordings you have made should only be used for your personal enjoyment, and as per copyright laws may not be used in other ways without permission of the copyright holder.

## Playback order of music files

When there are multiple folders containing music files, the playback order of folders is automatically set when this unit reads the media. The files in each folder are played back in the order in which the files were recorded on the media, from the oldest date and time.

### CD-R/CD-RW

For playback of files on CD-R or CD-RW, files in all folders on the first layer are played first, next on the second layer, then next on the third layer, and so on in this order.



- The playback order displayed on a PC may differ from the actual playback order.
- The playback order with a CD-R/CD-RW may differ, depending on the writing software.



## About discs and files

Music files recorded on CD-R/-RW are divided into large segments (folders) and small segments (files). Files are stored in folders, and folders can be placed for storage in a hierarchy. The unit can recognize up to 8 levels of folders.

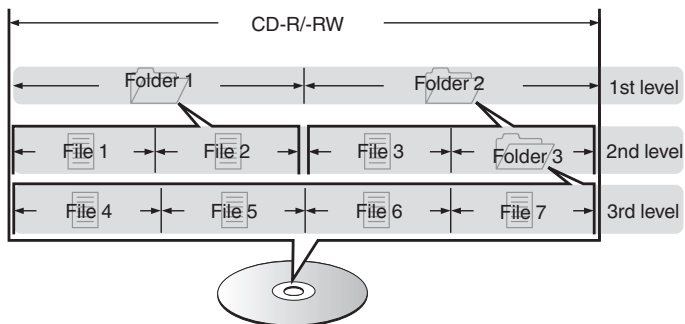

When writing music files on a CD-R/-RW disc, set the writing software's format to "ISO9660". The files may not play properly if they are recorded in other formats. For details, refer to the instructions of your writing software.



## Cautions on using media

### Loading Discs

- Insert the disc with the label side up.
- Insert the disc into the CD slot slowly. Release your hand once the disc is drawn in.

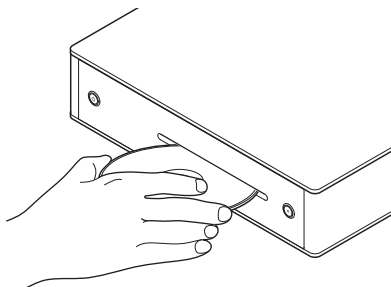

- When no disc is loaded, "No Disc" is displayed.
- When the disc is loaded upside-down, "Unsupported" is displayed.
- When the disc's information could not be read properly, "Unsupported" is displayed.

### Cautions on Loading Discs

- 8 cm discs cannot be used on this player. Do not insert 8 cm discs into the CD slot.
- Do not use an 8 cm disc adapter.
- Only load one disc at a time. Loading two or more discs can damage the unit or scratch the discs.
- Do not use cracked or warped discs or discs that have been repaired with adhesive, etc.
- Do not use discs on which the sticky part of cellophane tape or labels is exposed or on which there are traces of where labels have been removed. Such discs can get caught inside the player and damage it.



## How to handle media

- Do not get fingerprints, oil or dirt on discs.
- Take special care not to scratch discs when removing them from their cases.
- Do not bend or heat discs.
- Do not enlarge the hole in the center.
- Do not write on the labeled (printed) surface with ball-point pens, pencils, etc., or stick new labels on discs.
- Condensation may form on discs if they are moved suddenly from a cold place (outdoors for example) to a warm place, but do not try to dry discs with a hairdryer, etc.
- Do not store discs in the following places:
  1. Places exposed to direct sunlight for long periods of time
  2. Dusty or humid places
  3. Places exposed to heat from heaters, etc.

## Cleaning discs

- If there are fingerprints or dirt on a disc, wipe them off before using the disc.
- Use a commercially available disc cleaning set or a soft cloth to clean discs.



Gently wipe the disc from the inside towards the outside.

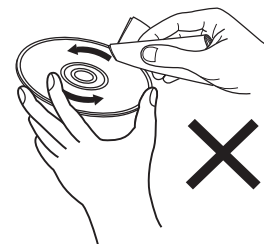

Do not wipe with a circular motion.

### NOTE

- Do not use record spray, antistatic agents, benzene, thinner or other solvents.





## Explanation of terms

---

### MP3 (MPEG Audio Layer-3)

This is an internationally standardized audio data compression scheme, using the “MPEG-1” video compression standard. It compresses the data volume to about one eleventh its original size while maintaining sound quality equivalent to a music CD.

### WMA (Windows Media Audio)

This is audio compression technology developed by Microsoft Corporation.

WMA data can be encoded using Windows Media® Player.

To encode WMA files, only use applications authorized by Microsoft Corporation. If you use an unauthorized application, the file may not work properly.

### Sampling frequency

Sampling involves taking a reading of a sound wave (analog signal) at regular intervals and expressing the height of the wave at each reading in digitized format (producing a digital signal).

The number of readings taken in one second is called the “sampling frequency”. The larger the value, the closer the reproduced sound is to the original.

### Dynamic range

The difference between the maximum undistorted sound level and the minimum discernible level above the noise emitted by the device.

### Bit rate

This is the amount of audio data recorded on a disc that is read in one second.

### Finalizing

This process enables CDs recorded with a CD recorder or drive to be played by other players.

### Linear PCM

This is an uncompressed PCM (Pulse Code Modulation) signal. Unlike lossy compression audio sources such as MP3, no audio quality or dynamic range deteriorates.



# Specifications

---

## ■ Audio performance

- Analog output

<b>Channels:</b>	2-channels
<b>Playable frequency range:</b>	2 Hz – 20 kHz
<b>Playable frequency response:</b>	20 – 20 kHz ( $\pm 1\%$ )
<b>S/N:</b>	105 dB
<b>Dynamic range:</b>	100 dB
<b>Channel Separation:</b>	100 dB
<b>Harmonic distortion:</b>	0.004 % (1 kHz)
<b>Wow &amp; flutter:</b>	Crystal accuracy

- Output level

<b>Signal type:</b>	2 V RMS stereo
---------------------	----------------

- Digital output

<b>Coaxial:</b>	0.5 V <sub>p-p</sub> / 75 $\Omega$ /ohms
-----------------	--

- Optical readout system

<b>Laser:</b>	AlGaAs
<b>Wave length:</b>	780 nm
<b>Signal type:</b>	16-bit linear PCM
<b>Sampling frequency:</b>	44.1 kHz



## ■ General

<b>Power supply:</b>	AC 230 V, 50/60 Hz
<b>Power consumption:</b>	10 W
<b>Power consumption in standby mode:</b>	0.4 W or less
<b>Operating temperatures:</b>	+5 °C - +35 °C
<b>Operating humidity:</b>	5 – 90 % (without dew)

For the purpose of improvement, the specifications and design are subject to change without notice.



## ■ Dimensions (Unit : mm)

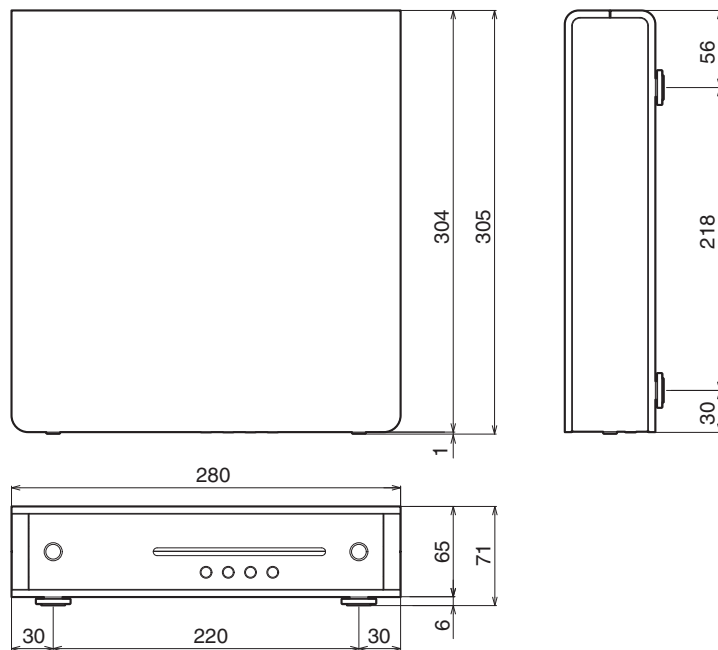

## ■ Weight: 4.2 kg

# Index

---

## A

Analog device .....	17
Auto Play .....	29
Auto Standby .....	28

## C

CDs .....	22
-----------	----

## D

DATA CDs .....	25
Digital device .....	16
Display .....	9
Display's brightness .....	21

## F

Front panel .....	7
-------------------	---

## P

Program playback .....	24
------------------------	----

## R

Rear panel .....	10
Remote control unit .....	11

## S

Sleep timer .....	29
-------------------	----



**DENON<sup>®</sup>**

[www.denon.com](http://www.denon.com)

3520 10550 00AD

Copyright ©2017 D&M Holdings Inc. All Rights Reserved.