

# DENON<sup>®</sup>

## envaya

### DSB50BT, DSB150BT, DSB250BT

Portable Waterproof Speaker

# Owner's Manual



## Preparation

<b>Introduction</b>	<b>4</b>
<b>Unpacking</b>	<b>5</b>
<b>Overview</b>	<b>6</b>
Sound Quality	6
Design	6
Operation	6
<b>Features and functions</b>	<b>7</b>
<b>Attaching the Strap</b>	<b>9</b>
<b>Charging</b>	<b>10</b>
<b>Turning the power on</b>	<b>14</b>
<b>Turning the power off</b>	<b>14</b>

## Connections

<b>Bluetooth operation</b>	<b>15</b>
Pairing	15
Connecting	15
1: Connecting for the first time	16
2: Reconnecting paired devices	18
Simultaneously connecting multiple Bluetooth devices (Multipoint function)	19
Envaya Link (DSB50BT)	20
Envaya Link (DSB150BT/DSB250BT)	21

## Operation

<b>Adjusting the volume</b>	<b>22</b>
<b>Listening to music using a wired connection</b>	<b>23</b>
<b>Voice Control Using Siri</b>	<b>24</b>
<b>Conducting hands-free phone calls using Envaya</b>	<b>25</b>

## Troubleshooting

<b>Tips</b>	<b>27</b>
<b>Troubleshooting</b>	<b>28</b>
Speaker does not turn on	28
Envaya cannot be charged	28
No sound from the speaker	29
Sound is distorted, noisy, or cuts in and out	29
Cannot pair a Bluetooth device with the speaker	30
Speaker is turning off automatically	31
Speaker is malfunctioning	31
Cannot conduct a call	31
<b>Restarting the Envaya</b>	<b>32</b>



## Appendix

<b>Playing back a Bluetooth device</b>	<b>33</b>
<b>Precautions for Dust Resistance and Water Resistance</b>	<b>33</b>
<b>Trademark information</b>	<b>34</b>
<b>Specifications</b>	<b>35</b>
DSB50BT	35
DSB150BT	37
DSB250BT	39
<b>Index</b>	<b>41</b>



# Introduction

---

This manual is for all three models.

For the purposes of this manual, the name “Envaya” is used to refer to the three products.

Their respective model names are used in the model-specific manuals.

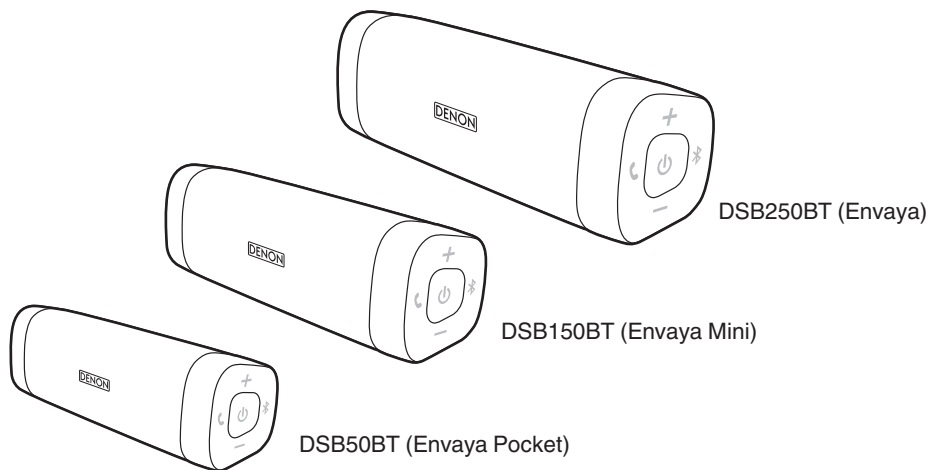

# Unpacking

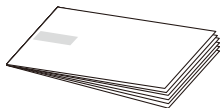

Quick Start Guide

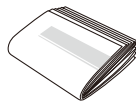

Safety Instructions

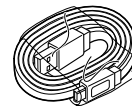

USB Cable



Strap



- USB to AC power adapter not included.



# Overview

## Sound Quality

- Despite the compact size of Envaya, powerful playback sound is produced by using neodymium magnets in the magnetic circuit and utilizing an original surround shape in the passive radiator.
- Envaya is compatible with a wide range of codecs, including the high sound quality Qualcomm® aptX™, AAC and SBC. Envaya automatically selects the optimum compatible codec for your Bluetooth device (smartphone or tablet) so you can enjoy high-grade wireless sound. Additionally, aptX is Low Latency compatible so you can enjoy videos and gaming without audio lag.

## Design

- Envaya has a slim stick design for easy carrying.
- Envaya has a waterproof and dustproof design to keep the unit safe if it gets wet or is exposed to dust clouds. This allows it to be used in a wider range of areas, such as by a pool or in dusty outdoor environments.

## Operation

- Hands-free phone calls can be conducted using Envaya by pairing with a Bluetooth-compatible mobile phone.
- If you have two Envaya units\*, you can make a stereo pair connection between them to create spatial stereo sound.  
\* The two units must be the same model.



## Features and functions

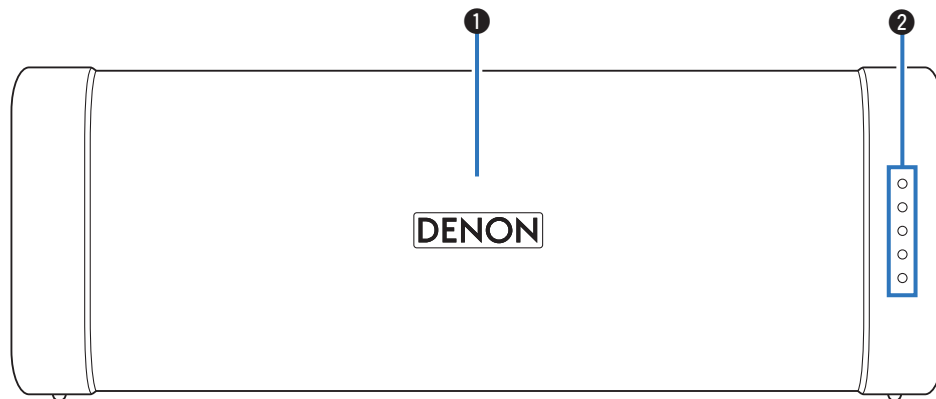

### 1 Microphone

This microphone is used when conducting hands-free phone calls.

(☞ p. 25)

### 2 Status Indicator

Lit when power is on.

Lit when charging. (☞ p. 12)

Lit when pairing. (☞ p. 16)



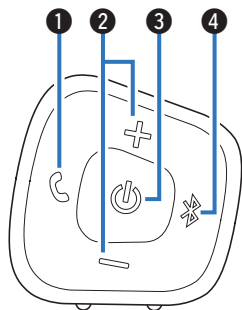

**1 Call button** (☎)

Answers incoming calls and ends calls. (☞ p. 25)

**2 Volume adjustment buttons** (-,+)

Adjusts the volume up and down. (☞ p. 22)

**3 Power button** (⏻)

Turns the power on/off. (☞ p. 14)

**4 Bluetooth button** (📶)

Press this to start pairing. (☞ p. 15)

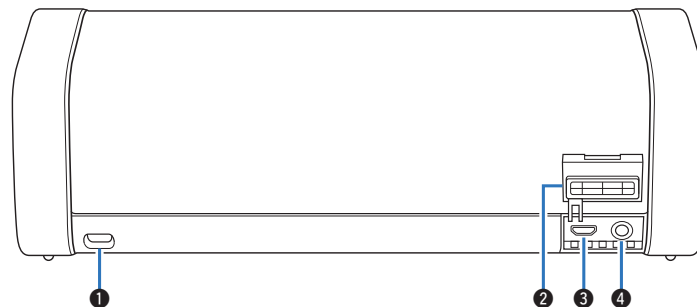

**1 Strap loop**

Attach the provided strap here.

**2 Cap**

Close this cap securely to ensure proper dustproof and waterproof performance.

**3 Micro USB port**

Connect Envaya to the USB to AC power adapter (not included) or the USB port of a computer using the supplied USB cable to charge this unit. (☞ p. 10)

**4 AUX Input connector**

Used to connect an external audio player with an analog output. (☞ p. 23)





## Attaching the Strap

The strap can be attached more easily by using the twist tie that holds it in place.

- 1** Loop the twist tie around the strap.

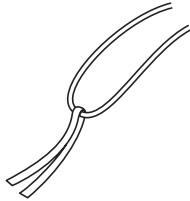

- 2** Pass the twist tie through the strap loop of this unit.

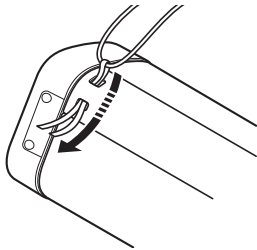

- 3** When the loop of the strap appears on the other side, insert both ends of the strap through the loop to secure it in place.

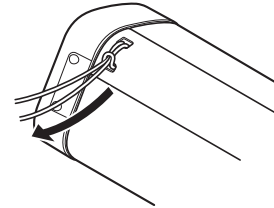

- 4** Tie the ends of the strap securely.

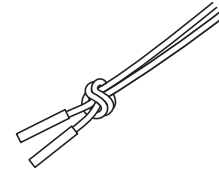

### NOTE

- Do not spin Envaya around holding the strap, as doing so may cause injury or damage.



# Charging

Envaya can be charged and operated on battery power. It can also be operated from an AC power source by connecting it to the USB to AC power adapter (available commercially) or the USB port of a computer using the supplied USB cable. Please make sure you charge the battery completely before listening on battery power.



- After purchase, charge this unit before use.

	DSB50BT	DSB150BT	DSB250BT
Operating life *1 (hours)	10	11	13
Charging time *2 (hours)	2.5	3.0	3.5

\*1 The playback time may differ depending on the ambient temperature, playback volume, and usage conditions.

\*2 If using a USB to AC power adapter with an output of 2A or higher.

## NOTE

- Only use the supplied USB cable.
- The rating of adapter should be less than DC 5V, 2.4A.
- Must be used with an approved adapter suitable for the countries where the requirement will be applied.



## ■ Charging the speaker

- ① Open the cap on the rear side.
- ② Connect the small end of USB cable to the speaker.
- ③ Connect the large end of the USB cable to a USB to AC power adapter and a power source or the USB port on your computer.

### NOTE

- Remove the USB cable and firmly close the cap when charging is completed.

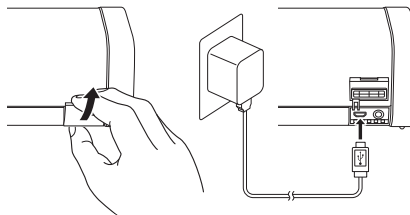

## ■ Battery indicator

The battery indicator uses 5 LEDs to indicate the status of the charge process when connected to the USB to AC power adapter or the USB port of a computer.

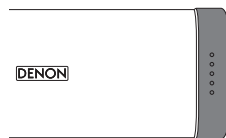

### When connected to the USB to AC power adapter or the USB port of a computer (charging)

The battery indicator is always lit when charging.

The battery indicator turns off when charging is complete.

Charging status (Approximate)	Status Indicator
81 - 99 %	
61 - 80 %	
41 - 60 %	
21 - 40 %	
Less than 20 %	









### When running on battery power

Press and release the  button to check the remaining battery. The remaining battery level is displayed for approximately 2 seconds.



- When the battery indicator flashes on battery power, connect Envaya to the USB to AC power adapter or the USB port of a computer.

Remaining battery (Approximate)	Status Indicator
81 - 100 %	
61 - 80 %	
41 - 60 %	
21 - 40 %	
7 - 20 %	
Less than 7 %	



## Turning the power on

### 1 Press and hold until a notification sound is heard.

The status indicator illuminates and Envaya turns on.

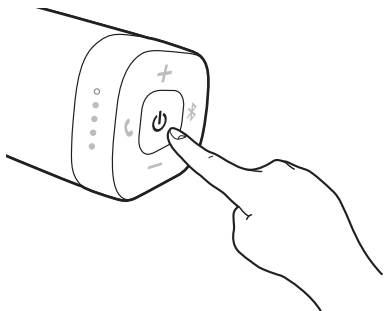

## Turning the power off

### 1 Press and hold until a notification sound is heard.

The status indicator lights turn off and the speaker's power is turned off.



- Envaya automatically turns off when there is no audio output from a Bluetooth device for approximately 15 minutes and the unit is not operated during this time.
- If the stereo mini plug cable is connected to Envaya for approximately 8 hours, Envaya automatically turns off (AUX auto off function).



# Bluetooth operation

You can enjoy listening to music wirelessly by connecting Envaya to your Bluetooth device.

## Pairing

Pairing (registration) is an operation that is required in order to connect a Bluetooth device to Envaya.

When using Bluetooth for the first time, you need to pair Envaya and your Bluetooth device so they can communicate with each other.

Envaya can store pairing information for up to 8 devices.

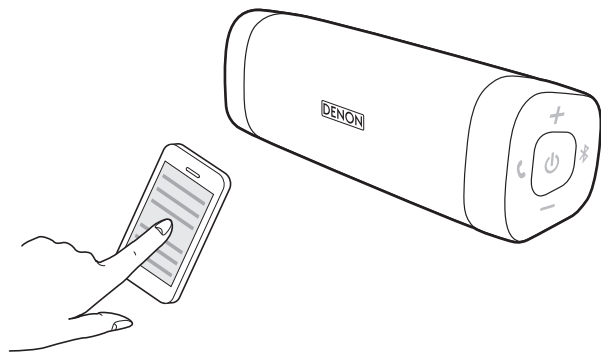

### NOTE

- Multiple Bluetooth devices cannot be played back at the same time.

## Connecting

There are two methods for connecting with Bluetooth devices:

1 Connecting for the first time (☞ p. 16)

2 Reconnecting paired devices (☞ p. 18)



## 1: Connecting for the first time

### 1 Turn on Bluetooth on your mobile device.

- For details, see the Owner's Manual of your Bluetooth device.

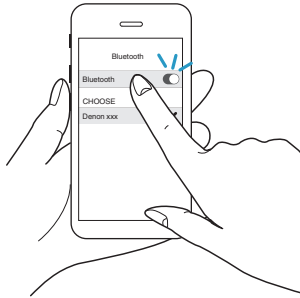

### 2 Press and hold until a notification sound is heard.

The status indicator illuminates and Envaya turns on.

- Envaya automatically enters pairing mode the first time the power is turned on after purchase. In this case, you do not need to perform step 3.

### 3 Press the button.

The status indicator blinks rapidly and Envaya enters pairing mode.

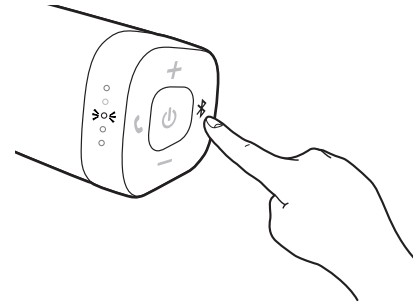



## 4 Select “Denon Envaya xxx”<sup>\*1</sup> from the list of devices displayed on the screen of your Bluetooth device.

When pairing is complete a notification sound is heard.

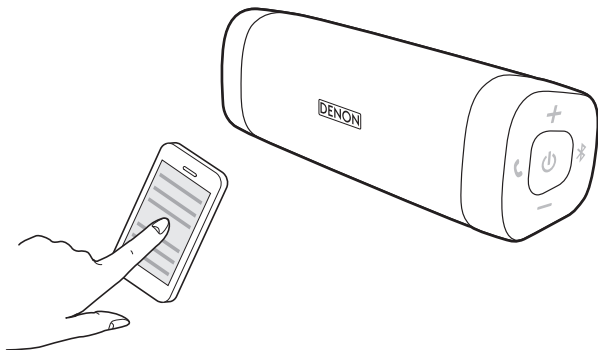

- If you are asked to enter a pass key in the Bluetooth device screen, enter “0000”.

### NOTE

- \*1: The name displayed depends on the model.  
DSB50BT: Denon Envaya Pocket  
DSB150BT: Denon Envaya Mini  
DSB250BT: Denon Envaya

## 5 Listening to music.

Music played back on the Bluetooth device will now play through your Envaya speaker.



- Adjust the volume to an appropriate level.

### NOTE

- Envaya remains in the pairing mode for approximately 5 minutes and then will exit pairing mode. If your device could not connect, please try again from step 3.
- Envaya cannot pair with Bluetooth devices that require a pass key other than “0000”.



## 2: Reconnecting paired devices

### 1 Turn on Bluetooth on your mobile device.

- For details, see the Owner's Manual of your Bluetooth device.

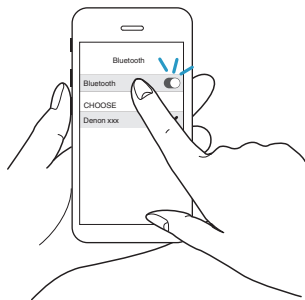

### 2 Press and hold until a notification sound is heard.

The status indicator illuminates and Envaya turns on.

- If the last device which was connected to Envaya is turned on, in range, and has Bluetooth enabled, it automatically connects to Envaya.
- If the stereo mini plug cable is connected to Envaya, remove the cable to switch to the Bluetooth input.

### 3 Select “Denon Envaya xxx”<sup>\*1</sup> from the list of devices displayed on the screen of your Bluetooth device.

When a device is connected by Bluetooth, a notification sound is heard.

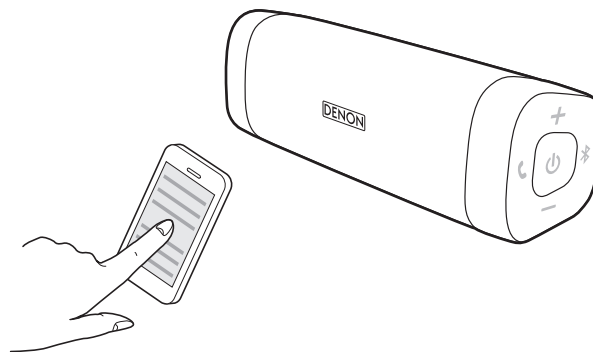

#### NOTE

- <sup>\*1</sup>: The name displayed depends on the model.  
DSB50BT: Denon Envaya Pocket  
DSB150BT: Denon Envaya Mini  
DSB250BT: Denon Envaya

### 4 Listening to music.

Music played back on the Bluetooth device will now play through your Envaya speaker.



## Simultaneously connecting multiple Bluetooth devices (Multipoint function)

Two Bluetooth devices can be simultaneously connected to Envaya so you can easily switch between multiple Bluetooth audio sources without having to disconnect and reconnect each device. ("Bluetooth operation" (🔗 p. 15))

It is convenient to connect devices that you use frequently so that you do not need to re-connect each time you want to switch playback devices. Pair the devices that you want to connect in advance.

--- Audio signal

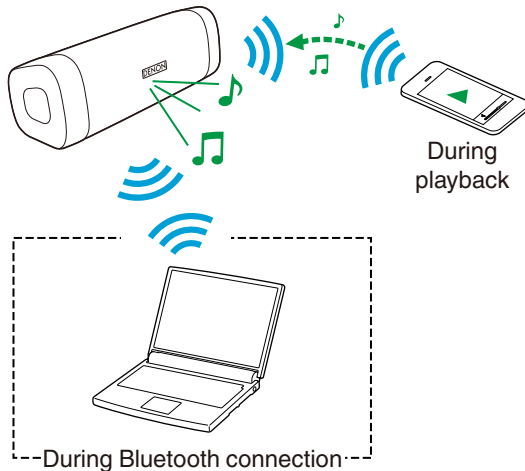

### ■ Switching playback devices

- 1 Stop or pause playback on the device that you are currently listening to.
- 2 Begin playback on the device that you want to listen to.

### ■ Disconnecting the bluetooth connection

Disconnect the Bluetooth connection by turning off the Bluetooth function of the Bluetooth device.



## Envaya Link (DSB50BT)

If you have two of the same speakers, you can use them as a pair of stereo speakers.

- 1** Connect the first Envaya to the Bluetooth device.
- 2** Press and hold the Bluetooth buttons simultaneously on both Envayas for approximately 6 seconds.

### NOTE

- Adjust the volume on the Bluetooth device.
- Envaya Link is disconnected when the Envaya power is turned off. You need to reconnect Envaya Link in order to use it again.

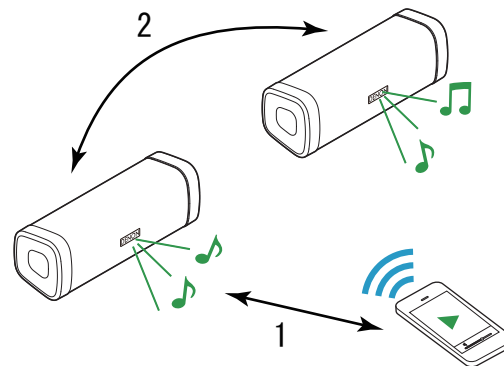

## Envaya Link (DSB150BT/DSB250BT)

If you have two of the same speakers, you can use them as a pair of stereo speakers.

- 1** Connect the first Envaya to the Bluetooth device.
- 2** Press and hold the Bluetooth buttons simultaneously on both Envayas for approximately 6 seconds.

### NOTE

- When Envaya Link is connected, the volume of each Envaya is fixed to the maximum value. Adjust the volume on the Bluetooth device.
- Lower the volume on the Bluetooth device initially before playing music, then adjust the volume to the appropriate level.
- Envaya Link is disconnected when the Envaya power is turned off. You need to reconnect Envaya Link in order to use it again.

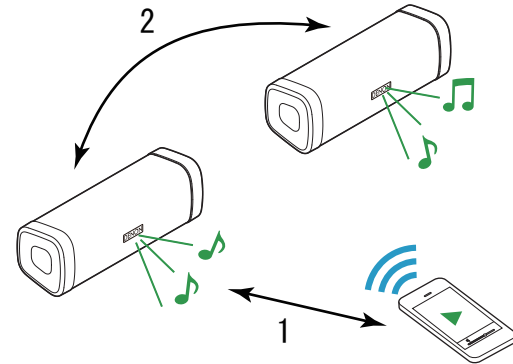

## Adjusting the volume

---

**1** While playing music, press the + button to increase the volume. Press the – button to decrease the volume.

- For the best signal to noise ratio, you may have to raise the volume of your connected music player up to an appropriate level then adjust the volume of the speaker up or down.

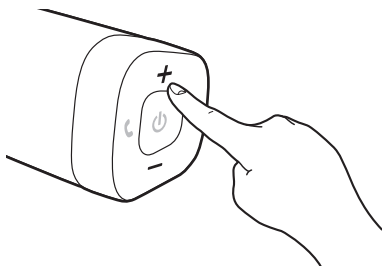

## Listening to music using a wired connection

You can enjoy listening to music from devices that do not support Bluetooth audio by connecting to Envaya using a stereo mini plug cable (available commercially).

### 1 Press and hold until a notification sound is heard.

The status indicator illuminates and Envaya turns on.

### 2 Connect the AUX input connector on Envaya to the headphones jack of the portable music player using a stereo mini plug cable (available commercially).

When a Bluetooth device is playing back music, Bluetooth playback takes priority. Stop playback on the Bluetooth device and then connect the mini plug cable.

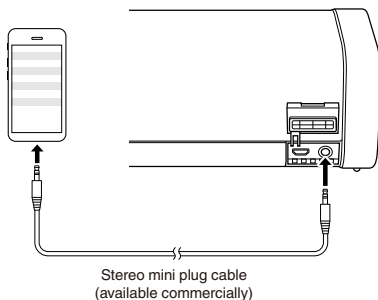

### 3 Start playing music from the device. You may need to adjust the volume up on the connected device, then adjust the volume on Envaya.

Bluetooth connection takes priority on Envaya. If Bluetooth playback is started while a cable is connected, input switches to Bluetooth.



## Voice Control Using Siri

---

If the Bluetooth device is an iPhone or iPad (iOS device), you can use Siri to control Envaya.

### 1 Press and hold the button.

Siri starts.

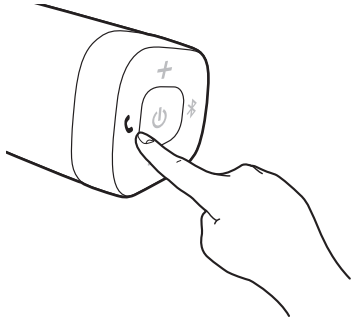

### 2 Speak into the Envaya microphone.



- iPhone, iPad and Siri are trademarks of Apple Inc., registered in the U.S. and other countries.





## Conducting hands-free phone calls using Envaya

If your mobile phone supports the Hands-Free profile (HFP), you can answer incoming calls to your mobile phone from Envaya when the devices are connected by Bluetooth.

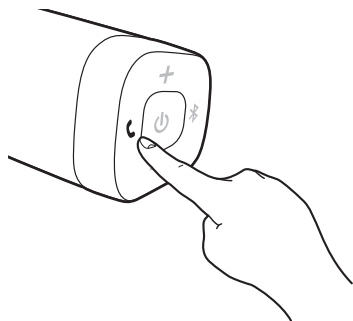

### ■ Answering an incoming call

If a mobile phone connected to Envaya receives an incoming call, the music being played is paused and Envaya plays a ring tone.

Press and release the  button on Envaya while the ring tone plays to answer an incoming call.

Speak into the microphone on Envaya.

### ■ Ending a call

Press the  button on Envaya while a call is in progress to end the call. If you were playing music before the call, playback of the music resumes.

### ■ Canceling an incoming call

Press and hold the  button on Envaya for approximately two seconds while the ring tone plays to cancel an incoming call.



## Tips

I want to answer incoming calls to my mobile phone on Envaya	27
Connecting multiple Bluetooth devices and switching easily between them	27

## Troubleshooting



Speaker does not turn on	28
Envaya cannot be charged	28
No sound from the speaker	29
Sound is distorted, noisy, or cuts in and out	29
Cannot pair a Bluetooth device with the speaker	30
Speaker is turning off automatically	31
Speaker is malfunctioning	31
Cannot conduct a call	31



## Tips

---

### I want to answer incoming calls to my mobile phone on Envaya

- If a mobile phone connected by Bluetooth receives an incoming call, the music being played is paused and a ring tone plays. Press and release the  button on Envaya to answer the call. ( p. 25)

### Connecting multiple Bluetooth devices and switching easily between them

- Music can only be output from Envaya from one Bluetooth device connected using Bluetooth, but two Bluetooth devices can be simultaneously connected to Envaya. To switch easily between connections, connect Bluetooth devices that you use frequently to Envaya. To switch playback to a different Bluetooth device when multiple Bluetooth devices are connected, stop or pause playback on the device that is currently playing back, and then start playback on a different Bluetooth device. ( p. 19)



# Troubleshooting

## Check all connections.

If Envaya does not operate properly, check the items listed in the table below.

Should the problem persist, there may be a malfunction. In this case, disconnect the power immediately and contact your store of purchase.

\* If you need additional help in solving problems, contact Denon customer service in your area.

For more information, visit [www.denon.com](http://www.denon.com).

## Speaker does not turn on

### Speaker does not turn on. (AC power)

- To turn on the speaker, press and hold the power button for 2 seconds. (👉 p. 14)

### Speaker does not turn on. (Battery power)

- The battery is completely discharged. Connect Envaya to the USB to AC power adapter or the USB port of a computer to charge Envaya. (👉 p. 11)

## Envaya cannot be charged

### Envaya cannot be charged.

- The speaker is not connected to a USB to AC power adapter.  
Make sure the USB to AC power adapter is connected to a working power source (AC wall outlet). (👉 p. 11)
- Make sure the supplied USB cable is correctly connected to Envaya. (👉 p. 11)
- If Envaya is connected to the USB port of a computer, make sure the computer is turned on.



## No sound from the speaker

### No sound from the speaker.

- The speaker is not connected to USB to AC power adapter or the battery is not charged. Connect power and turn on the speaker. (🔗 p. 14)
- The volume is too low on your connected device. Turn up the volume on your device to about 90 % and then adjust the volume on the speaker. (🔗 p. 22)
- There is no connected Bluetooth device. Pair and connect a Bluetooth device and try again. (🔗 p. 15)
- There is no connected AUX device. Connect an audio device to the AUX input using a stereo 3.5mm cable and make sure music playing music on your device. (🔗 p. 23)
- The AUX input connector of Envaya is compatible with stereo mini plug cables that have 3-conductor plugs. Be sure to use a 3-conductor stereo mini plug cable. (🔗 p. 23)

## Sound is distorted, noisy, or cuts in and out

### Sound is distorted, noisy, or cuts in and out.

- The volume is too low on your connected device. Turn up the volume on your device to about 90 % and then adjust the volume on the speaker. (🔗 p. 22)
- The Bluetooth device is out of range. Bring the Bluetooth device closer to the speaker.
- The Bluetooth connection is experiencing wireless interference. Move the speaker away from appliances such as microwave ovens and other wireless devices.
- The Bluetooth device is having connectivity issues. Cycle the power on the Bluetooth and reconnect to the speaker.
- Depending on the type of USB to AC power adapter connected to Envaya, a small amount of noise may occur during charging. This is not a malfunction.



## Cannot pair a Bluetooth device with the speaker

### Cannot pair a Bluetooth device with the speaker.

- Power On the speaker then press the  button. Make sure your mobile device has Bluetooth On and select “Denon Envaya \*\*\*\*” from the list of Bluetooth devices.
- The Bluetooth connection is experiencing wireless interference. Move the speaker away from appliances such as microwave ovens and other wireless devices.
- The Bluetooth device is out of range. Bring the Bluetooth device closer to the speaker.
- The Bluetooth device is malfunctioning. Power cycle the device and try again.
- The Bluetooth device is malfunctioning. Power cycle the device, remove the pairing information (Forget this Device on iOS and Unpair on Android) and re-pair the speaker to the device.
- Bluetooth is off on the device. Make sure Bluetooth is set to ON on your device.
- If the stereo mini plug cable is connected, remove the cable.



## Speaker is turning off automatically

### Speaker is turning off automatically.





- To save battery power, the speaker is designed to turn off when no audio is played via Bluetooth for approximately 15 minutes. Power on the speaker by pressing and holding the power button for 2 seconds. (🔧 p. 14)
- If the input of Envaya is set to AUX for approximately 8 hours, Envaya automatically turns off. Power on the speaker by pressing and holding the power button for 2 seconds. (🔧 p. 14)

### The power turns off quickly.

- If usage time is extremely short even when the battery has been fully charged, the battery may be near the end of its life. In this case, please contact Denon service center.

## Speaker is malfunctioning

### Speaker is malfunctioning.

- To reset the speaker, turn on the speaker then, press and release the ,  and  button simultaneously. Envaya is reset. (Note: The battery protection circuit activates after resetting. To restart this unit, charge the battery)
- The speaker needs to be reset to the factory default settings. Turn on the speaker. Press and hold the VOLUME+, VOLUME- and  buttons together for approximately 5 seconds.  
(Note: All pairing information from Bluetooth devices will be erased. The battery protection circuit activates after resetting. To restart this unit, charge the battery).



## Cannot conduct a call

### Cannot conduct a call

- Not all mobile phones and Apps support Hands-free phone calling.



## Restarting the Envaya

To reset the speaker, turn on the speaker then, press and release the ,  and  button simultaneously. Envaya is reset.

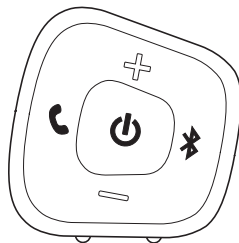

### NOTE

- The battery protection circuit activates after resetting. To restart this unit, charge the battery.





## Playing back a Bluetooth device

---

Envaya supports the following Bluetooth profile.

- **A2DP (Advanced Audio Distribution Profile):**  
When a Bluetooth device that supports this standard is connected, monaural and stereo sound data can be streamed at a high quality.
- **AVRCP (Audio/Video Remote Control Profile):**  
When a Bluetooth device that supports this standard is connected, the Bluetooth device can be operated from Envaya.
- **HFP (Hands-Free profile):**  
When a Bluetooth device that supports this standard is connected, hands-free calls can be conducted via Envaya.

### ■ About Bluetooth Communications

Radio waves broadcast from Envaya may interfere with the operation of medical devices. Make sure you turn off the power of Envaya and Bluetooth device in the following locations as radio wave interference may cause malfunctions.

- Hospitals, trains, aircraft, petrol kiosks and places where flammable gases are generated
- Near automatic doors and fire alarms

## Precautions for Dust Resistance and Water Resistance

---

Envaya has IP67 water and dust resistance.

IP6X: Protection level against dust: Protected from total dust ingress

IPX7: Protection level against water: Can withstand being submerged in 1m of static water for up to 30 minutes without water entering the device.

- Envaya is not completely water resistant, and therefore cannot be used in water.
- Dust and water resistance cannot be guaranteed when the cap is open. Fasten the cap tightly.
- Resistance to liquids other than tap water at normal temperature (such as liquid soap, detergent solution, bath water, shampoo, spa water, hot water, swimming pool water, sea water, etc.) is not guaranteed.
- In the unlikely event that water gets into Envaya, stop use immediately and contact the vendor. Please note that any water damage occurring as a result of the mistaken use of Envaya is not covered by the warranty.
- If this unit gets dirty, wipe the dirt off with a soft, dry cloth. If it is badly soiled, wipe it with a cloth soaked in diluted neutral detergent and then wipe it dry with a dry cloth.



## Trademark information

---



The Bluetooth® word mark and logos are registered trademarks owned by Bluetooth SIG, Inc. and any use of such marks by D&M Holdings Inc. is under license. Other trademarks and trade names are those of their respective owners.



Qualcomm aptX is a product of Qualcomm Technologies International, Ltd.

Qualcomm is a trademark of Qualcomm Incorporated, registered in the United States and other countries, used with permission. aptX is a trademark of Qualcomm Technologies International, Ltd., registered in the United States and other countries, used with permission.



# Specifications

## DSB50BT

### ■ Speaker section

Type:	40 mm full range × 2 40 × 83 mm passive radiator × 1
-------	---

### ■ Bluetooth section

Communication system:	Bluetooth Specification version 4.2
Compatible Bluetooth profiles:	A2DP/AVRCP/HFP
Supported codecs:	aptX Low Latency/AAC/SBC
Supported content protection:	SCMS-T method

### ■ General

Input	5 V $\overline{\text{---}}$ 2.1 A
Power consumption (power off)	8 mW
Battery	
Operating life	10 hours
Charging time	2.5 hours
Dustproof specifications	Equivalent to IP6X
Waterproof specifications	Equivalent to IPX7

\* For purposes of improvement, specifications and design are subject to change without notice.



## ■ Dimensions (Unit : mm)

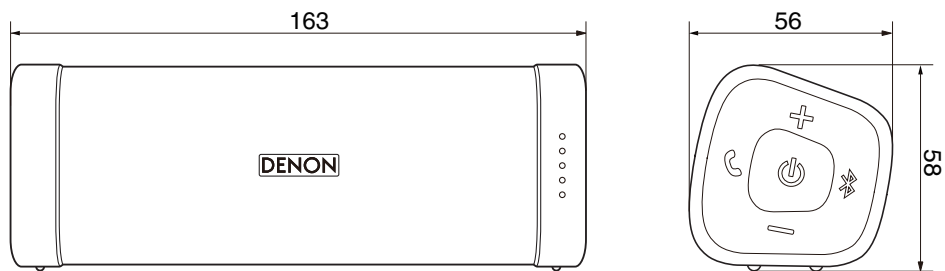

■ Weight: 390 g



## DSB150BT

### ■ Speaker section

Type:	40 mm full range × 2 40 × 83 mm passive radiator × 1
-------	---

### ■ Bluetooth section

Communication system:	Bluetooth Specification version 4.2
Compatible Bluetooth profiles:	A2DP/AVRCP/HFP
Supported codecs:	aptX Low Latency/AAC/SBC
Supported content protection:	SCMS-T method

### ■ General

Input	5 V $\overline{\text{---}}$ 2.1 A
Power consumption (power off)	8 mW
Battery	
Operating life	11 hours
Charging time	3.0 hours
Dustproof specifications	Equivalent to IP6X
Waterproof specifications	Equivalent to IPX7

\* For purposes of improvement, specifications and design are subject to change without notice.



## ■ Dimensions (Unit : mm)

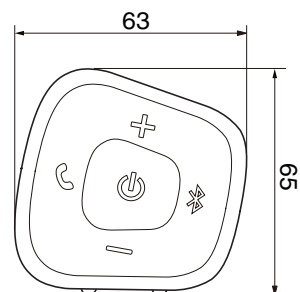
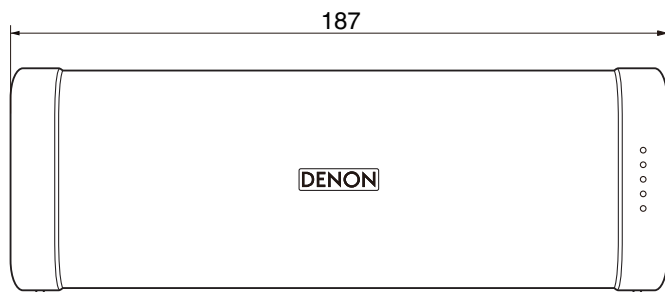

■ Weight: 541 g



## DSB250BT

### ■ Speaker section

Type:	40 mm full range × 2 53 × 135 mm passive radiator × 1
-------	--

### ■ Bluetooth section

Communication system:	Bluetooth Specification version 4.2
Compatible Bluetooth profiles:	A2DP/AVRCP/HFP
Supported codecs:	aptX Low Latency/AAC/SBC
Supported content protection:	SCMS-T method

### ■ General

Input	5 V $\overline{\text{---}}$ 2.1 A
Power consumption (power off)	12 mW
Battery	
Operating life	13 hours
Charging time	3.5 hours
Dustproof specifications	Equivalent to IP6X
Waterproof specifications	Equivalent to IPX7

\* For purposes of improvement, specifications and design are subject to change without notice.



## ■ Dimensions (Unit : mm)

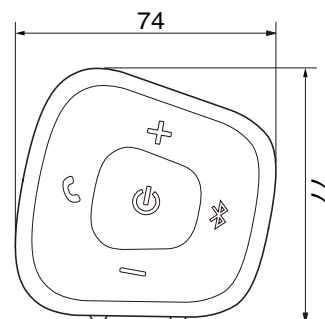
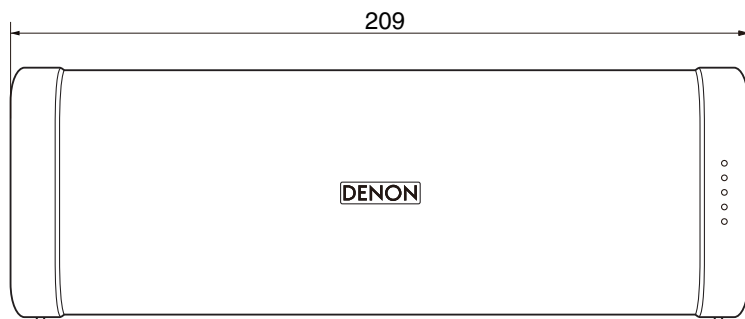













■ Weight: 750 g





# Index

 <b>A</b>		 <b>M</b>		 <b>T</b>	
Accessories .....	5	Multipoint function .....	19	Troubleshooting .....	28
AUX auto off function .....	14	 <b>P</b>		Turning the power off .....	14
 <b>C</b>		Pairing .....	15	Turning the power on .....	14
Charging .....	10	Playback Bluetooth device .....	15	 <b>U</b>	
 <b>F</b>		 <b>R</b>		USB Cable .....	11
Features and functions .....	7	Remaining battery indicator .....	12	 <b>V</b>	
 <b>H</b>		Restarting the unit .....	32	Volume adjustment .....	22
Hands-free function .....	25	 <b>S</b>		 <b>W</b>	
		Stereo mini plug cable .....	23	Wired connection (AUX) .....	23



**DENON®**  
[www.denon.com](http://www.denon.com)

D&M Holdings Inc.  
3520 10564 00AD