

# DENON

**GUI** *Graphical User Interface*

Use this manual in combination with the operating guide displayed on the GUI screen.

GUI Menu Operation (📖 page 23)

GUI Menu Map (📖 page 24)

Language (📖 page 42)

Remote Control Unit Operations (📖 page 66)

## AV SURROUND PRE-AMPLIFIER

# AVP-A1HD

### Owner's Manual



- Instructions in languages other than English are included on the CD-ROM. For details, see page 3.
- Anleitungen in einer anderen Sprache als Englisch befinden sich auf der CD-ROM. Hinsichtlich der Einzelheiten lesen Sie bitte die Seite 3.
- Le mode d'emploi dans les langues autres que l'anglais est fourni sur le CD-ROM. Pour plus de détails, voir page 3.
- Istruzioni in lingue diverse dall'inglese sono incluse nel CD-ROM. Per informazioni, vedere le pagina 3.
- Las instrucciones en los otros idiomas que no sean el inglés se suministran en el CD-ROM. Para obtener más información, consulte las página 3.
- Op de CD-ROM vindt u gebruiksaanwijzingen in andere talen dan het Engels. Zie blz. 3 voor meer informatie.
- Instruktioner på andra språk än engelska finns på CD-ROM-skivan. Se sidan 3 för detaljer.

**SAFETY PRECAUTIONS**



**CAUTION**  
**RISK OF ELECTRIC SHOCK**  
**DO NOT OPEN**



**CAUTION:**  
**TO REDUCE THE RISK OF ELECTRIC SHOCK, DO NOT REMOVE COVER (OR BACK). NO USER-SERVICEABLE PARTS INSIDE. REFER SERVICING TO QUALIFIED SERVICE PERSONNEL.**

The lightning flash with arrowhead symbol, within an equilateral triangle, is intended to alert the user to the presence of uninsulated "dangerous voltage" within the product's enclosure that may be of sufficient magnitude to constitute a risk of electric shock to persons.

The exclamation point within an equilateral triangle is intended to alert the user to the presence of important operating and maintenance (servicing) instructions in the literature accompanying the appliance.

**WARNING:**  
**TO REDUCE THE RISK OF FIRE OR ELECTRIC SHOCK, DO NOT EXPOSE THIS APPLIANCE TO RAIN OR MOISTURE.**

**CE 0413**  **R&TTE Directive 1999/5/EC**

This product may be operated in the following countries;

AT	BE	CZ	DK	FI
FR	DE	GR	HU	IE
IT	NL	PL	PT	SK
ES	SE	GB	NO	CH

**• DECLARATION OF CONFORMITY**  
Hereby, D&M Holdings Inc., Denon Brand Company declares that this product AVP-A1HD is in compliance with the essential requirements and other relevant provisions of Directive 1999/5/EC, in conformity with the following standards;  
EN60065, EN55013, EN55020, EN55022, EN55024, EN61000-3-2, EN61000-3-3, EN300328, EN301489-01, EN301489-17 and EN50385  
The declaration of conformity may be consulted to our European representative, DENON Europe.

**• ÜBEREINSTIMMUNGSERKLÄRUNG**  
Hiermit erklärt D&M Holdings Inc., Denon Brand Company, dass sich das Gerät AVP-A1HD in Übereinstimmung mit den grundlegenden Anforderungen und den übrigen einschlägigen Bestimmungen der Richtlinie 1999/5/EG befindet, den folgenden Standards entspricht:  
EN60065, EN55013, EN55020, EN55022, EN55024, EN61000-3-2, EN61000-3-3, EN300328, EN301489-01, EN301489-17 und EN50385  
Wenden Sie sich bei Fragen zur Konformitätserklärung an unseren europäischen Vertreter, DENON Europe.

**• DECLARATION DE CONFORMITE**  
Par la présente, D&M Holdings Inc., Denon Brand Company déclare que l'appareil AVP-A1HD est conforme aux exigences essentielles et aux autres dispositions pertinentes de la directive 1999/5/CE, e conforme alle seguenti normative:  
EN60065, EN55013, EN55020, EN55022, EN55024, EN61000-3-2, EN61000-3-3, EN300328, EN301489-01, EN301489-17 e EN50385.  
La déclaration de conformité pourra être consultée auprès de notre représentant en Europe, DENON Europe.

**• DICHIARAZIONE DI CONFORMITÀ**  
Con la presente D&M Holdings Inc., Denon Brand Company dichiara che questo AVP-A1HD è conforme ai requisiti essenziali ed alle altre disposizioni pertinenti stabilite dalla direttiva 1999/5/CE, e conforme alle seguenti normative:  
EN60065, EN55013, EN55020, EN55022, EN55024, EN61000-3-2, EN61000-3-3, EN300328, EN301489-01, EN301489-17 e EN50385.  
La dichiarazione di conformità può essere consultata presso il nostro rappresentante europeo, DENON Europe.  
QUESTO PRODOTTO E' CONFORME  
AL D.M. 28/08/95 N. 548

**• DECLARACIÓN DE CONFORMIDAD**  
Por la presente, D&M Holdings Inc., Denon Brand Company, declara que este AVP-A1HD cumple con los requisitos esenciales y otras exigencias relevantes de la Directiva 1999/5/EC, esta conforme con los siguientes estandares:  
EN60065, EN55013, EN55020, EN55022, EN55024, EN61000-3-2, EN61000-3-3, EN300328, EN301489-01, EN301489-17 y EN50385.  
Puede consultar a nuestro representante europeo, DENON Europe, acerca de la declaración de conformidad.

**• EENVORMIGHEIDSVERKLARING**  
Hierbij verklaart D&M Holdings Inc., Denon Brand Company dat het toestel AVP-A1HD in overeenstemming is met de essentiële eisen en de andere relevante bepalingen van richtlijn 1999/5/EG, in overeenstemming is met de volgende normen:  
EN60065, EN55013, EN55020, EN55022, EN55024, EN61000-3-2, EN61000-3-3, EN300328, EN301489-01, EN301489-17 en EN50385.  
De eenvormigheidsverklaring mag worden geconsulteerd aan onze Europese vertegenwoordiger, DENON Europe.

**• ÖVERENSSTÄMMELSEINTYG**  
D&M Holdings Inc., Denon Brand Company intygar härmed att denna produkt, AVP-A1HD, uppfyller huvudkraven och relevanta bestämmelser i Direktiv 1999/11/EG samt att produkten är i överensstämmelse med följande standarder:  
EN60065, EN55013, EN55020, EN55022, EN55024, EN61000-3-2, EN61000-3-3, EN300328, EN301489-01, EN301489-17 och EN50385.  
EU-konformitetsintyget kan på begäran fås från DENON Europe, vår representant i Europe.

DENON Europe  
Division of D&M Germany GmbH  
An der Landwehr 19, Nettetal,  
D-41334 Germany

**CAUTION:**  
To completely disconnect this product from the mains, disconnect the plug from the wall socket outlet.  
The mains plug is used to completely interrupt the power supply to the unit and must be within easy access by the user.

**VORSICHT:**  
Um dieses Gerät vollständig von der Stromversorgung abzutrennen, ziehen Sie bitte den Stecker aus der Wandsteckdose.  
Der Netzstecker wird verwendet, um die Stromversorgung zum Gerät völlig zu unterbrechen; er muss für den Benutzer gut und einfach zu erreichen sein.

**PRECAUTION:**  
Pour déconnecter complètement ce produit du courant secteur, débranchez la prise de la prise murale.  
La prise secteur est utilisée pour couper complètement l'alimentation de l'appareil et l'utilisateur doit pouvoir y accéder facilement.







**ATTENZIONE:**  
Per scollegare completamente questo prodotto dalla rete di alimentazione elettrica, scollegare la spina dalla relativa presa a muro.  
La spina di rete viene utilizzata per interrompere completamente l'alimentazione all'unità e deve essere facilmente accessibile all'utente.

**PRECAUCIÓN:**  
Para desconectar completamente este producto de la alimentación eléctrica, desconecte el enchufe del enchufe de la pared.  
El enchufe de la alimentación eléctrica se utiliza para interrumpir por completo el suministro de alimentación eléctrica a la unidad y debe de encontrarse en un lugar al que el usuario tenga fácil acceso.

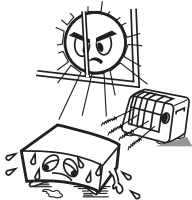
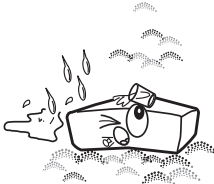
**WAARSCHUWING:**  
Om de voeding van dit product volledig te onderbreken moet de stekker uit het stopcontact worden getrokken.  
De netstekker wordt gebruikt om de stroomtoevoer naar het toestel volledig te onderbreken en moet voor de gebruiker gemakkelijk bereikbaar zijn.

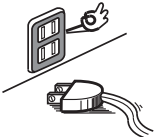
**FÖRSIKTIHETSMÅTT:**  
Koppla loss stickproppen från eluttaget för att helt skilja produkten från nätet.  
Stickproppen används för att helt bryta strömförsörjningen till apparaten, och den måste vara lättillgänglig för användaren.

NOTE ON USE / HINWEISE ZUM GEBRAUCH / OBSERVATIONS RELATIVES A L'UTILISATION / NOTE SULL'USO / NOTAS SOBRE EL USO / ALVORENSTE GEBRUIKEN / OBSERVERA ANGÅENDE ANVÄNDNINGEN

 <ul style="list-style-type: none"> <li>• Avoid high temperatures. Allow for sufficient heat dispersion when installed in a rack.</li> <li>• Vermeiden Sie hohe Temperaturen. Beachten Sie, dass eine ausreichende Belüftung gewährleistet wird, wenn das Gerät auf ein Regal gestellt wird.</li> <li>• Eviter des températures élevées. Tenir compte d'une dispersion de chaleur suffisante lors de l'installation sur une étagère.</li> <li>• Evitate di esporre l'unità a temperature elevate. Assicuratevi che vi sia un'adeguata dispersione del calore quando installate l'unità in un mobile per componenti audio.</li> <li>• Evite altas temperaturas. Permite la suficiente dispersión del calor cuando está instalado en la consola.</li> <li>• Vermijd hoge temperaturen. Zorg er bij installatie in een audiorack voor, dat de door het toestel geproduceerde warmte goed kan worden afgevoerd.</li> <li>• Undvik höga temperaturer. Se till att det finns möjlighet till god värmeavledning vid montering i ett rack.</li> </ul>	 <ul style="list-style-type: none"> <li>• Keep the unit free from moisture, water, and dust.</li> <li>• Halten Sie das Gerät von Feuchtigkeit, Wasser und Staub fern.</li> <li>• Protéger l'appareil contre l'humidité, l'eau et la poussière.</li> <li>• Tenete l'unità lontana dall'umidità, dall'acqua e dalla polvere.</li> <li>• Mantenga el equipo libre de humedad, agua y polvo.</li> <li>• Laat geen vochtigheid, water of stof in het apparaat binnendringen.</li> <li>• Utsätt inte apparaten för fukt, vatten och damm.</li> </ul>	 <ul style="list-style-type: none"> <li>• Do not let foreign objects into the unit.</li> <li>• Lassen Sie keine fremden Gegenstände in das Gerät kommen.</li> <li>• Ne pas laisser des objets étrangers dans l'appareil.</li> <li>• Non inserite corpi estranei all'interno dell'unità.</li> <li>• No deje objetos extraños dentro del equipo.</li> <li>• Laat geen vreemde voorwerpen in dit apparaat vallen.</li> <li>• Se till att främmande föremål inte tränger in i apparaten.</li> </ul>	<p><b>CAUTION:</b></p> <ul style="list-style-type: none"> <li>• The ventilation should not be impeded by covering the ventilation openings with items, such as newspapers, tablecloths, curtains, etc.</li> <li>• No naked flame sources, such as lighted candles, should be placed on the unit.</li> <li>• Observe and follow local regulations regarding battery disposal.</li> <li>• Do not expose the unit to dripping or splashing fluids.</li> <li>• Do not place objects filled with liquids, such as vases, on the unit.</li> </ul> <p><b>ACHTUNG:</b></p> <ul style="list-style-type: none"> <li>• Die Belüftung sollte auf keinen Fall durch das Abdecken der Belüftungsöffnungen durch Gegenstände wie beispielsweise Zeitungen, Tischtücher, Vorhänge o. Ä. behindert werden.</li> <li>• Auf dem Gerät sollten keinerlei direkte Feuerquellen wie beispielsweise angezündete Kerzen aufgestellt werden.</li> <li>• Bitte beachten Sie bei der Entsorgung der Batterien die örtlich geltenden Umweltbestimmungen.</li> <li>• Das Gerät sollte keiner tropfenden oder spritzenden Flüssigkeit ausgesetzt werden.</li> <li>• Auf dem Gerät sollten keine mit Flüssigkeit gefüllten Behälter wie beispielsweise Vasen aufgestellt werden.</li> </ul>
 <ul style="list-style-type: none"> <li>• Handle the power cord carefully. Hold the plug when unplugging the cord.</li> <li>• Gehen Sie vorsichtig mit dem Netzkabel um. Halten Sie das Kabel am Stecker, wenn Sie den Stecker herausziehen.</li> <li>• Manipuler le cordon d'alimentation avec précaution. Tenir la prise lors du débranchement du cordon.</li> <li>• Maneggiare il cavo di alimentazione con attenzione. Tenete ferma la spina quando scollegate il cavo dalla presa.</li> <li>• Maneje el cordón de energía con cuidado. Sostenga el enchufe cuando desconecte el cordón de energía.</li> <li>• Hanteer het netsnoer voorzichtig. Houd het snoer bij de stekker vast wanneer deze moet worden aan- of losgekoppeld.</li> <li>• Hantera nätkablen varsamt. Håll i kablenn när den kopplas från el-uttaget.</li> </ul>	 <ul style="list-style-type: none"> <li>• Unplug the power cord when not using the unit for long periods of time.</li> <li>• Wenn das Gerät längere Zeit nicht verwendet werden soll, trennen Sie das Netzkabel vom Netzstecker.</li> <li>• Débrancher le cordon d'alimentation lorsque l'appareil n'est pas utilisé pendant de longues périodes.</li> <li>• Scollegate il cavo di alimentazione quando prevedete di non utilizzare l'unità per un lungo periodo di tempo.</li> <li>• Desconecte el cordón de energía cuando no utilice el equipo por mucho tiempo.</li> <li>• Neem altijd het netsnoer uit het stopkontakt wanneer het apparaat gedurende een lange periode niet wordt gebruikt.</li> <li>• Koppla loss nätkablen om apparaten inte kommer att användas i lång tid.</li> </ul>	 <ul style="list-style-type: none"> <li>• Do not let insecticides, benzene, and thinner come in contact with the unit.</li> <li>• Lassen Sie das Gerät nicht mit Insektiziden, Benzin oder Verdünnungsmitteln in Berührung kommen.</li> <li>• Ne pas mettre en contact des insecticides, du benzène et un diluant avec l'appareil.</li> <li>• Assicuratevi che l'unità non entri in contatto con insetticidi, benzolo o solventi.</li> <li>• No permita el contacto de insecticidas, gasolina y diluyentes con el equipo.</li> <li>• Voorkom dat insecticiden, benzeen of verfverdunder met dit toestel in contact komen.</li> <li>• Se till att inte insektsmedel på spraybruk, bensen och thinner kommer i kontakt med apparatens hölje.</li> </ul>	<p><b>ATTENTION:</b></p> <ul style="list-style-type: none"> <li>• La ventilation ne doit pas être gênée en recouvrant les ouvertures de la ventilation avec des objets tels que journaux, rideaux, tissus, etc.</li> <li>• Aucune flamme nue, par exemple une bougie, ne doit être placée sur l'appareil.</li> <li>• Veillez à respecter les lois en vigueur lorsque vous jetez les piles usagées.</li> <li>• L'appareil ne doit pas être exposé à l'eau ou à l'humidité.</li> <li>• Ne pas poser d'objet contenant du liquide, par exemple un vase, sur l'appareil.</li> </ul> <p><b>ATTENZIONE:</b></p> <ul style="list-style-type: none"> <li>• Le aperture di ventilazione non devono essere ostruite coprendole con oggetti, quali giornali, tovaglie, tende e così via.</li> <li>• Non posizionate sull'unità fiamme libere, come ad esempio candele accese.</li> <li>• Prestate attenzione agli aspetti legati alla tutela dell'ambiente nello smaltimento delle batterie.</li> <li>• L'apparecchiatura non deve essere esposta a gocciolii o spruzzi.</li> <li>• Non posizionate sull'unità alcun oggetto contenente liquidi, come ad esempio i vasi.</li> </ul> <p><b>PRECAUCIÓN:</b></p> <ul style="list-style-type: none"> <li>• La ventilación no debe quedar obstruida por haberse cubierto las aperturas con objetos como periódicos, manteles, cortinas, etc.</li> <li>• No debe colocarse sobre el aparato ninguna fuente inflamable sin protección, como velas encendidas.</li> <li>• A la hora de deshacerse de las pilas, respete la normativa para el cuidado del medio ambiente.</li> <li>• No exponer el aparato al goteo o salpicaduras cuando se utilice.</li> <li>• No colocar sobre el aparato objetos llenos de líquido, como jarras.</li> </ul>
	 <p>* (For apparatuses with ventilation holes)</p> <ul style="list-style-type: none"> <li>• Do not obstruct the ventilation holes.</li> <li>• Decken Sie den Lüftungsbereich nicht ab.</li> <li>• Ne pas obstruer les trous d'aération.</li> <li>• Non coprite i fori di ventilazione.</li> <li>• No obstruya los orificios de ventilación.</li> <li>• De ventilatieopeningen mogen niet worden geblokkeerd.</li> <li>• Täpp inte till ventilationsöppningarna.</li> </ul>	 <ul style="list-style-type: none"> <li>• Never disassemble or modify the unit in any way.</li> <li>• Versuchen Sie niemals das Gerät auseinander zu nehmen oder zu verändern.</li> <li>• Ne jamais démonter ou modifier l'appareil d'une manière ou d'une autre.</li> <li>• Non smontate né modificate l'unità in alcun modo.</li> <li>• Nunca desarme o modifique el equipo de ninguna manera.</li> <li>• Dit toestel mag niet gedemonteerd of aangepast worden.</li> <li>• Ta inte isär apparaten och försök inte bygga om den.</li> </ul>	<p><b>WAARSCHUWING:</b></p> <ul style="list-style-type: none"> <li>• De ventilatie mag niet worden belemmerd door de ventilatieopeningen af te dekken met bijvoorbeeld kranten, een tafelkleed, gordijnen, enz.</li> <li>• Plaats geen open vlammen, bijvoorbeeld een brandende kaars, op het apparaat.</li> <li>• Houd u steeds aan de milieuvorschriften wanneer u gebruikte batterijen wegdoet.</li> <li>• Stel het apparaat niet bloot aan druppels of spatten.</li> <li>• Plaats geen voorwerpen gevuld met water, bijvoorbeeld een vaas, op het apparaat.</li> </ul> <p><b>OBSERVERA:</b></p> <ul style="list-style-type: none"> <li>• Ventilationen bör inte förhindras genom att täcka för ventilationsöppningarna med föremål såsom tidningar, bordsdukar, gardiner osv.</li> <li>• Inga blottade brandkällor, såsom tända ljus, får placeras på apparaten.</li> <li>• Tänk på miljöaspekterna när du bortskaffar batterier.</li> <li>• Apparaten får inte utsättas för vätska.</li> <li>• Placera inte föremål fyllda med vätska, t.ex. vasar, på apparaten.</li> </ul>

**A NOTE ABOUT RECYCLING:**

This product's packaging materials are recyclable and can be reused. Please dispose of any materials in accordance with the local recycling regulations.

When discarding the unit, comply with local rules or regulations.

Batteries should never be thrown away or incinerated but disposed of in accordance with the local regulations concerning battery disposal.

This product and the supplied accessories, excluding the batteries, constitute the applicable product according to the WEEE directive.



**HINWEIS ZUM RECYCLING:**

Das Verpackungsmaterial dieses Produktes ist zum Recyceln geeignet und kann wieder verwendet werden. Bitte entsorgen Sie alle Materialien entsprechend der örtlichen Recycling-Vorschriften.

Beachten Sie bei der Entsorgung des Gerätes die örtlichen Vorschriften und Bestimmungen.

Die Batterien dürfen nicht in den Hausmüll geworfen oder verbrannt werden; bitte entsorgen Sie die Batterien gemäß der örtlichen Vorschriften.

Dieses Produkt und das im Lieferumfang enthaltene Zubehör (mit Ausnahme der Batterien!) entsprechen der WEEE-Direktive.

**UNE REMARQUE CONCERNANT LE RECYCLAGE:**

Les matériaux d'emballage de ce produit sont recyclables et peuvent être réutilisés. Veuillez disposer des matériaux conformément aux lois sur le recyclage en vigueur.

Lorsque vous mettez cet appareil au rebut, respectez les lois ou réglementations en vigueur.

Les piles ne doivent jamais être jetées ou incinérées, mais mises au rebut conformément aux lois en vigueur sur la mise au rebut des piles.

Ce produit et les accessoires inclus, à l'exception des piles, sont des produits conformes à la directive DEEE.

**NOTA RELATIVA AL RICICLAGGIO:**

I materiali di imballaggio di questo prodotto sono riutilizzabili e riciclabili. Smaltire i materiali conformemente alle normative locali sul riciclaggio.

Per lo smaltimento dell'unità, osservare le normative o le leggi locali in vigore.

Non gettare le batterie, né incenerirle, ma smaltirle conformemente alla normativa locale sui rifiuti chimici.

Questo prodotto e gli accessori inclusi nell'imballaggio sono applicabili alla direttiva RAEE, ad eccezione delle batterie.

**ACERCA DEL RECICLAJE:**

Los materiales de embalaje de este producto son reciclables y se pueden volver a utilizar. Disponga de estos materiales siguiendo los reglamentos de reciclaje de su localidad.

Cuando se deshaga de la unidad, cumpla con las reglas o reglamentos locales.

Las pilas nunca deberán tirarse ni incinerarse. Deberá disponer de ellas siguiendo los reglamentos de su localidad relacionados con los desperdicios químicos.

Este producto junto con los accesorios empaquetados es el producto aplicable a la directiva RAEE excepto pilas.

**EEN AANTEKENING MET BETREKKING TOT DE RECYCLING:**

Het inpakmateriaal van dit product is recycleerbaar en kan opnieuw gebruikt worden. Er wordt verzocht om zich van elk afvalmateriaal te ontdoen volgens de plaatselijke voorschriften.

Volg voor het wegdoen van de speler de voorschriften voor de verwijdering van wit- en bruingoed op.

Batterijen mogen nooit worden weggegooid of verbrand, maar moeten volgens de plaatselijke voorschriften betreffende chemisch afval worden verwijderd.

Op dit product en de meegeleverde accessoires, m.u.v. de batterijen is de richtlijn voor afgedankte elektrische en elektronische apparaten (WEEE) van toepassing.

**OBSERVERA ANGÅENDE ÅTERTVINNING:**

Produktens emballage är återvinningsbart och kan återanvändas. Kassera det enligt lokala återvinningsbestämmelser.

När du kasserar enheten ska du göra det i överensstämmelse med lokala regler och bestämmelser.

Batterier får absolut inte kastas i soporna eller brännas. Kassera dem enligt lokala bestämmelser för kemiskt avfall.

Denna apparat och de tillbehör som levereras med den uppfyller gällande WEEE-direktiv, med undantag av batterierna.

**1. IMPORTANT NOTICE: DO NOT MODIFY THIS PRODUCT**

This product, when installed as indicated in the instructions contained in this manual, meets R&TTE directive requirements. Modification of the product could result in hazardous Radio and EMC radiation.

**2. CAUTION**

- Separation distance of at least 20 cm must be maintained between the antenna of this product and all persons.
- This product and its antenna must not be co-located or operating in conjunction with any other antenna or transmitter.

**1. WICHTIGER HINWEIS: NEHMEN SIE KEINE VERÄNDERUNGEN AN DIESEM PRODUKT VOR**

Wenn dieses Produkt entsprechend dieser Bedienungsanleitung aufgebaut wird, entspricht es den Anforderungen der R&TTE-Richtlinie. Veränderungen am Produkt können zu gefährlicher Funk- und EMV-Strahlung führen.

**2. VORSICHT**

- Zwischen der Antenne dieses Produkts und Personen muss ein Schutzabstand von 20 cm eingehalten werden.
- Dieses Produkt und seine Antenne dürfen nicht neben anderen Antennen oder Sendern aufgestellt oder zusammen mit ihnen verwendet werden.

**1. MISE EN GARDE IMPORTANTE : NE JAMAIS MODIFIER CE PRODUIT**

Si toutes les consignes indiquées dans ce mode ont été respectées pendant son installation, ce produit est conforme aux directives R&TTE. Toute modification du produit risquerait alors de générer des radiations radio et EMC dangereuses.

**2. ATTENTION**

- L'antenne de l'appareil devra être située à une distance de 20 cm au moins des personnes.
- Ce produit ainsi que son antenne ne devront en aucun cas être utilisés à proximité d'une autre antenne ou transmetteur.

**1. AVVERTENZA IMPORTANTE: NON MODIFICARE QUESTO PRODOTTO**

Se installato come indicato nelle istruzioni del presente manuale, questo prodotto soddisfa i requisiti della direttiva R&TTE. Eventuali modifiche apportate al prodotto potrebbero causare pericolose radiazioni radio ed EMC.

**2. ATTENZIONE**

- È necessario mantenere una distanza minima di 20 cm tra l'antenna di questo prodotto e le persone.
- Questo prodotto e la relativa antenna non devono essere posizionati in prossimità di altre antenne o trasmettitori e non devono essere utilizzati congiuntamente a questi ultimi.

**1. NOTA IMPORTANTE: NO MODIFIQUE ESTE PRODUCTO**

Este producto, si es instalado de acuerdo con las instrucciones contenidas en este manual, cumple los requisitos de la directiva R&TTE. La modificación del producto puede producir radiación de Radio y EMC peligrosa.

**2. PRECAUCIÓN**

- Se debe mantener una separación de al menos 20 cm entre la antena del producto y las personas.
- Este producto y su antena no debe instalarse ni utilizarse conjuntamente con otra antena o transmisor.

**1. BELANGRIJKE MEDEDELING: BRENG AAN DIT PRODUCT GEEN AANPASSINGEN AAN**

Dit product, indien geïnstalleerd volgens de aanwijzingen in deze gebruiksaanwijzing, voldoet aan de vereisten van de R&TTE-richtlijn. Aanpassing van dit product kan gevaarlijke radio- en EMC-straling tot gevolg hebben.

**2. LET OP**

- Houd tussen antenne en personen altijd een afstand van tenminste 20 cm aan.
- Dit product en zijn antenne mogen niet in de buurt van een andere antenne of zender worden geplaatst of in combinatie daarmee worden gebruikt.

**1. VIKTIGT: APPARATEN FÅR INTE MODIFIERAS**

Under förutsättning att apparaten installeras enligt anvisningarna i denna bruksanvisning, uppfyller denna kraven i R&TTE-direktivet. Ev. modifiering av apparaten kan resultera i farlig radio- och elektromagnetisk strålning.

**2. FÖRSIKTIG**

- Se till att det finns ett avstånd på minst 20 cm mellan apparatens antenn och personer i omgivningen.
- Apparaten och dess antenn får inte placeras eller användas i närheten av andra antenner eller sändare.

# Contents

## Getting Started

<b>Accessories</b> .....	2
<b>About the CD-ROM (Owner's Manual)</b> .....	3
<b>Cautions on Handling</b> .....	3
<b>Cautions on Installation</b> .....	3
<b>About the Remote Control Unit</b> .....	3
Inserting the Batteries.....	3, 4
Operating Range of the Remote Control Unit.....	4
<b>Part Names and Functions</b> .....	4
Front Panel.....	4, 5
Display.....	5
Rear Panel.....	6
Remote Control Unit.....	7

## Connections

<b>Preparations</b> .....	8
Cables Used for Connections.....	8
Video Conversion Function.....	9
Speaker Layout.....	10
<b>Connecting to the Power Amp</b> .....	10
POA-A1HD Connection and Operation.....	10 ~ 12
<b>Connecting Equipment with HDMI connectors</b> .....	12, 13
<b>Connecting the Monitor</b> .....	13
<b>Connecting the Playback Components</b> .....	13
DVD Player.....	13
Record Player.....	14
CD Player.....	14
iPod®.....	14
TV/CABLE Tuner.....	15
Satellite Receiver.....	15
<b>Connecting the Recording Components</b> .....	16
Digital Video Recorder.....	16
Video Cassette Recorder.....	17
CD Recorder / MD Recorder / Tape Deck.....	17
<b>Connections to Other Devices</b> .....	18
Components Equipped with a DENON LINK connector.....	18
Video Camera / Game Console.....	18
Component with Multi-channel Output connectors.....	18
USB Port.....	19
Network Audio.....	20
Multi Zone.....	21
External Controller.....	22
<b>Connecting the Power Cord</b> .....	22
<b>Once Connections are Completed</b> .....	22

## GUI Menu Operations

<b>Example of the Display of the GUI Mark at a Title</b> .....	23
<b>Example of Display of Default Values</b> .....	23
<b>Examples of GUI Screen Displays</b> .....	23
Example: Browse Menu (Top Menu).....	23
Example: Menus with Illustrations (Auto Setup).....	23
Cursor Position Display.....	23
<b>Operations</b> .....	23
<b>GUI Menu Map</b> .....	24

## Auto Setup

<b>Preparations</b> .....	25
<b>Auto Setup</b> .....	25
<b>1</b> Auto Setup.....	25, 26
Error Messages.....	27
<b>2</b> Option.....	27
<b>3</b> Parameter Check.....	27

## Manual Setup

<b>Speaker Setup</b> .....	28
<b>1</b> Speaker Configuration.....	28
<b>2</b> Subwoofer Setup.....	28
<b>3</b> Distance.....	29
<b>4</b> Channel Level.....	29
<b>5</b> Crossover Frequency.....	29, 30
<b>6</b> THX Audio Setup.....	30
<b>7</b> Surround Speaker.....	30
<b>HDMI Setup</b> .....	31
<b>1</b> Color Space.....	31
<b>2</b> RGB Range.....	31
<b>3</b> Auto Lip Sync.....	31
<b>4</b> Audio.....	31
<b>5</b> Monitor Out.....	31
<b>6</b> HDMI Control.....	31
<b>Audio Setup</b> .....	32
<b>1</b> EXT. IN Setup.....	32
<b>2</b> 2ch Direct/Stereo.....	32
<b>3</b> Downmix Option.....	33
<b>4</b> Auto Surround Mode.....	33
<b>5</b> Manual EQ.....	33
<b>Network Setup</b> .....	34
<b>1</b> Network Setup.....	34, 35
<b>2</b> Other.....	36
<b>3</b> Network Information.....	36
<b>Zone Setup</b> .....	36
<b>1</b> ZONE2.....	36, 37
<b>2</b> ZONE3.....	36, 37
<b>3</b> OSD.....	37

<b>Option Setup</b> .....	37
<b>1</b> Pre-out Assign.....	38
<b>2</b> XLR Out Polarity.....	38
<b>3</b> POA Setting.....	38, 39
<b>4</b> Volume Control.....	39
<b>5</b> Source Delete.....	39
<b>6</b> GUI.....	39
<b>7</b> Quick Select Name.....	39
<b>8</b> Trigger Out 1.....	40
<b>9</b> Trigger Out 2.....	40
<b>10</b> Trigger Out 3.....	40
<b>11</b> Trigger Out 4.....	40
<b>12</b> Transducer Setup.....	40
<b>13</b> Digital Out.....	40
<b>14</b> Remote ID.....	40
<b>15</b> 2Way Remote.....	40
<b>16</b> Dimmer.....	41
<b>17</b> Setup Lock.....	41
<b>18</b> Maintenance Mode.....	41
<b>19</b> Firmware Update.....	41
<b>20</b> Add New Feature.....	41
<b>Language</b> .....	42

## Source Select

<b>Input Source Selection</b> .....	42
<b>Settings Related to Playing Input Sources</b> .....	43
<b>1</b> Play.....	43
<b>2</b> Playback Mode (iPod).....	43
<b>3</b> Assign.....	43, 44
<b>4</b> Video.....	44, 45
<b>5</b> Input Mode.....	45
<b>6</b> Rename.....	45
<b>7</b> Source Level.....	45
<b>8</b> Input Att.....	45
<b>9</b> Playback Mode.....	46
<b>10</b> Still Picture.....	46

## Surround Mode

<b>HOME THX CINEMA</b> .....	46
Surround Playback of 2-channel Sources.....	46
Playing Multi-channel Sources (Dolby Digital, DTS, etc.).....	46
<b>Standard Playback</b> .....	47
Surround Playback of 2-channel Sources.....	47
Playing Multi-channel Sources (Dolby Digital, DTS, etc.).....	47
Dolby Headphone.....	47
<b>DSP Simulation Playback</b> .....	47, 48
<b>Stereo Playback</b> .....	48
<b>Direct Playback</b> .....	48
Playback in the PURE DIRECT Mode.....	48

Parameter	
<b>Audio</b>	48
1 Surround Parameters	48 ~ 50
2 Tone	50, 51
3 Room EQ	51
4 Dynamic EQ	51
5 RESTORER	51
6 Night Mode	51
7 Audio Delay	52
<b>Picture Adjust</b>	52
1 Contrast	52
2 Brightness	52
3 Chroma Level	52
4 Hue	52
5 DNR	52
6 Enhancer	52
7 Sharpness	52

Information	
<b>Status</b>	52
1 MAIN ZONE	52
2 ZONE2/3/4	52
<b>Audio Input Signal</b>	53
<b>HDMI Information</b>	53
1 Signal Information	53
2 Monitor1	53
3 Monitor2	53
<b>Auto Surround Mode</b>	53
<b>Quick Select</b>	53
<b>Preset Station</b>	53

Playback	
<b>Preparations</b>	54
Turning the Power On	54
Operations During Playback	54
<b>Playing Video and Audio Equipment</b>	54
Basic Operation	54
<b>iPod® Playback</b>	55
Basic Operation	55
Listening to Music	55
Viewing Still Pictures or Videos on the iPod	56
<b>Playing Network Audio ,USB Memory Devices</b>	56, 57
Basic Operation	58
Listening to Internet Radio	59
Playing Files Stored on a Computer	60
Playing Files Stored on USB Memory Devices	60, 61
Operating the AVP-A1HD Using a Browser (Web control)	61

Other Operations and Functions	
<b>Other Operations</b>	62
Playing Super Audio CD	62
Recording on an External Device (REC OUT mode)	62, 63
<b>Convenient Functions</b>	63
HDMI Control Function	63, 64
Channel Level	65
Fader Function	65
Quick Select Function	65
Personal Memory Plus Function	65
Last Function Memory	65
Backup Memory	65
Resetting the Microprocessor	65

Remote Control Unit Operations	
<b>Main Remote Control Unit</b>	66
Operating DENON Audio Components	66
Presetting	66
Operating Preset Components	66 ~ 68
Setting the Remote ID	69
Learning Function	69
System Call Function	70
Punch Through Function	70
Setting the Time the Backlight Stays Lit	71
Adjusting the Backlight's Brightness	71
Resetting the Main Remote Control Unit	71
<b>Sub Remote Control Unit Operations</b>	72, 73
Switching Zones	74
Setting the Zone for Which the Sub Remote Control Unit is Used (ZONE SELECT LOCK Mode)	74
Setting the Remote ID	74
Resetting the Settings	74

Multi-Zone Connections and Operations	
<b>Multi-Zone Connections</b>	75
<b>Multi-Zone Operations</b>	76
Turning the Power On and Off	76
Selecting the Input Source	76
Adjusting the Volume	76
Turning off the Sound Temporarily	76

Other Information	
	77 ~ 91

Troubleshooting	
	92 ~ 95

Specifications	
	95, 96

List of preset codes	
	End of this manual

# Getting Started

Thank you for purchasing this DENON product. To ensure proper operation, please read this owner's manual carefully before using the product.

After reading them, be sure to keep them for future reference.

## Accessories

Check that the following parts are supplied with the product.

- |   |   |
|---|---|
| ① Owner's manual                                | 1 |
| ② CD-ROM (Owner's manual)                       | 1 |
| ③ Service station list                          | 1 |
| ④ Power cord (Cord length: Approx. 1.5 m)       | 1 |
| ⑤ Main remote control (RC-1067)                 | 1 |
| ⑥ LR6/AA batteries (for RC-1067)                | 2 |
| ⑦ Sub remote control (RC-1070)                  | 1 |
| ⑧ R03/AAA batteries (for RC-1070)               | 2 |
| ⑨ Rod antenna for wireless LAN connection       | 1 |
| ⑩ Setup microphone (Cord length: Approx. 7.6 m) | 1 |

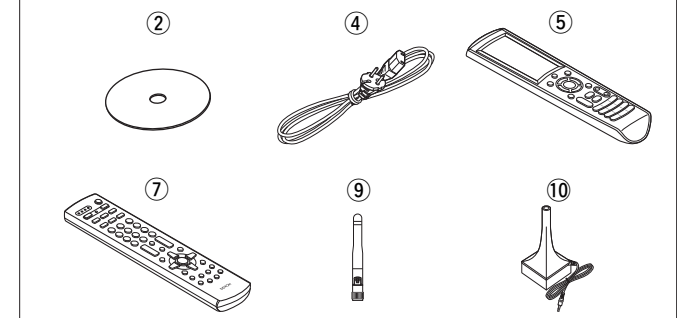

## About the CD-ROM (Owner's Manual)

### ENGLISH

Open the file "AVPA1HD\_ENGLISH.pdf"

 Adobe Acrobat Reader® 5.0 or later is required to view the text.

### DEUTSCH

Öffnen Sie die Datei "AVPA1HD\_DEUTSCH.pdf"

 Adobe Acrobat Reader 5.0® oder neuer ist für das Lesen des Textes erforderlich.

### FRANCAIS

Ouvrez le fichier "AVPA1HD\_FRANCAIS.pdf"

 Adobe Acrobat Reader® 5.0 ou ultérieur est nécessaire pour lire le texte.

### ITALIANO

Aprire il file "AVPA1HD\_ITALIANO.pdf"

 È necessario disporre di Adobe Acrobat Reader 5.0® o versione successiva per visualizzare il testo.

### ESPAÑOL

Abra el archivo "AVPA1HD\_ESPANOL.pdf"

 Se necesita la versión del Adobe Acrobat Reader® 5.0 o una superior para ver el texto.

### NEDERLANDS

Open het bestand "AVPA1HD\_NEDERLANDS.pdf"

 Om de tekst te bekijken, is Adobe Acrobat Reader® 5.0 of hoger vereist.

### SVENSKA

Öppna filen "AVPA1HD\_SVENSKA.pdf"

 Adobe Acrobat Reader® 5.0 eller senare behövs för att visa texten.

## Cautions on Handling

### • Before turning the power switch on

Check once again that all connections are correct and that there are no problems with the connection cables.

• Power is supplied to some of the circuitry even when the unit is set to the standby mode. When traveling or leaving home for long periods of time, be sure to unplug the power cord from the power outlet.

### • About condensation

If there is a major difference in temperature between the inside of the unit and the surroundings, condensation (dew) may form on the operating parts inside the unit, causing the unit not to operate properly.

If this happens, let the unit sit for an hour or two with the power turned off and wait until there is little difference in temperature before using the unit.

### • Cautions on using mobile phones

Using a mobile phone near this unit may result in noise. If so, move the mobile phone away from this unit when it is in use.

### • Moving the unit

Turn off the power and unplug the power cord from the power outlet.

Next, disconnect the connection cables to other system units before moving the unit.

• Note that the illustrations in these instructions may differ from the actual unit for explanation purposes.

• Light Emitting Diodes (LED) are used in the AVP-A1HD circuit. When powered on, a green light shows inside part of the AVP-A1HD, however this is not a fault.

## Cautions on Installation

### Note:

**For proper heat dispersal, do not install this unit in a confined space, such as a bookcase or similar enclosure.**

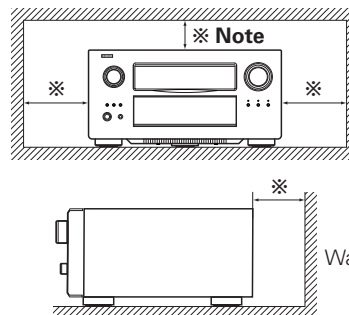

## About the Remote Control Unit

In addition to the AVP-A1HD, the included main remote control unit (RC-1067) can also be used to operate the equipment listed below.

- ① DENON system components
- ② Non-DENON system components
  - By setting the preset memory (👉 page 66 ~ 68)
  - By using the learn function (👉 page 69)

## Inserting the Batteries

- ① Lift the clasp and remove the rear lid.

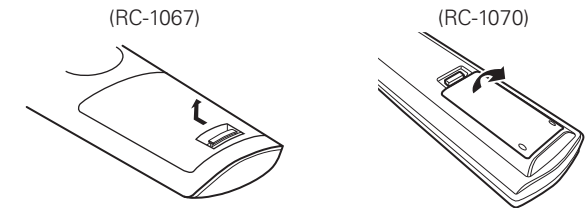

- ② Load the two batteries properly as indicated by the marks in the battery compartment.

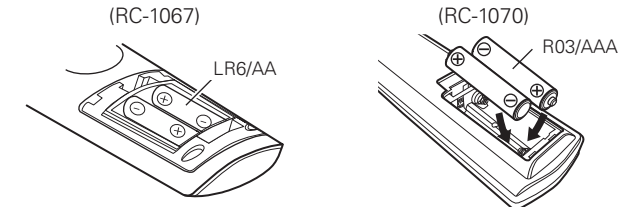

- ③ Put the rear cover back on.

**NOTE**

- Replace the batteries with new ones if the set does not operate even when the remote control unit is operated close to the unit.
- The supplied batteries are only for verifying operation.
- When inserting the batteries, be sure to do so in the proper direction, following the “⊕” and “⊖” marks in the battery compartment.
- To prevent damage or leakage of battery fluid:
  - Do not use a new battery together with an old one.
  - Do not use two different types of batteries.
  - Do not attempt to charge dry batteries.
  - Do not short-circuit, disassemble, heat or dispose of batteries in flames.
- If the battery fluid should leak, carefully wipe the fluid off the inside of the battery compartment and insert new batteries.
- Remove the batteries from the remote control unit if it will not be in use for long periods.
- When replacing the batteries, have the new batteries ready and insert them as quickly as possible.

**Operating Range of the Remote Control Unit**

Point the remote control unit at the remote sensor when operating it.

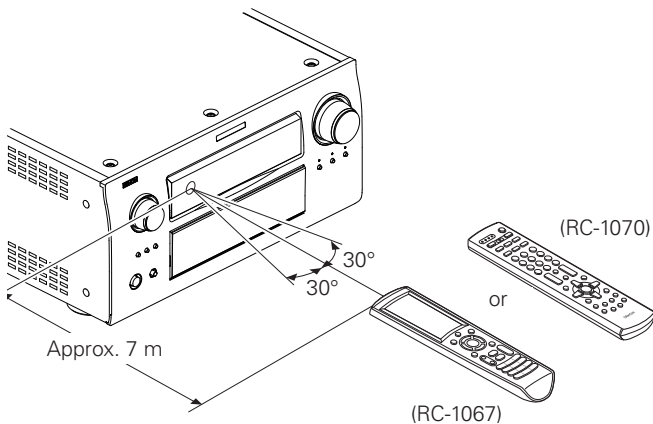

**NOTE**

The set may function improperly or the remote control unit may not operate if the remote control sensor is exposed to direct sunlight, strong artificial light from an inverter type fluorescent lamp or infrared light.

**Part Names and Functions**

For buttons not explained here, see the page indicated in parentheses ( ).

**Front Panel**

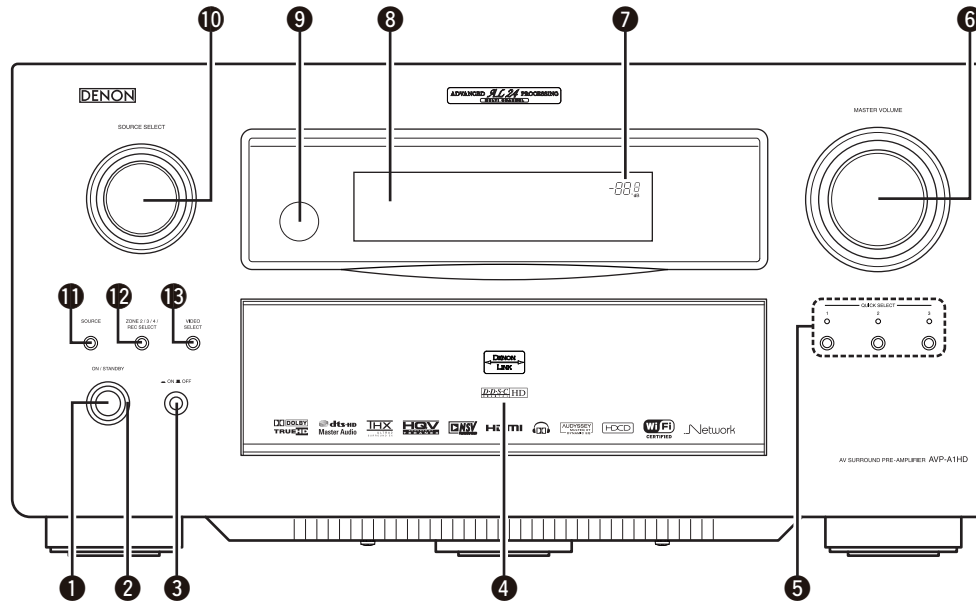

- |  |      |  |          |
|--|------|--|----------|
| <b>1</b> Power operation button (ON/STANDBY) ..... | (54) | <b>8</b> Display .....                         | (4)      |
| <b>2</b> Power indicator .....                     | (54) | <b>9</b> Remote control sensor .....           | (4)      |
| <b>3</b> Power switch (ON/OFF) .....               | (54) | <b>10</b> SOURCE SELECT knob .....             | (42)     |
| <b>4</b> Door .....                                | (54) | <b>11</b> SOURCE button .....                  | (42)     |
| <b>5</b> QUICK SELECT buttons / indicators .....   | (65) | <b>12</b> ZONE 2/3/4 / REC SELECT button ..... | (62, 76) |
| <b>6</b> MASTER VOLUME control knob .....          | (54) | <b>13</b> VIDEO SELECT button .....            | (44)     |
| <b>7</b> Master volume indicator .....             | (54) |  |          |



[With the door open]

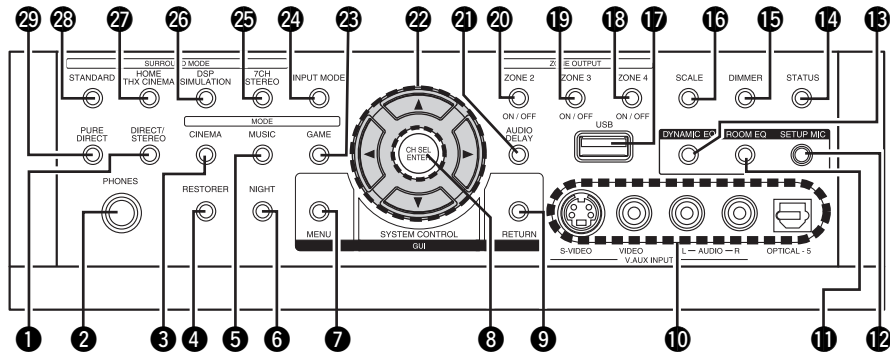

- 1 DIRECT/STEREO button ..... (48)
- 2 Headphones jack (PHONES) ..... (54, 63)
- 3 CINEMA button ..... (47)
- 4 RESTORER button ..... (51)
- 5 MUSIC button ..... (47)
- 6 NIGHT button ..... (51)
- 7 MENU button ..... (23)
- 8 CH SEL / ENTER button ..... (23, 65)
- 9 RETURN button ..... (23)
- 10 V.AUX INPUT connectors ..... (18)
- 11 ROOM EQ button ..... (51)
- 12 SETUP MIC jack ..... (25)
- 13 DYNAMIC EQ button ..... (51)
- 14 STATUS button ..... (53)
- 15 DIMMER button ..... (41)
- 16 SCALE button ..... (45)
- 17 USB port ..... (19)
- 18 ZONE4 ON/OFF button ..... (76)
- 19 ZONE3 ON/OFF button ..... (76)
- 20 ZONE2 ON/OFF button ..... (76)
- 21 AUDIO DELAY button ..... (52)
- 22 Cursor buttons (Δ ▽ ◀ ▶) ..... (23)
- 23 GAME button ..... (47)
- 24 INPUT MODE button ..... (45)
- 25 7CH STEREO button ..... (47)
- 26 DSP SIMULATION button ..... (48)
- 27 HOME THX CINEMA button ..... (46)
- 28 STANDARD button ..... (47)
- 29 PURE DIRECT button ..... (48)

Display

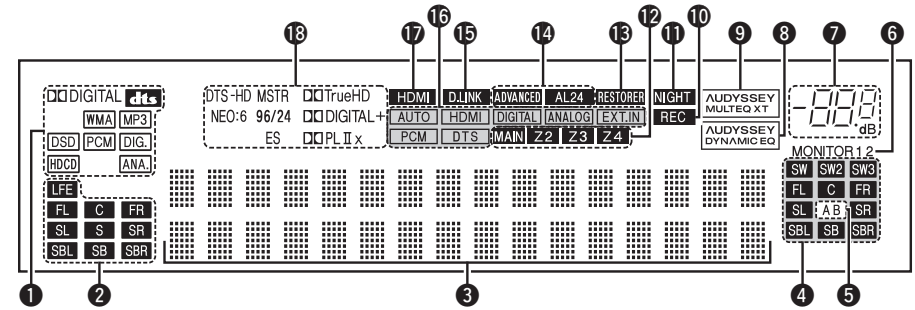

- 1 Input signal indicators  
These light when digital signals are input.
- 2 Input signal channel indicators  
These light when the night mode is selected.
- 3 Information display  
The input source name, surround mode, setting values and other information are displayed here.
- 4 Output signal channel indicators  
These light according to the settings of the surround A and B speakers.
- 5 Surround speaker indicators  
These light according to the HDMI monitor output setting. When set to "Auto (Dual)", the indicators light according to the connection status.
- 6 Monitor output indicators  
These light when the Dynamic EQ is selected.
- 7 Master volume indicator  
This lights when the room equalizer is selected.
- 8 AUDYSSEY DYNAMIC EQ indicator  
This lights when the REC OUT mode is selected.
- 9 AUDYSSEY MULTEQ XT indicator  
This lights when the room equalizer is selected.
- 10 Recording output source indicator  
This lights when the REC OUT mode is selected.
- 11 NIGHT indicator  
This lights when the night mode is selected.
- 12 Multi zone indicators  
These light when the power for the respective zone is turned on.
- 13 RESTORER indicator  
This lights when the RESTORER mode is selected.
- 14 ADVANCED AL24 indicator  
This lights when Advanced AL24 Processing is activated (see page 81).
- 15 D.LINK indicator  
This lights when playing using DENON LINK connections.
- 16 Input mode indicators  
This lights when playing using HDMI connections.
- 17 HDMI indicator  
This lights when playing using HDMI connections.
- 18 Decoder indicators  
These light when the respective decoders are operating.

Rear Panel

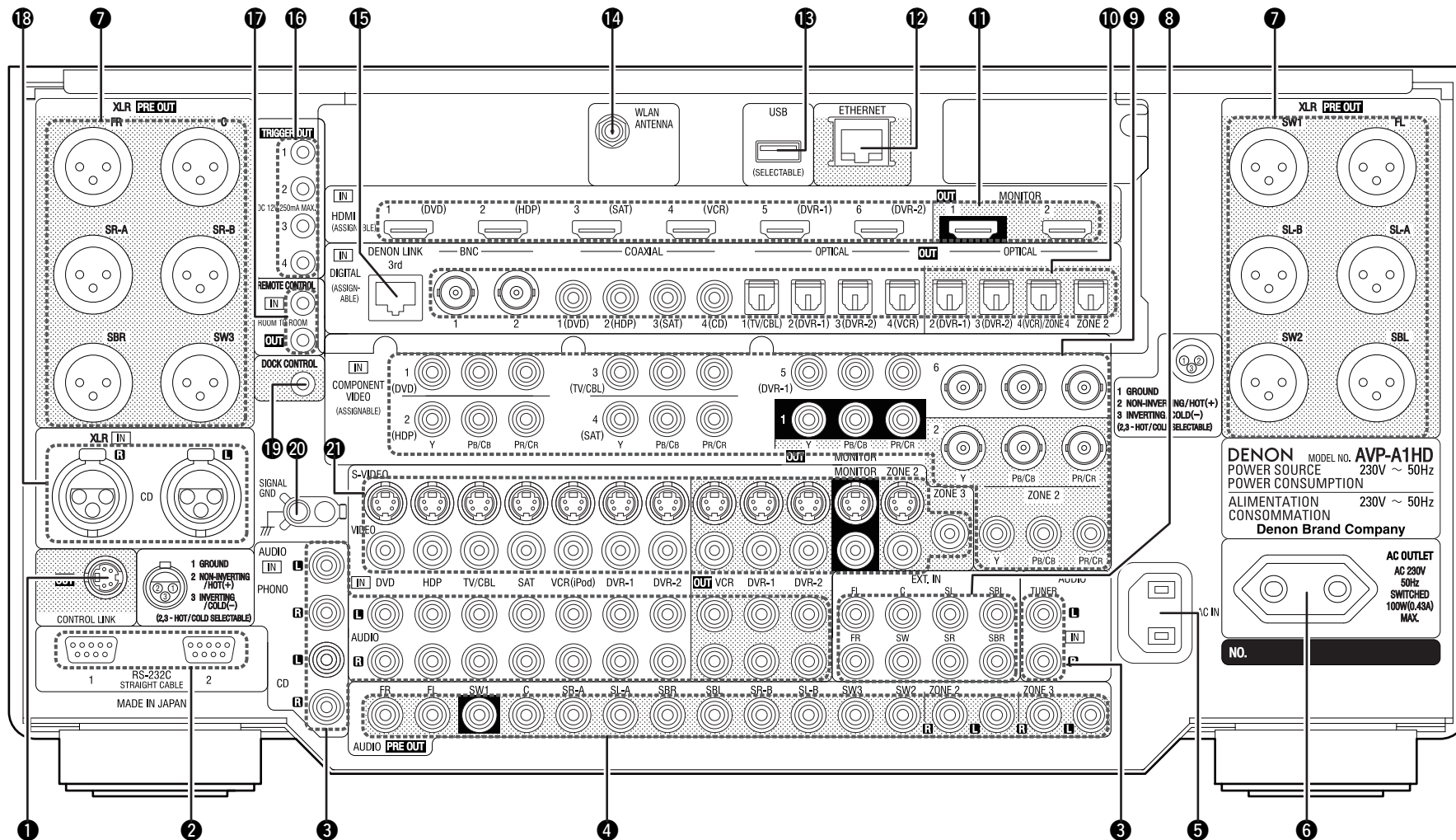

- ① CONTROL LINK connector.....(11)
- ② RS-232C connector.....(22)
- ③ Analog audio connectors (AUDIO).....(14)
- ④ RCA PRE OUT connectors.....(11, 21)
- ⑤ AC inlet (AC IN).....(22)
- ⑥ AC OUTLET.....(22)
- ⑦ XLR PRE OUT connectors.....(11)
- ⑧ EXT. IN connectors.....(18)
- ⑨ COMPONENT VIDEO connectors.....(13, 21)
- ⑩ Digital audio connectors (OPTICAL / COAXIAL / BNC).....(13, 21)
- ⑪ HDMI connectors.....(12)
- ⑫ ETHERNET connector.....(20)
- ⑬ USB port.....(19)
- ⑭ WLAN ANTENNA terminal.....(20)
- ⑮ DENON LINK connector.....(18)
- ⑯ TRIGGER OUT jacks.....(22)
- ⑰ REMOTE CONTROL jacks.....(21)
- ⑱ XLR audio connectors (CD).....(14)
- ⑲ DOCK CONTROL jack.....(14)
- ⑳ SIGNAL GND terminal.....(14)
- ㉑ VIDEO / S-VIDEO connectors.....(13)

Getting Started  
Connections  
Setup  
Playback  
Remote Control  
Multi-Zone  
Information  
Troubleshooting

Remote Control Unit

□ Main remote control unit (RC-1067)

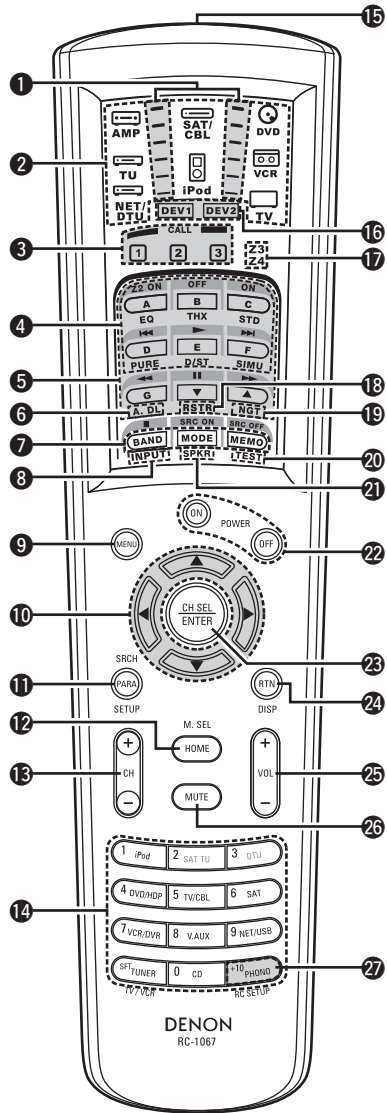

- 1 Signal transmission indicator ..... (66)
- 2 Mode select buttons ..... (66)
- 3 Quick select / System call buttons ..... (65, 70)
- 4 Surround mode buttons ..... (46 ~ 48)
- 5 System buttons ..... (67, 68)
- 6 Audio delay button (A. DL) ..... (52)
- 7 Tuner system buttons ..... (68)
- 8 Input mode button (INPUT) ..... (45)
- 9 MENU button ..... (23)
- 10 Cursor buttons (Δ▽◀▶) ..... (23)
- 11 Parameter / Search button (PARA / SRCH) ..... (48, 55)
- 12 Monitor select (M. SEL) / HOME button ..... (31, 66)
- 13 Channel buttons (CH) ..... (55, 67)
- 14 Input source select / Number buttons ..... (42, 54)
- 15 Remote control signal transmitter ..... (4)
- 16 Device select indicators (DEV1 / DEV2) ... (66)
- 17 ZONE3 / ZONE4 select indicators (Z3 / Z4) ..... (76)
- 18 RESTORER button (RSTR) ..... (51)
- 19 Night button (NGT) ..... (51)
- 20 Test tone button (TEST) ..... (29)
- 21 Surround speaker select button (SPKR) ... (30)
- 22 POWER buttons ..... (54)
- 23 Channel select (CH SEL) / ENTER button ..... (23, 65)
- 24 Return button (RTN) ..... (23)
- 25 Master volume control buttons (VOL) ..... (54)
- 26 Muting button (MUTE) ..... (54, 76)
- 27 Main remote control unit setup button (RC SETUP) ..... (66)



The time for which the backlight stays on can be changed (page 71 "Setting the Time the Backlight Stays Lit").

**NOTE**

The **SAT TU**, **DTU**, **ZONE2** mode **QUICK SELECT (1 ~ 3)**, **A. DL**, **RSTR**, **NGT**, **INPUT**, **SPKR**, **TEST** and surround mode buttons cannot be used.

□ Sub remote control unit (RC-1070)

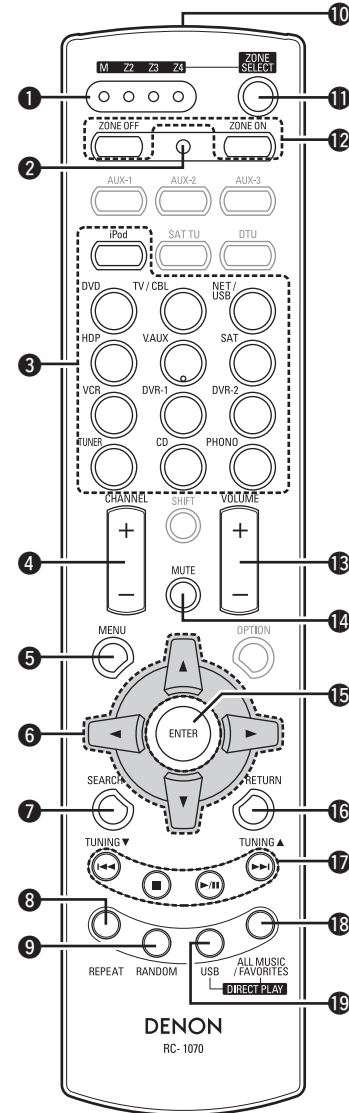

- 1 ZONE indicators ..... (74)
- 2 Advanced setup button ..... (74)
- 3 Input source select buttons ..... (42)
- 4 CHANNEL buttons ..... (55, 73)
- 5 MENU button ..... (23)
- 6 Cursor buttons (Δ▽◀▶) ..... (23)
- 7 SEARCH button ..... (55)
- 8 REPEAT button ..... (55)
- 9 RANDOM button ..... (55)
- 10 Remote control signal transmitter ..... (4)
- 11 ZONE SELECT button ..... (74)
- 12 Zone power on/off buttons (ZONE ON / ZONE OFF) ..... (76)
- 13 Master volume control buttons (VOLUME) ..... (54)
- 14 Muting button (MUTE) ..... (54, 76)
- 15 ENTER button ..... (23)
- 16 RETURN button ..... (23)
- 17 System buttons ..... (73)
- 18 ALL MUSIC/FAVORITES (DIRECT PLAY) button ..... (72)
- 19 USB (DIRECT PLAY) button ..... (72)

**NOTE**

The **AUX-1**, **AUX-2**, **AUX-3**, **SAT TU**, **DTU**, **SHIFT** and **OPTION** buttons cannot be used.

# Connections

Connections for all compatible audio and video signal formats are described in these operating instructions. Please select the types of connections suited for the equipment you are connecting. With some types of connections, certain settings must be made on the AVP-A1HD. For details, refer to the instructions for the respective connection items below.



















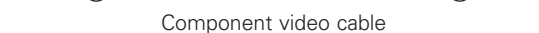

**NOTE**

- Do not plug in the power cord until all connections have been completed.
- When making connections, also refer to the operating instructions of the other components.
- Be sure to connect the left and right channels properly (left with left, right with right).
- Do not bundle power cords together with connection cables. Doing so can result in humming or noise.

## Preparations

### Cables Used for Connections

Select the cables according to the equipment being connected.

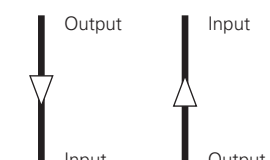
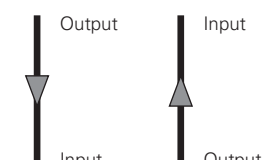
Audio cables	Video cables
<p><b>Coaxial digital connections</b></p> <p>(Orange)  Coaxial digital (75 Ω/ohms pin-plug) cable</p> <p><b>Optical digital connections</b></p> <p> Optical cable</p> <p><b>BNC digital connections</b></p> <p> BNC (75 Ω/ohms) cable</p> <p><b>Analog connections (XLR)</b></p> <p> Balanced cable</p> <p><b>Analog connections (stereo, RCA)</b></p> <p>(White)                        (Red)</p> <p style="text-align: center;">Stereo pin-plug cable</p> <p><b>Analog connections (monaural, for subwoofer)</b></p> <p>(Black)  Pin-plug cable</p> <p><b>DENON LINK connections</b></p> <p> DENON LINK cable</p> <p><b>Network connections (wired LAN)</b></p> <p> Ethernet cable</p>	<p><b>Component video connections</b></p> <p>(Green)   (Y)                      (Blue)  (Pb/Cb)                      (Red)  (Pr/CR)</p> <p style="text-align: center;">Component video cable</p> <p>(Green)   (Y)                      (Blue)  (Pb/Cb)                      (Red)  (Pr/CR)</p> <p style="text-align: center;">BNC (75 Ω/ohms) cable</p> <p><b>S-Video connections</b></p> <p> S-Video cable</p> <p><b>Video connections</b></p> <p>(Yellow)  </p> <p style="text-align: center;">75 Ω/ohms pin-plug video cable</p>
Audio and video cables	
<p><b>HDMI connections</b></p> <p> 19-pin HDMI cable</p>	
Signal direction	
<p>Audio signal: </p> <p>Video signal: </p>	

## Video Conversion Function

- This function automatically converts various formats of video signals input to the AVP-A1HD into the format used to output the video signals from the AVP-A1HD to a monitor.
- The AVP-A1HD's video input/output circuitry is compatible with the following four types of video signals:  
 Digital video signals: HDMI  
 Analog video signals: Component video, S-Video and Video

[Flow of video signals inside the AVP-A1HD]

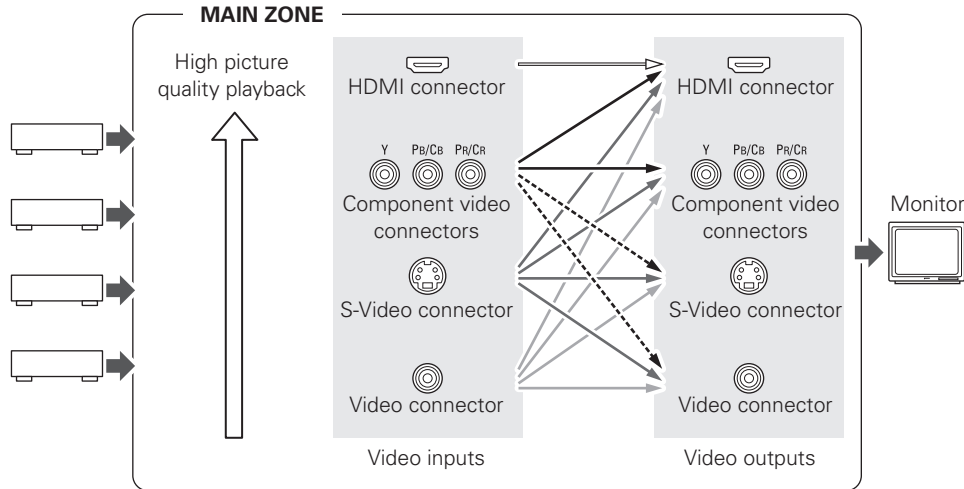

[Flow of video signals for ZONE2]

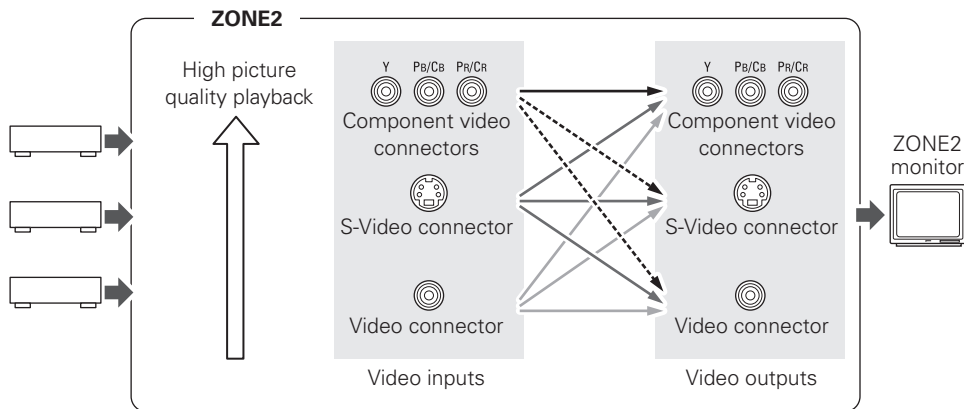

[Flow of video signals for ZONE3]

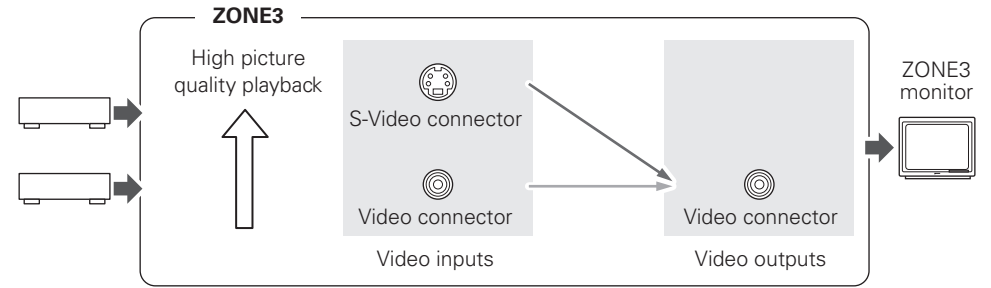

- When not using this function, connect a monitor output with the same type of connector as the video input connector.
- The resolution of the HDMI input-compatible monitor connected to the AVP-A1HD can be checked at GUI menu "Information" – "HDMI Information" – "Monitor1" or "Monitor2" (page 53).

### NOTE

- For optimum video performance, THX recommends that you set the conversion mode to "OFF" to use video signals pass through system without up conversion.
- Example:** View video input from a component video on the component video monitor.
- HDMI signals cannot be converted into analog signals.
- 1080p component input video signals cannot be output to anything other than component video connectors.
- 480p/576p, 1080i and 720p component video input signals cannot be converted into S-Video or Video format.
- When a non-standard video signal from a game machine or some other source is input, the video conversion function might not operate.

## Speaker Layout

The illustration below shows a basic example of installation of the amplifier combined with 8 speakers and a monitor.

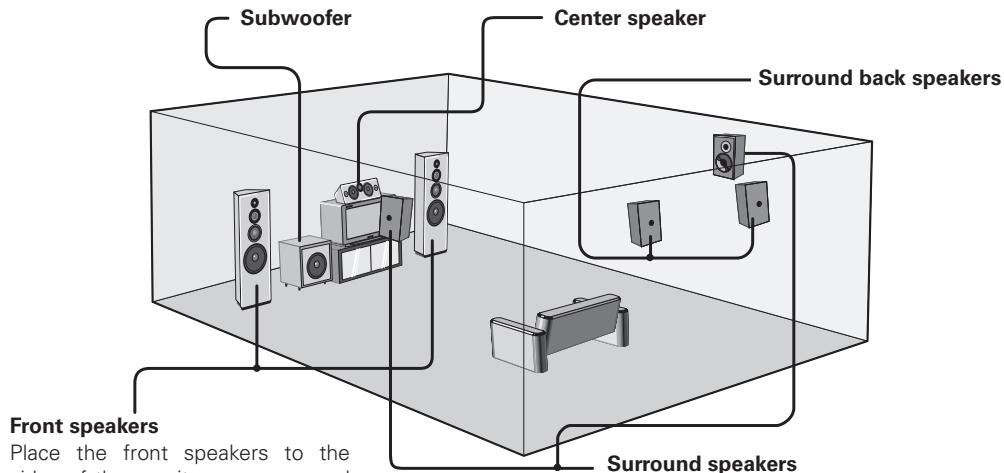

**Front speakers**  
Place the front speakers to the sides of the monitor or screen and as flush with the screen surface as possible.

Two surround back speakers are required to use the THX Ultra2 Cinema, THX Music mode and THX Games mode.

Set the surround back speakers so that the distance to the listening position is the same for both the left and right speakers. It is also recommended that the deviations of the distance from the listening position to L and R channel speakers (front left (FL) and front right (FR), surround left (SL) and surround right (SR), surround back left (SBL) and surround back right (SBR)) is less than 60 cm.



The table below shows a typical speaker configuration for the AVP-A1HD.

	FRONT		CENTER	SURROUND A		SURROUND B		SURROUND BACK			SUBWOOFER (※)
	L	R		L	R	L	R	L	R	1 only	
9.1-channels	○	○	○	○	○	○	○	○	○	-	○
7.1-channels	○	○	○	○	○	-	-	○	○	-	○
6.1-channels	○	○	○	○	○	-	-	-	-	○	○
5.1-channels	○	○	○	○	○	-	-	-	-	-	○
3.1-channels	○	○	○	-	-	-	-	-	-	-	○
2.1-channels	○	○	-	-	-	-	-	-	-	-	○
2-channels	○	○	-	-	-	-	-	-	-	-	-

※ The AVP-A1HD can be connected to a maximum of 3 subwoofers.

## Connecting to the Power Amp

- Connect the AVP-A1HD pre-out terminal to the power amp (sold separately).
- AVP-A1HD has a RCA pre-out terminal and XLR pre-out terminal. Connect accordingly with the power amp you want to use.
- The polarity of the XLR pre-out terminal can be switched using GUI menu “Manual Setup” – “Option Setup” – “XLR Out Polarity” (☞ page 38).
- Connect the speakers to the power amp.
- Refer to the owner’s manual of each piece of equipment when making connections.

## POA-A1HD Connection and Operation

- When connecting the AVP-A1HD to the power amp POA-A1HD with a control link cable (included with the POA-A1HD), you can perform the following control operations.
  - POA-A1HD channel input selection and power amp settings
  - Link POA-A1HD to AVP-A1HD On/Standby control
  - Link POA-A1HD meter operation to AVP-A1HD display on/off control (☞ page 41)
  - Updating POA-A1HD firmware (☞ page 41)
- Up to 2 POA-A1HD units can be connected. Refer to the POA-A1HD owner's manual for making connections and POA-A1HD settings.



- For instructions for connecting speakers, please refer to the POA-A1HD owner's manual.
- When using just one surround back speaker, connect it to the left channel (SBL).

**Connections**

When using Subwoofer 2 or 3, set GUI menu “Manual Setup” – “Speaker Setup” – “Subwoofer Setup” (page 28).

**Connecting the RCA pre-out terminal (Example : 9.3-channels)**

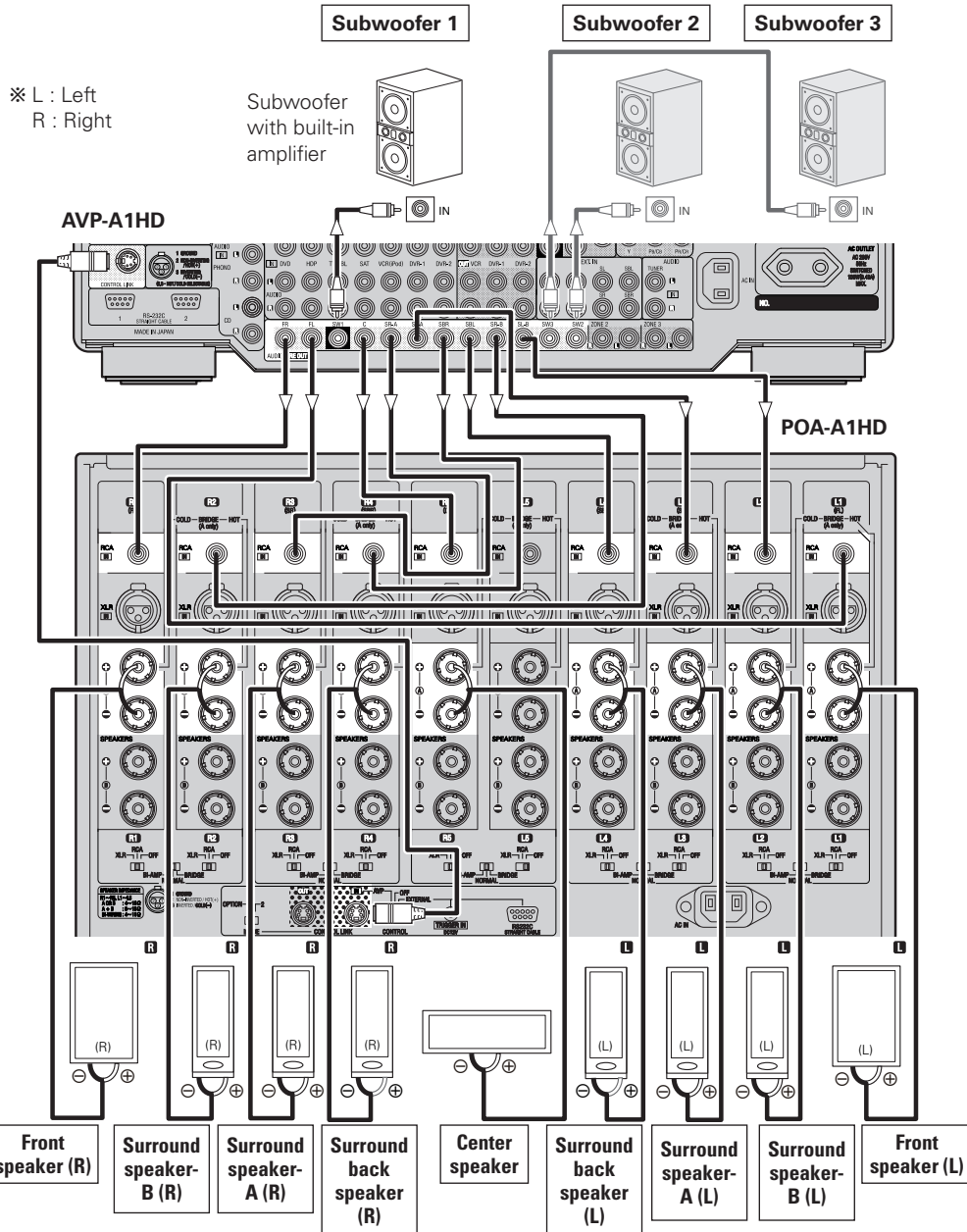

**Connecting the XLR pre-out terminal (Example : 9.3-channels)**

※ L : Left  
R : Right

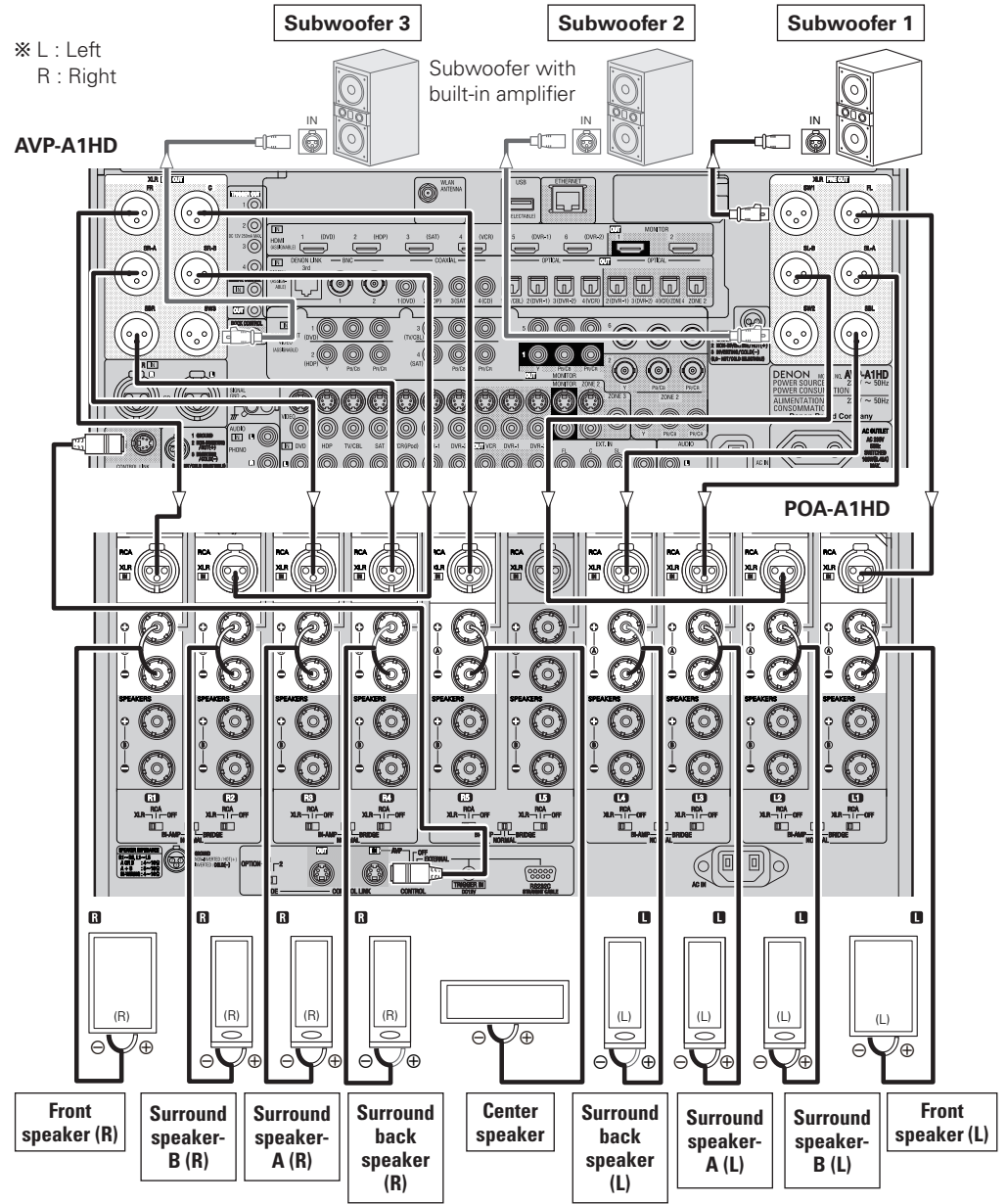

The default AVP-A1HD balance model XLR pre-out terminal pin alignment is as shown.

① : GROUND    ② : HOT    ③ : COLD



**Operations**

**1 Connect AVP-A1HD and POA-A1HD with the control link cable.**

※ The control link cable is included with the POA-A1HD.  
 ※ AVP-A1HD can be connected and control to up to 2 POA-A1HD units.  
 Refer to the POA-A1HD user's manual for how to connect.

**2 Set the POA-A1HD's control selector switch to "AVP".**

**3 Set the POA-A1HD's mode select switch according to the number of POA-A1HD units you are connecting.**

When connecting 1 unit : "1"  
 When connecting 2 units : 1st unit "1", 2nd unit "2"  
 ※ Refer to the POA-A1HD owner's manual for details.

**4 Switch the AVP-A1HD and POA-A1HD power on.**

**5 Depending on the number of POA-A1HD units to be connected, set GUI menu "Option Setup" - "POA Setting" - "POA LINK" to either "ON (Single)" or "ON (Dual)" (☞ page 38).**

**6 Use GUI menu "Option Setup" - "POA Setting" - "LINK Check" to check the connection.**

**Connecting Equipment with HDMI connectors**

With HDMI connections, the video and audio signals can be transferred with a single cable.

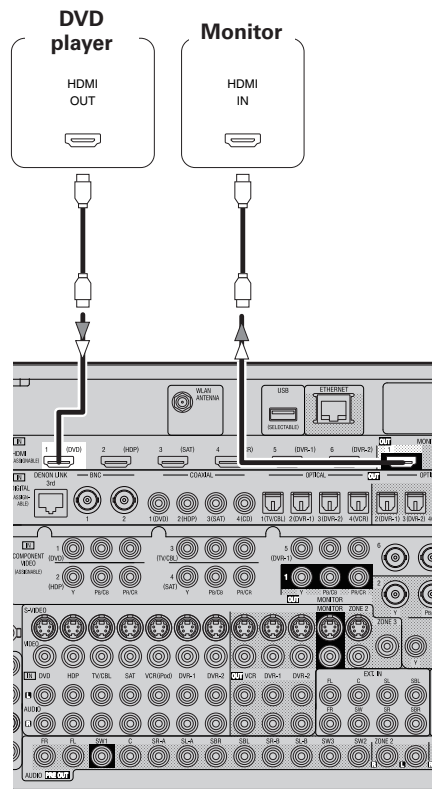

- By default, HDMI sound is output from the speaker of the power amp connected to AVP-A1HD.
- To output the sound from the TV, make the settings at GUI menu "Manual Setup" - "HDMI Setup" - "Audio" - "TV" (☞ page 31).

- ※ The AVP-A1HD is supported to the feature of HDMI listed below.
- 30 and 36 bit Deep Color
  - xvYCC
  - Auto Lipsync Correction

Compatible audio format	Details	Discs (examples)
2-channel linear PCM	2ch 32-192 kHz 16/20/24 bits	CD, DVD-Video, DVD-Audio
Multi-channel linear PCM	8ch 32-192 kHz 16/20/24 bits	DVD-Audio
Dolby Digital, DTS	Bitstream	DVD-Video
DSD	2/5.1ch 2.8224 MHz 1 bit	SACD
Dolby Digital Plus, Dolby TrueHD, DTS-HD	Bitstream	HD DVD, Blu-ray Disc

**Copyright protection system (HDCP)**

In order to play the digital video and audio signals of a DVD-Video or DVD-Audio disc using HDMI/DVI connections, both the connected DVD player and monitor must be equipped for a copyright protection system called "HDCP" (High-bandwidth Digital Content Protection). HDCP is a copy protection technology consisting of data encoding and mutual identification of the devices. The AVP-A1HD is HDCP-compatible. For details on the DVD player or monitor you are using, refer to its operating instructions.

**When connecting with an HDMI/DVI converter cable (adapter)**

- HDMI video signals are theoretically compatible with the DVI format. When connecting to a monitor, etc., equipped with a DVI-D connector, connection is possible using an HDMI/DVI converter cable, but depending on the combination of components in some cases the video signals will not be output.
- When connecting using an HDMI/DVI converter adapter, the video signals may not be output properly due to poor connections with the connected cable, etc.



**NOTE**

- Use a CPPM-compatible DVD player to play DVD-Audio discs that are copyright-protected by CPPM.
- The audio signals output from the HDMI connector (sampling frequency, bit rate, etc.) may be restricted by the connected device.
- Video signals are not output properly when using devices that are not HDCP-compatible.
- Video signals are not output if the input video signals do not match the monitor's resolution. In this case, switch the DVD player's resolution to a resolution with which the monitor is compatible.
- If the GUI menu "Manual Setup" – "HDMI Setup" – "Audio" setting (page 31) is set to "Amp", the sound may be interrupted when the monitor's power is turned off.
- Use a cable on which the HDMI logo is indicated (a certified HDMI product) for connection to the HDMI connector. Normal playback may not be possible when using a cable other than one on which the HDMI logo is indicated (a non-HDMI-certified product).
- If the monitor or DVD player does not support Deep Color, Deep Color signal transfer is not possible.
- If the monitor or DVD player does not support xvYCC, xvYCC signal transfer is not possible.
- If the monitor does not support "Auto Lipsync Correction" function, this function will not work.
- The AVP-A1HD is compatible with the HDMI's CEC (Consumer Electronics Control) function. Please note the following.
  - It may not work depending on the device it is connected to and its setup.
  - It does not operate with televisions or players that are not compatible with HDMI's CEC.



- When the AVP-A1HD and DVD player are connected using an HDMI cable, also connect the AVP-A1HD and monitor using an HDMI cable.
- If the connected monitor or DVD player only has a DVI-D connector, use an HDMI/DVI converter cable. When using a DVI cable, no audio signals are transmitted.
- Use a Deep Color compatible cable for connection to Deep Color compatible devices.

**Connecting the Monitor**

- Connect the cables to be used (page 9 "Video Conversion Function").
- With HDMI connections, the video and audio signals can be transferred with a single cable.
- To output the audio signals to the monitor with HDMI connections, set GUI menu "Manual Setup" – "HDMI Setup" – "Audio" to "TV" (page 31).

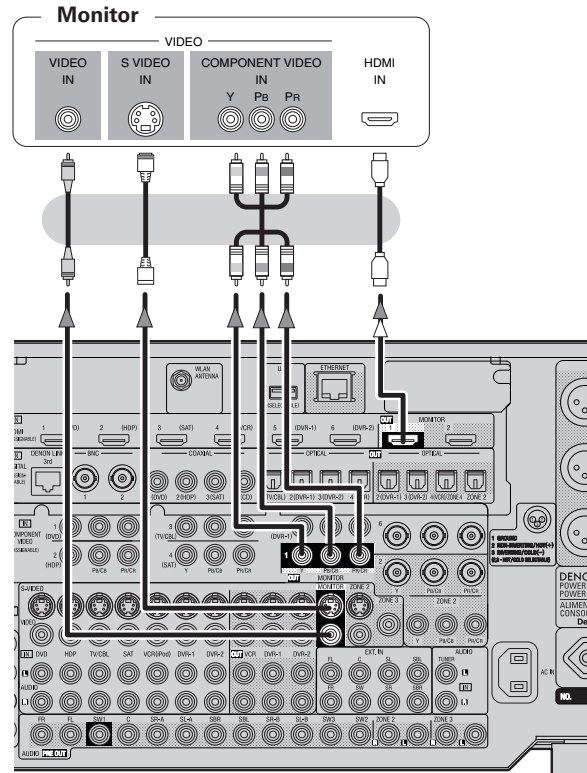

**NOTE**

- The component video connectors may be indicated differently on your monitor. For details, see the monitor's operating instructions.
- The audio signals output from the HDMI connectors are only the HDMI input signals.

**Connecting the Playback Components**

Carefully check the left (L) and right (R) channels and the inputs and outputs, and be sure to interconnect correctly.

**DVD Player**

- Connect the cables to be used.
- With HDMI connections, the video and audio signals can be transferred with a single cable.

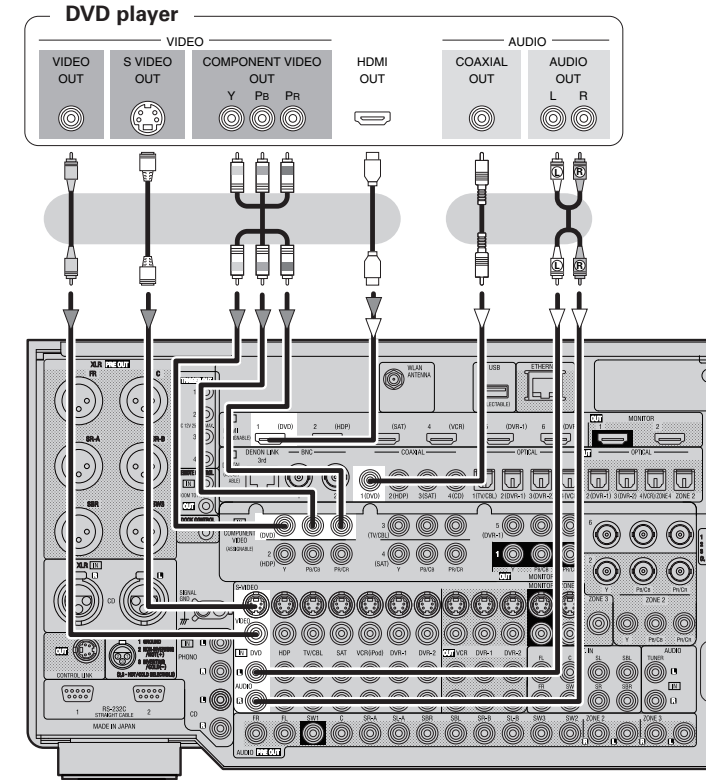

- Connect an HDP (High-Definition Player) in the same way.
- When using an optical cable or a BNC cable for the digital audio connection, make the settings at GUI menu "Source Select" – "DVD" – "Assign" – "Digital" (page 44).
- When using a BNC cable for the component video connection, make the settings at GUI menu "Source Select" – "DVD" – "Assign" – "Component" (page 44).

## Record Player

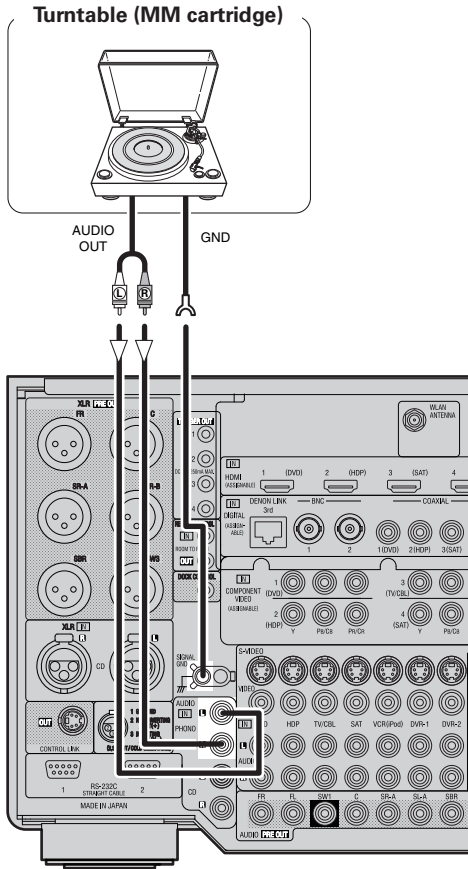

- When connecting a record player with an MC cartridge, use a commercially available MC head amplifier or a step-up transformer.
- Induction humming (a booming sound) may be produced from the speakers if the volume is raised with no record player connected.
- With some record players, noise may be generated when the ground wire is connected. If so, disconnect the ground wire.

### NOTE

The AVP-A1HD's SIGNAL GND terminal is meant to reduce noise when a record player is connected. This is not a safety ground terminal.

## CD Player

Connect the cables to be used.

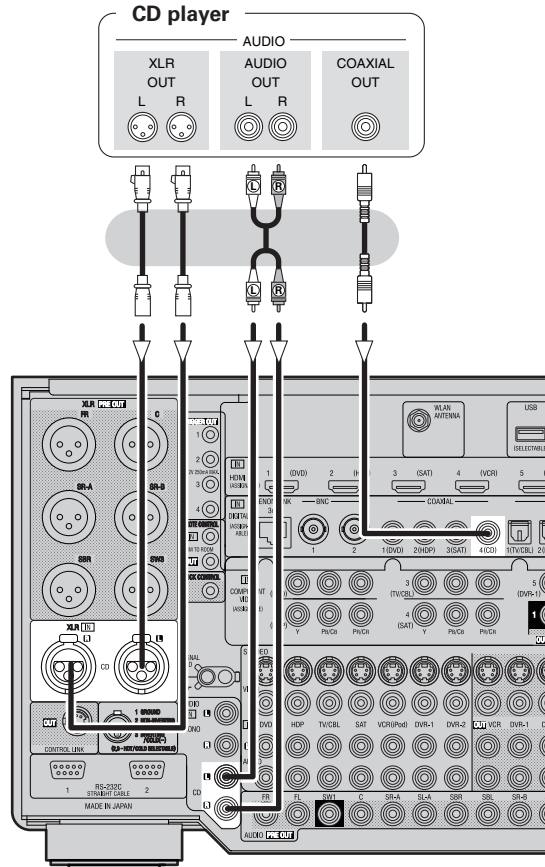

- When using an optical cable or a BNC cable for the digital audio connection, make the settings at GUI menu "Source Select" – "CD" – "Assign" – "Digit" (page 44).
- The default analog audio input setting is "RCA". When using a balanced cable for the analog audio connection, make the settings at GUI menu "Source Select" – "CD" – "Assign" – "Analog" (page 44).

### NOTE

The default AVP-A1HD balance model XLR audio connectors pin alignment is as shown.

- ① : GROUND
- ② : HOT
- ③ : COLD



## iPod®

Use a DENON Control Dock for iPod (ASD-1R, sold separately) to connect the iPod to the AVP-A1HD. For instructions on the Control Dock for iPod settings, refer to the Control Dock for iPod's operating instructions.

Example :

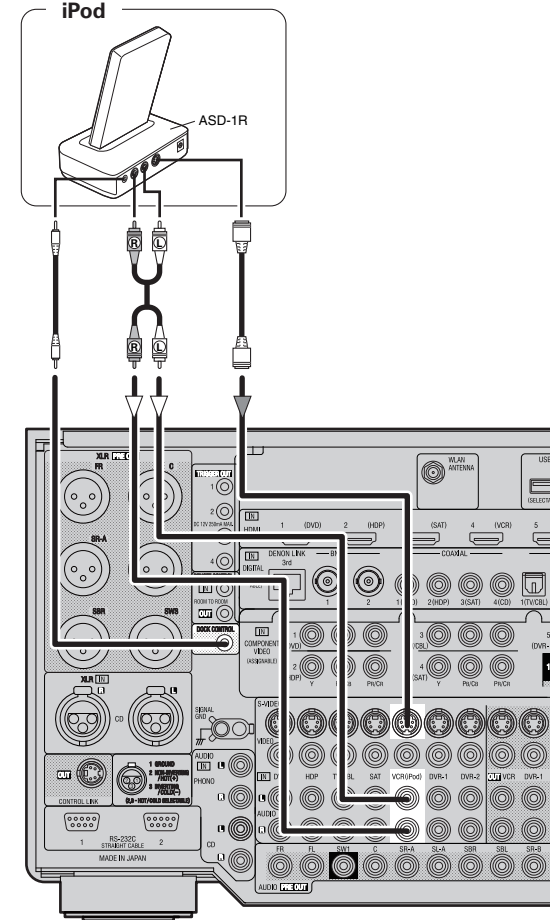

- With the default settings, the iPod can be used connected to the VCR (iPod) connector.
- To assign the iPod to a connector other than VCR (iPod), make the settings at GUI menu "Source Select" – "(input source to which iPod dock assigned)" – "Assign" – "iPod dock" (page 44).

## TV/CABLE Tuner

Connect the cables to be used.

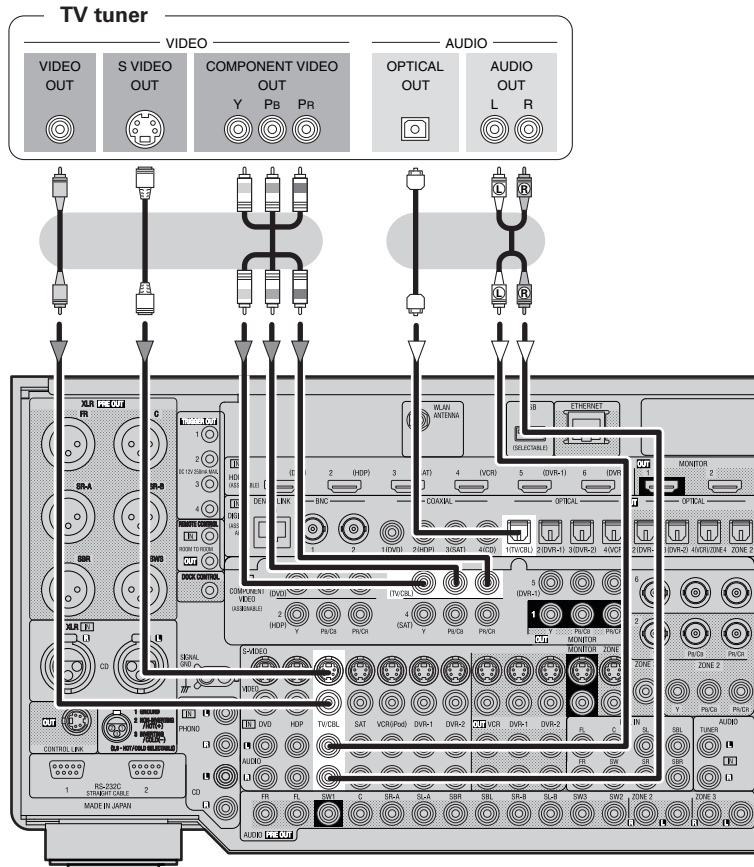

- When using a coaxial digital cable or a BNC cable for the digital audio connection, make the settings at GUI menu "Source Select" – "TV/CBL" – "Assign" – "Digital" (page 44).
- When using a BNC cable for the component video connection, make the settings at GUI menu "Source Select" – "TV/CBL" – "Assign" – "Component" (page 44).

## Satellite Receiver

Connect the cables to be used.

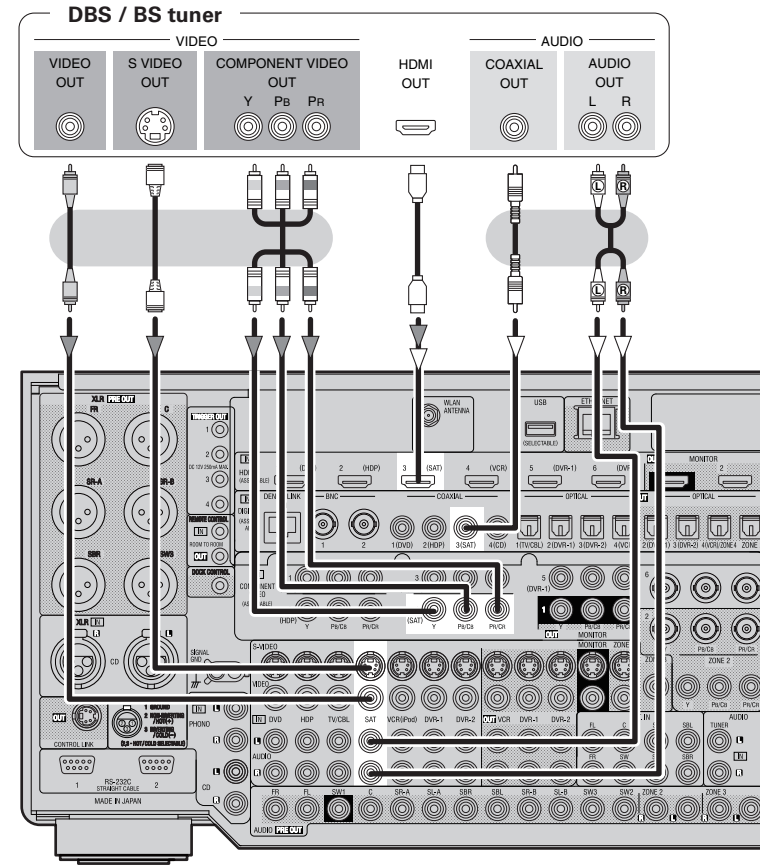

- When using an optical cable or a BNC cable for the digital audio connection, make the settings at GUI menu "Source Select" – "SAT" – "Assign" – "Digital" (page 44).
- When using a BNC cable for the component video connection, make the settings at GUI menu "Source Select" – "SAT" – "Assign" – "Component" (page 44).

# Connecting the Recording Components

Carefully check the left (L) and right (R) channels and the inputs and outputs, and be sure to interconnect correctly.

## Digital Video Recorder

Connect the cables to be used.

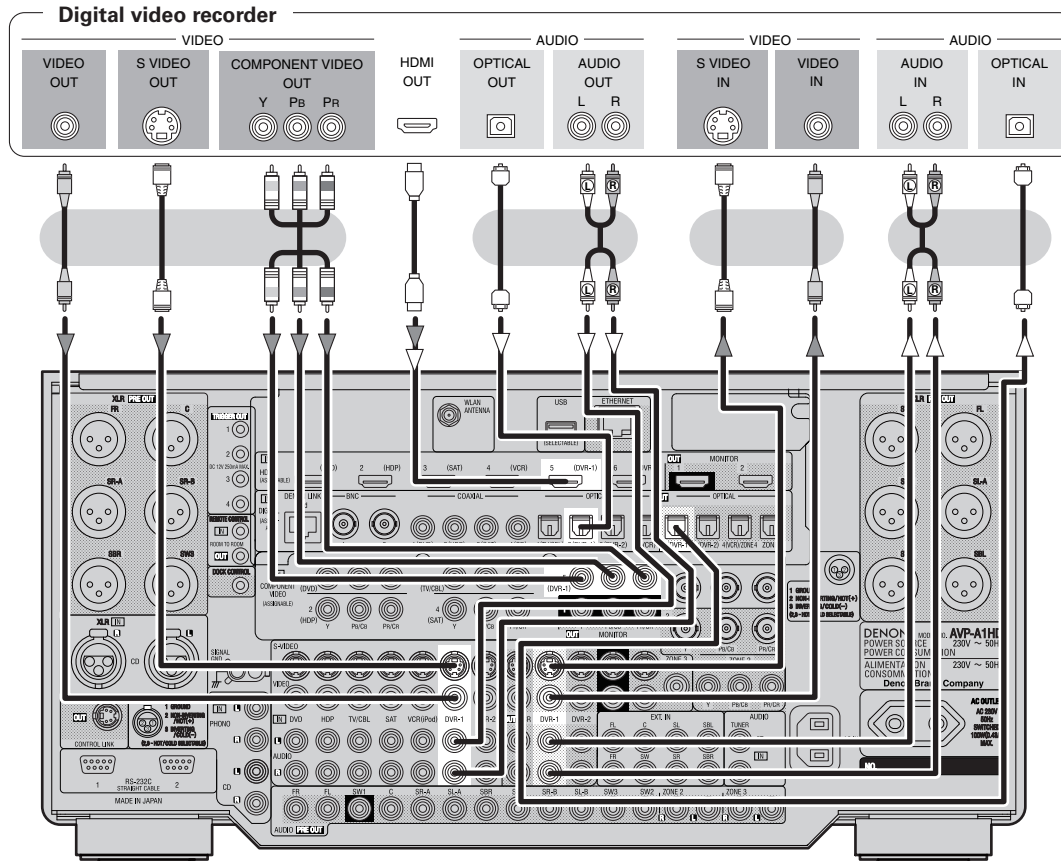

- Make analog connections if you wish to record analog audio signals.
- When recording to a digital video recorder, it is necessary that the type of cable used with the playback source equipment be the same type that is connected to the AVP-A1HD DVR-1 OUT connector.  
**Example:** TV IN → S-Video cable : DVR-1 OUT → S-Video cable  
 TV IN → Video cable : DVR-1 OUT → Video cable

- Connect a DVR-2 in the same way.
- When using a component video cable or a BNC cable for the component video connection of DVR-2, make the settings at GUI menu "Source Select" - "DVR-1" or "DVR-2" - "Assign" - "Component" (page 44).

### NOTE

- Do not connect the output of the component connected to the AVP-A1HD's OPTICAL2 output connector to any input connector other than OPTICAL2.
- Do not connect the output of the component connected to the AVP-A1HD's OPTICAL3 output connector to any input connector other than OPTICAL3.

## Video Cassette Recorder

Connect the cables to be used.

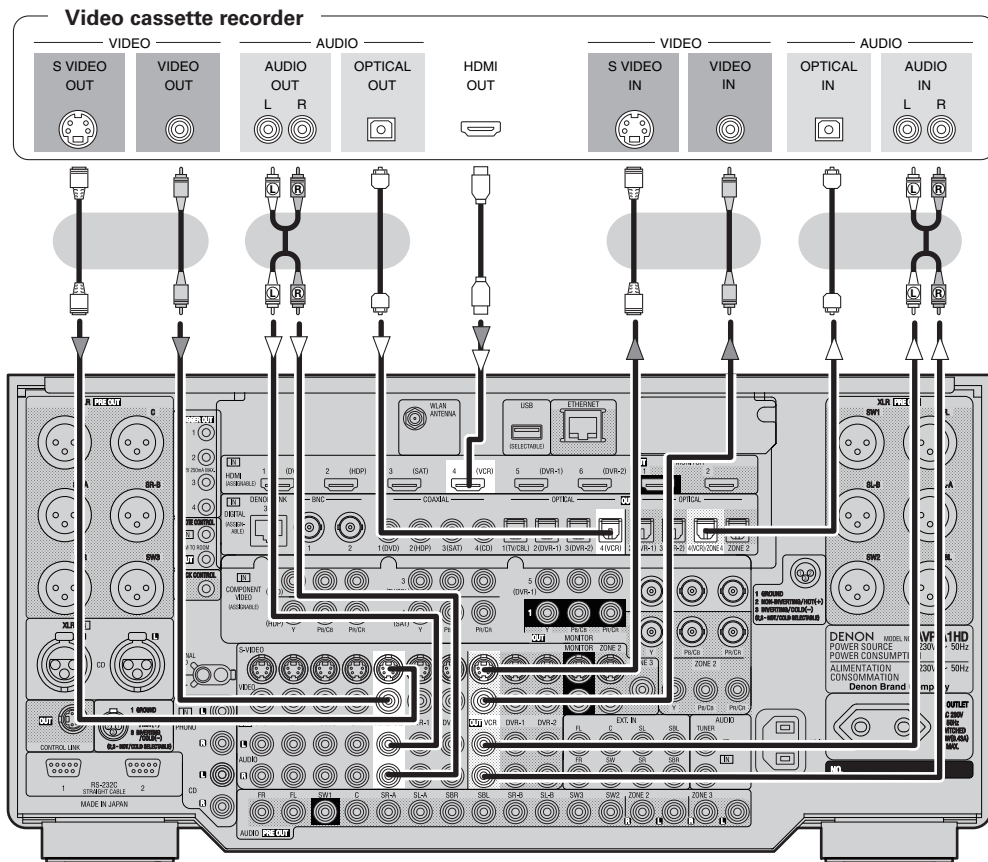

- When recording to a VCR, it is necessary that the type of cable used with the playback source equipment be the same type that is connected to the AVP-A1HD VCR OUT connector.

**Example:** TV IN → S-Video cable : VCR OUT → S-Video cable  
 TV IN → Video cable : VCR OUT → Video cable

- When using a component video cable or a BNC cable for the video connection, make the settings at GUI menu "Source Select" – "VCR" – "Assign" – "Component" (page 44).

### NOTE

Do not connect the output of the component connected to the AVP-A1HD's OPTICAL4 output connector to any input connector other than OPTICAL4.

## CD Recorder / MD Recorder / Tape Deck

Make analog connections if you wish to record analog audio signals, or digital connections if you wish to record digital audio signals, depending on the types of connectors on the components being used.

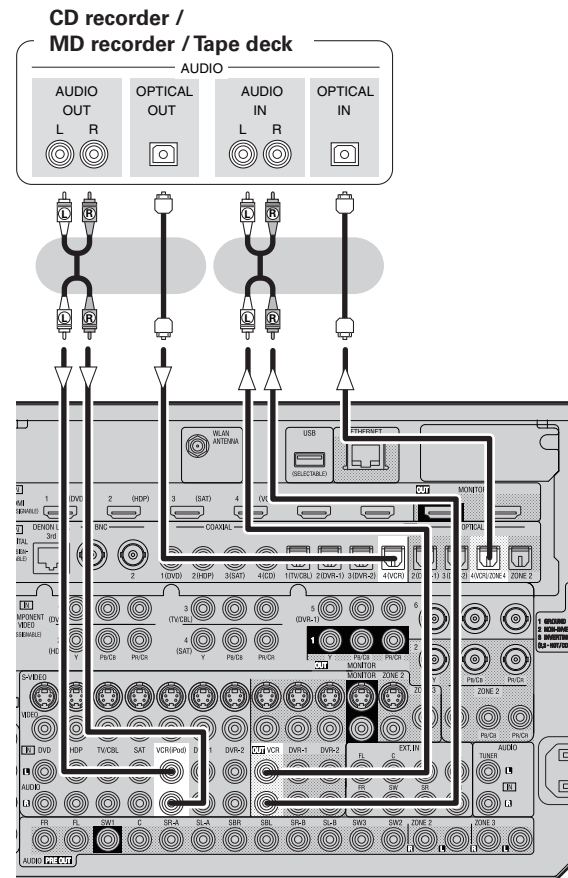

### NOTE

Do not connect the output of the component connected to the AVP-A1HD's OPTICAL4 output connector to any input connector other than OPTICAL4.

## Connections to Other Devices

Carefully check the left (L) and right (R) channels and the inputs and outputs, and be sure to interconnect correctly.

### Components Equipped with a DENON LINK connector

Multi-channel playback is possible with DVD-Audio discs, Super Audio CD, etc.

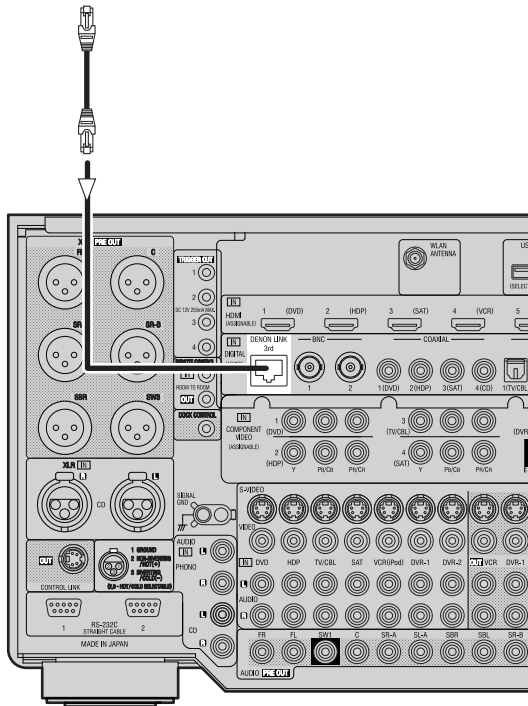
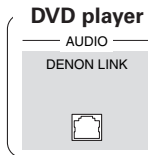

To use with DENON LINK connections, make the settings at GUI menu "Source Select" - "(input source)" - "Assign" - "Digital" - "DENON LINK" (page 44).

## Video Camera / Game Console

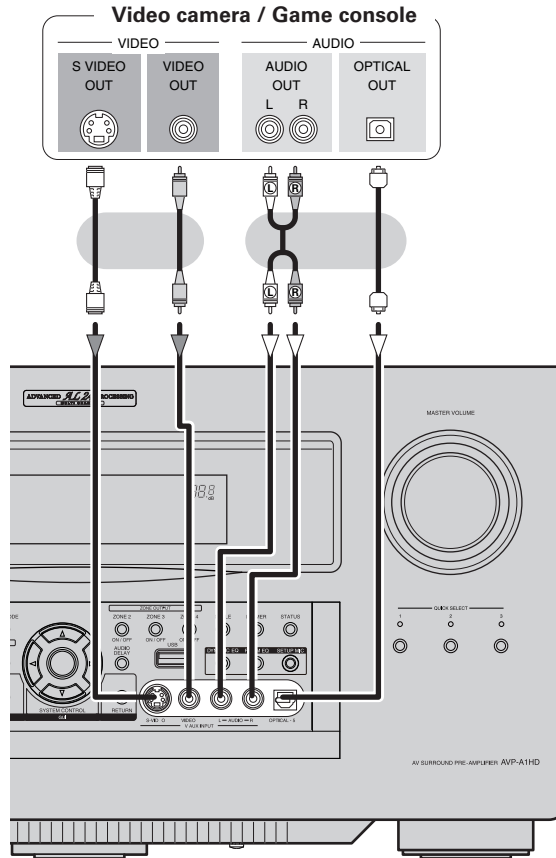

## Component with Multi-channel Output connectors

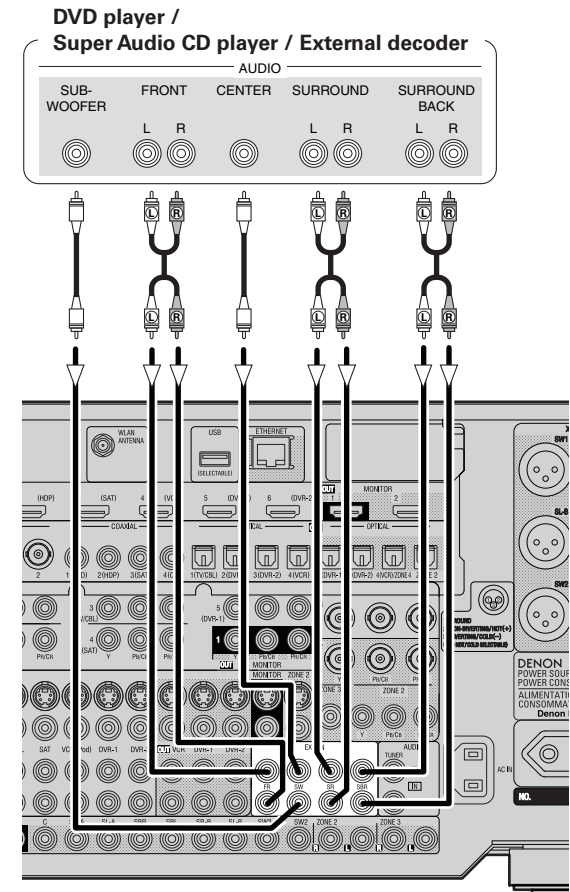

- To play the analog input signals input to the EXT. IN connectors, press the **INPUT MODE** button on the main unit or **INPUT** button on the main remote control unit and select "EXT. IN" or make the settings at GUI menu "Source Select" - "(input source)" - "Input Mode" - "Input Mode" - "EXT. IN" (page 45).
- The video signal can be connected in the same way as a DVD player (page 13).
- To play copyright-protected discs, connect the AVP-A1HD's EXT. IN connector with the DVD player's analog multi-channel output connector.

USB Port

□ Front panel

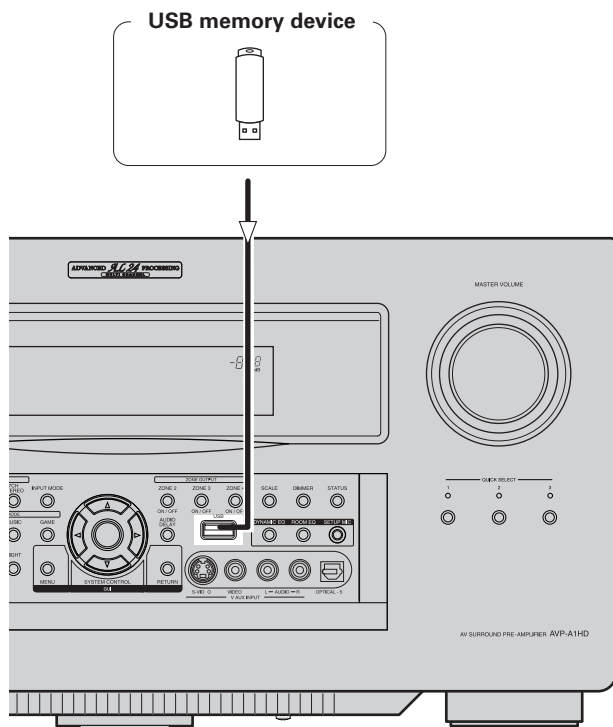

□ Rear panel

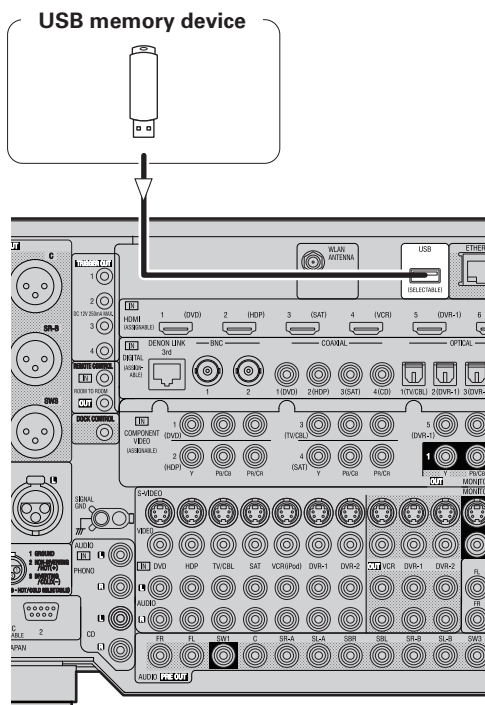

- In the initial status, USB memory devices can be used by connecting them to the USB port on the front panel.
- To change the port to be used, see “USB Select” on page 46.
- For instructions on playing the files on a USB memory device, see page 60, 61.

**NOTE**

- Set to the USB port you want to use.
- The AVP-A1HD is equipped with two USB ports, one each on the front and rear panels. It is not possible to use the set with USB memory devices connected to both the ports at the same time. Select the USB port you want to use at the GUI menu “Source Select” – “NET/USB” – “Playback Mode” – “USB Select.”
- Do not use the extension cable for connecting the USB memory device to the AVP-A1HD’s USB port. Use of the extension cable may cause harmful interference.

## Network Audio

### [Wired LAN]

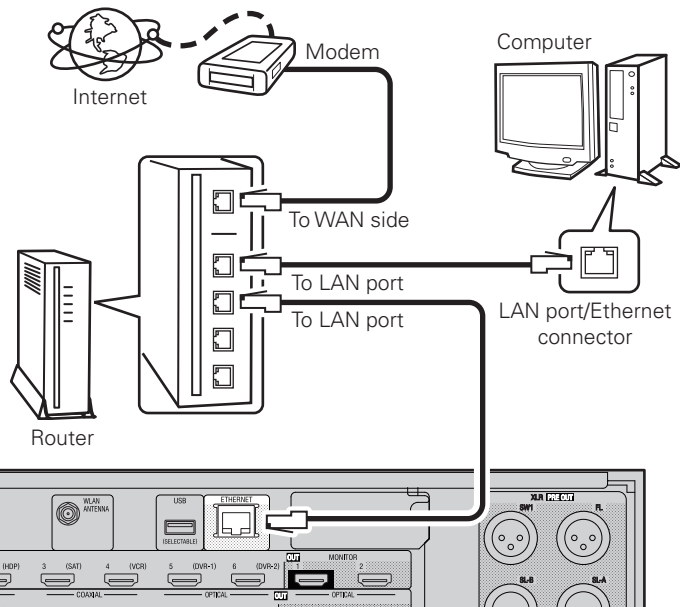

### [Wireless LAN]

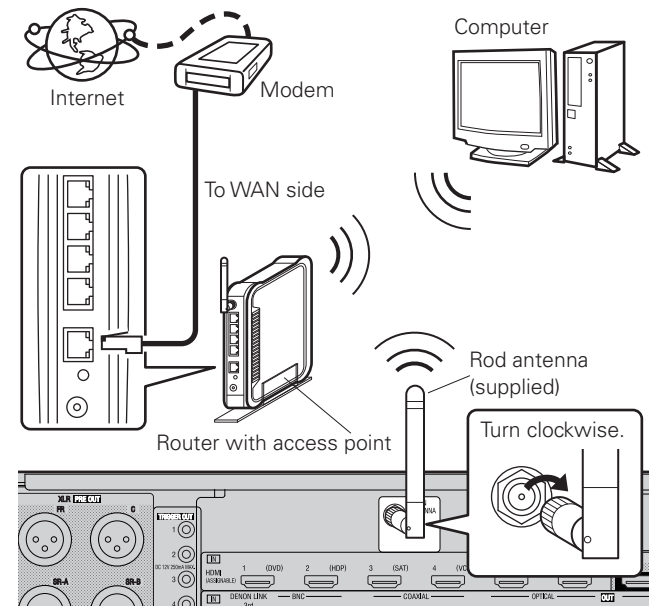

## Required system

### ❑ Broadband Internet connection

A broadband line connection to the Internet is required in order to use the AVP-A1HD's Internet radio function and firmware update.

### ❑ Modem

This is a device that is connected to the broadband line to communicate with the Internet. Some are integrated with the router.

### ❑ Router

When using the AVP-A1HD, we recommend you use a router equipped with the following functions:

- Built-in DHCP (Dynamic Host Configuration Protocol) server  
This function automatically assigns IP addresses on the LAN.
- Built-in 100BASE-TX switch  
When connecting multiple devices, we recommend a switching hub with a speed of 100 Mbps or greater.
- When using with a wireless LAN, prepare a broadband router with built-in access point.

### ❑ Ethernet cable (CAT-5 or greater recommended)

Use for wired LAN.

- The AVP-A1HD does not come with an Ethernet cable.
- Some flat type Ethernet cables are easily affected by noise.  
We recommend using a normal type cable.
- For the Ethernet cable, used a shielded twisted pair (STP) cable. Do not use an unshielded twisted pair (UTP) cable, as it may exceed noise standard limits.

### ❑ Computer

A computer with the following specifications is required to use a media server:

- OS  
Windows® XP Service Pack2, Windows Vista
  - Software (Prepare one of the following.)
    - .NET Framework 1.1 and Windows Media Connect (Windows XP)
    - Windows Media Player ver.11
    - DLNA-compatible server software
  - Internet browser  
Microsoft Internet Explorer 5.01 or later
  - LAN port
  - 300 MB or more free disk space
- ※ Free disk space is required to store music and video files. The following sizes are approximate.

Format	Bit rate	Per minute	Per hour
MP3 / WMA	128 kbps	Approx. 1 MB	Approx. 60 MB
	192 kbps	Approx. 1.5 MB	Approx. 90 MB
	256 kbps	Approx. 2 MB	Approx. 120 MB
MPEG-4 AAC	392 kbps	Approx. 3 MB	Approx. 180 MB
	1400 kbps	Approx. 10 MB	Approx. 600 MB
WAV (LPCM)	1080 kbps	Approx. 7.7 MB	Approx. 464 MB
FLAC			



For connections to the Internet, contact an ISP (Internet Service Provider) or a computer shop.

### NOTE

- A contract with an ISP is required to connect to the Internet.  
No additional contract is needed if you already have a broadband connection to the Internet.
- The types of routers that can be used depend on the ISP. Contact an ISP or a computer shop for details.
- Depending on the server, video files may be displayed, but they cannot be played on the AVP-A1HD.

### ❑ Others

- If you have an Internet provider contract for a line on which network settings are made manually, make the settings at GUI menu "Manual Setup" – "Network Setup" (☞ page 34, 35).
- With the AVP-A1HD, it is possible to use the DHCP and Auto IP functions to make the network settings automatically.
- When using a broadband router (DHCP function), the AVP-A1HD sets the IP address, etc., automatically.  
When using the AVP-A1HD connected to a network with no DHCP function, make the settings for the IP address, etc., at GUI menu "Manual Setup" – "Network Setup" (☞ page 34, 35).
- The AVP-A1HD is not compatible with PPPoE. A PPPoE-compatible router is required if you have a contract for a line of the type with which the PPPoE is set.
- Depending on the ISP with which you have your contract, it may be necessary to make proxy server settings to use the Internet radio function. If you made proxy server settings on the computer to connect to the Internet, make the proxy server settings on the AVP-A1HD in the same way.



## Multi Zone

### ZONE2 or ZONE3 Pre-out Connections

- If another power amplifier or pre-main (integrated) amplifier is connected, the ZONE2 or ZONE3 pre-out connectors can be used to play a different program source in ZONE2 or ZONE3 the same time (☞ page 75, 76).
- To the monitor output of ZONE2, various formats of video signals input by the video conversion function are automatically converted and output (☞ page 9).
- To the monitor output of ZONE3, video signals input from the S video terminal or video terminal is output (☞ page 9).
- The ZONE2 (ZONE3) video out is only for ZONE2 (ZONE3).

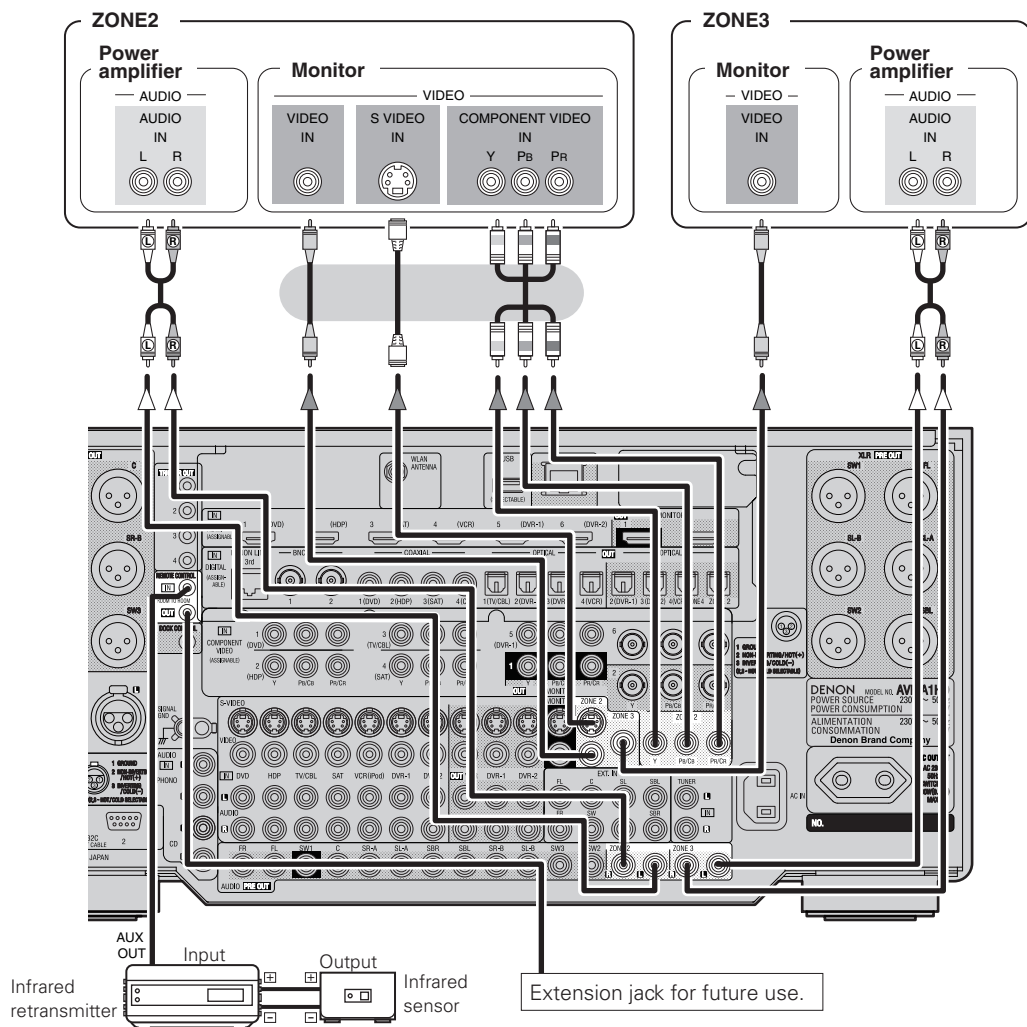

### NOTE

- For the audio output, use high quality pin-plug cords so that no induction humming or noise is produced.
- For instructions on installing and operating separately sold devices, refer to the respective devices' operating instructions.
- To conduct multi-zone playback, see "Multi-Zone Connections and Operations" (☞ page 75, 76).

### ZONE2 or ZONE4 Optical Connections

The AVP-A1HD is equipped with Optical output connectors for ZONE2 and ZONE4. If a bit-stream amp is rigged-up, these zones can also be used to enjoy home theater.

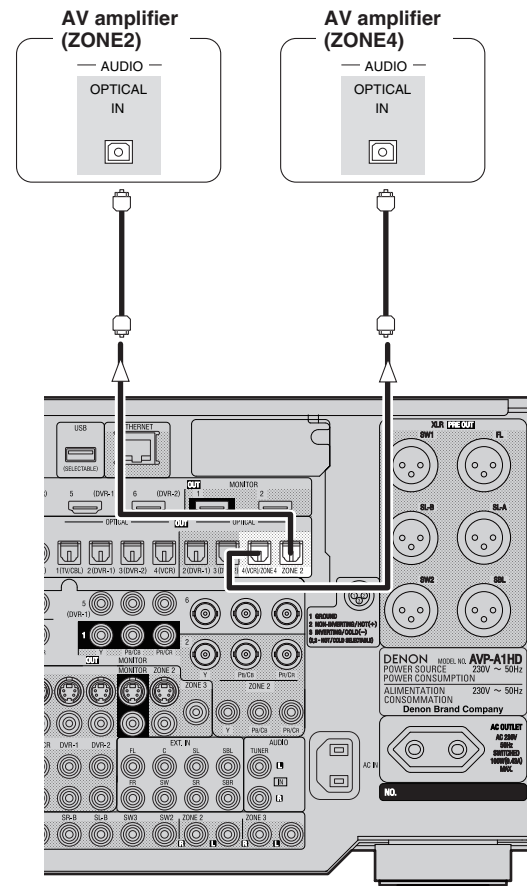

- Connect the monitor for ZONE2 the same as the "ZONE2 or ZONE3 Pre-out Connectors" (☞ See left column).
- If the signal inputted to ZONE2 is analog, change to PCM(2-channel) signal, and output it from ZONE2 optical output connectors.

## External Controller

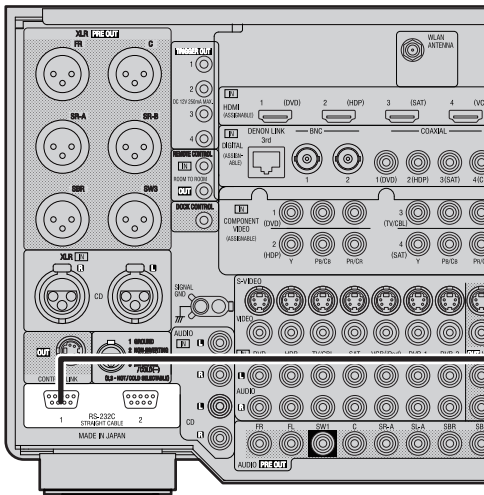

### RS-232C connector

This connector is used for an external controller.

※ If you use an external controller to operate the unit via the RS-232C terminal, you must confirm the following beforehand.

- ① Turn on the AVP-A1HD's power.
- ② Turn off the AVP-A1HD's power from the external controller.
- ③ AVP-A1HD enters the standby status.



- When using in combination with an RF Remote Controller (RC-7000CI, sold separately) and RF Remote Receiver (RC-7001RCI, sold separately) two-way communication with an RF Remote Controller is possible. The AVP-A1HD's status information as well as iPod and Internet audio music files can be browsed watching the RF Remote Controller's display. For details, refer to the operating instructions of the respective devices.
- When used in combination with an RF Remote Controller and RF Remote Receiver, make the settings at GUI menu "Manual Setup" – "Option Setup" – "2Way Remote" – "Used" (page 40).
- When using the 2-way remote control unit, connect to the Port 1 RS-232C connector.
- If GUI menu "Manual Setup" – "Option Setup" – "2Way Remote" is set to "Used", you cannot use port 1 of the RS-232C terminal for the external controller.

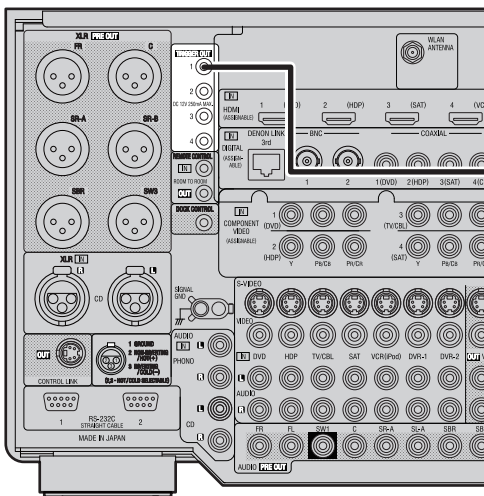

### Trigger output jacks

The power of an external device equipped with a trigger input jack can be turned on and off in association with operations on the AVP-A1HD. For details, see GUI menu "Manual Setup" – "Option Setup" – "Trigger Out 1", "Trigger Out 2", "Trigger Out 3" or "Trigger Out 4" (page 40).

- Output level: 250 mA/12 V
- Check the trigger input conditions of the connected device.

## Connecting the Power Cord

Wait until all connections have been completed before connecting the power cord.

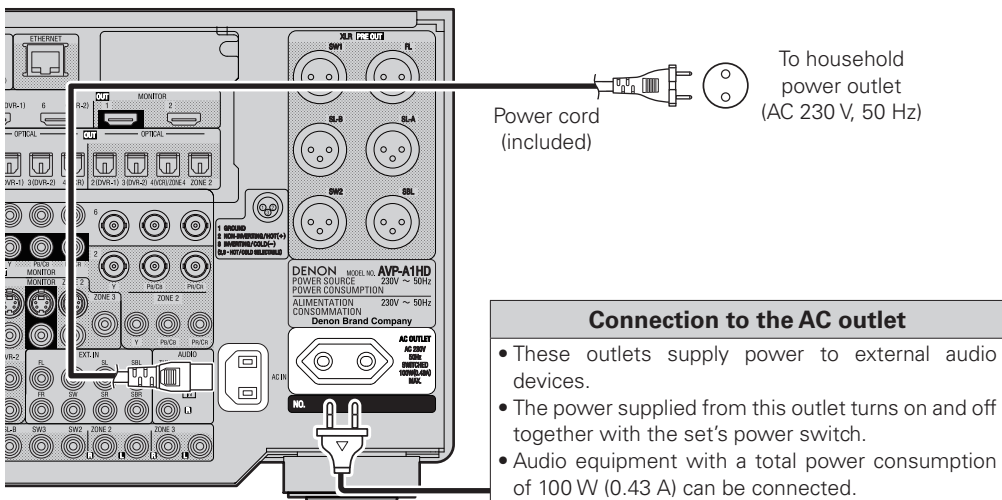

To household power outlet (AC 230 V, 50 Hz)

Power cord (included)

### Connection to the AC outlet

- These outlets supply power to external audio devices.
- The power supplied from this outlet turns on and off together with the set's power switch.
- Audio equipment with a total power consumption of 100 W (0.43 A) can be connected.

### NOTE

- Insert the AC plugs securely. Incomplete connections could cause noise.
- Only use the AC outlet to plug in audio devices. Do not use them as power supplies for hairdryers or anything other than audio equipment. In addition, do not connect audio devices such as high electricity consumption power amplifiers (e.g. POA-A1HD).

## Once Connections are Completed

### Turning the Power On (page 54)

# GUI Menu Operations

With the AVP-A1HD, settings and operations for most functions can be performed by operating while looking at the GUI menus displayed on the monitor screen.



The GUI cannot be superimposed when xvYCC signals and component 1080p signal, computer's resolution (e.g.VGA) are input.

## Example of the Display of the GUI Mark at a Title

Items for which this mark is indicated at the title can be operated from the GUI.  
We recommend performing such operations from the GUI.

### Auto Setup

Optimize settings for speakers in use.



This is the GUI icon for this setting item or for the menu series to which this item belongs.

## Example of Display of Default Values

In lists of selectable items or adjustable ranges, the item surrounded by a border is the default value.

[Selectable items] **9.1** 7.1 5.1

## Examples of GUI Screen Displays

Some typical examples are described below.

### Example: Browse Menu (Top Menu)

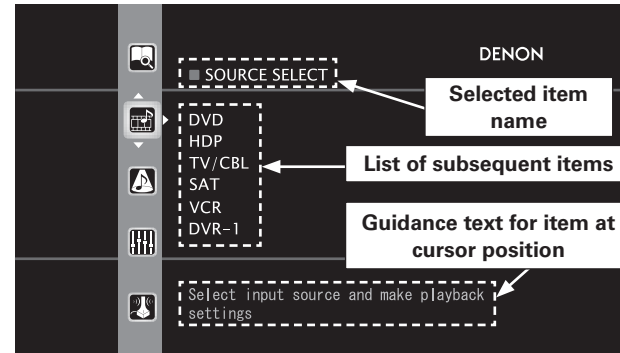

### Example: Menus with Illustrations (Auto Setup)

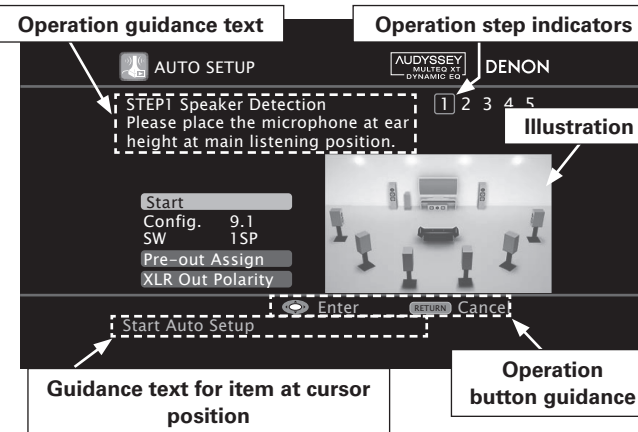

## Cursor Position Display

### Icon

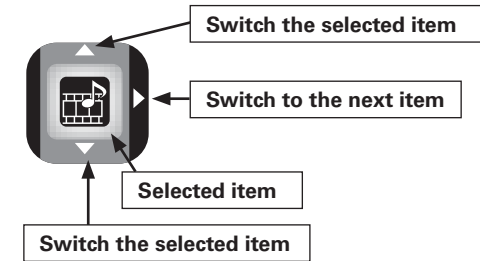

### List

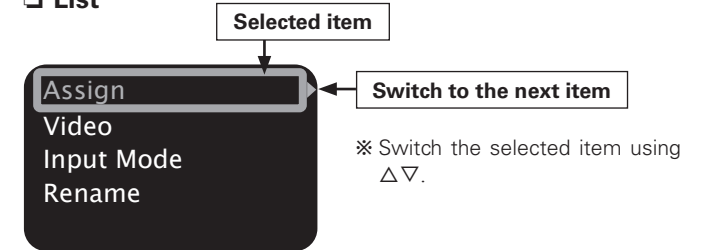

## Operations

The same operation is possible on the main unit or remote control unit.

- 1 Press the MENU button.**  
The GUI menu is displayed.  
※ To operate from the main remote control unit, be sure to set the remote control unit to the AMP mode.
- 2 Press the Δ ∇ ▷ button to select the menu to be set or operated.**  
※ To return to the previous item, press the ◀ or RETURN button.
- 3 Press the ENTER button to enter the setting.**
- 4 Press the MENU button to finish.**

# GUI Menu Map

- Getting Started
- Connections
- Setup
- Playback
- Remote Control
- Multi-Zone
- Information
- Troubleshooting

### Information

(page 52, 53)

- Status
  - MAIN ZONE
  - ZONE2/3/4
- Audio Input Signal
- HDMI Information
- Auto Surround Mode
- Quick Select
- Preset Station

### Parameter

(page 48 ~ 52)

- Audio
  - Surround Parameters
    - Mode
    - Decoder
    - Cinema EQ
    - DRC
    - D.COMP
    - LFE
    - Center Image
    - Panorama
    - Dimension
    - Center Width
    - Delay Time
    - Effect
    - Effect Level
    - Room Size
    - AFDM
    - SB CH Out
    - Input Channel
    - Subwoofer Att.
    - Subwoofer
    - Default
  - Tone
    - Tone Defeat
    - Bass
    - Treble
    - Front
    - Center
    - Surround
    - Surround Back
    - Subwoofer
  - Room EQ
  - Dynamic EQ
  - RESTORER
  - Night Mode
  - Audio Delay
- Picture Adjust
  - Contrast
  - Brightness
  - Chroma Level
  - Hue
  - DNR
  - Enhancer
  - Sharpness

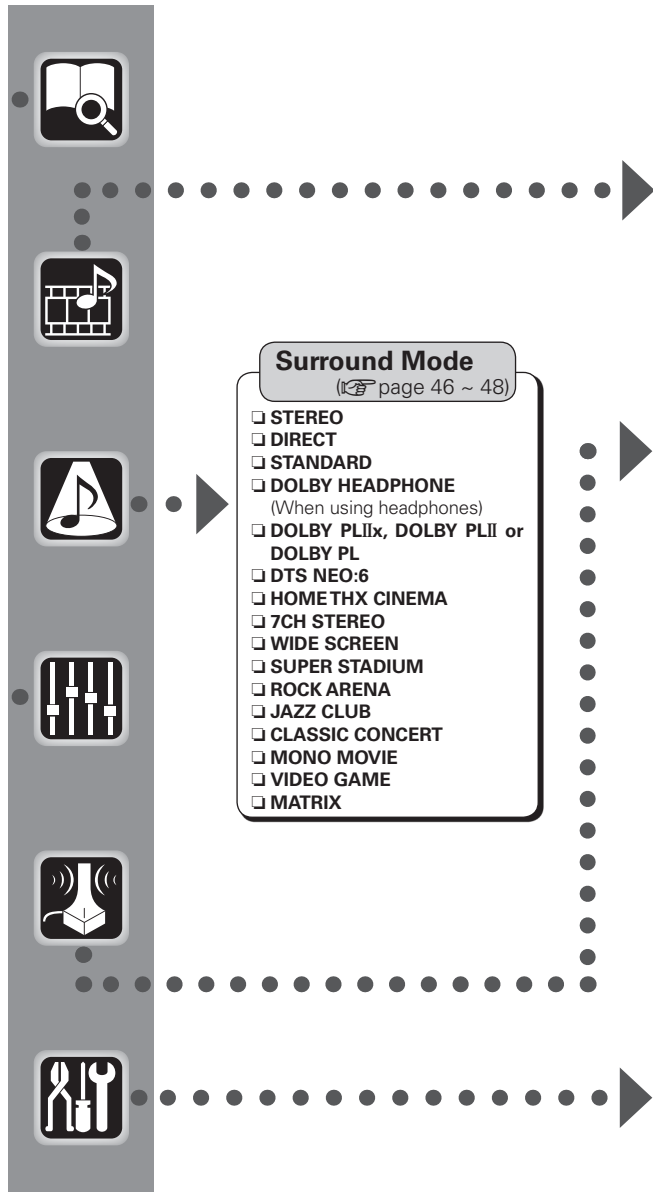

### Surround Mode

(page 46 ~ 48)

- STEREO
- DIRECT
- STANDARD
- DOLBY HEADPHONE  
(When using headphones)
- DOLBY PLIIx, DOLBY PLII or DOLBY PL
- DTS NEO:6
- HOMETHX CINEMA
- 7CH STEREO
- WIDE SCREEN
- SUPER STADIUM
- ROCK ARENA
- JAZZ CLUB
- CLASSIC CONCERT
- MONO MOVIE
- VIDEO GAME
- MATRIX

### Source Select

(page 42 ~ 46)

- DVD, HDP, TV/CBL, SAT, VCR, DVR-1, DVR-2, V.AUX, CD, TUNER
  - Play (iPod)
  - Playback Mode (iPod)
  - Assign
    - HDMI
    - Digital
    - Component
    - Analog (CD only)
    - iPod dock
  - Video
    - Video Select
    - Video Convert  
(Excluding CD and TUNER)
    - i/p Scaler
    - Resolution
    - Progressive Mode  
(Excluding CD and TUNER)
    - Aspect  
(Excluding CD and TUNER)
  - Input Mode
  - Rename
  - Source Level
  - Input Att.
- NET/USB
  - Play
  - Playback Mode
  - Still Picture
  - Video
    - Video Select
    - i/p Scaler
    - Resolution
  - Input Mode
  - Rename
  - Source Level
- PHONO
  - Video
    - Video Select
    - i/p Scaler
    - Resolution
  - Input Mode
  - Rename
  - Source Level
  - Input Att.

### Auto Setup

(page 25 ~ 27)

- Auto Setup
  - STEP1: Speaker Detection
  - STEP2: Measurement
  - STEP3: Calculation
  - STEP4: Check
  - STEP5: Store
- Option
  - Room EQ
  - Direct Mode
  - Mic Select
- Parameter Check
  - Speaker Configuration Check
  - Distance Check
  - Channel Level Check
  - Crossover Check
  - EQ Check
  - Restore

### Manual Setup

(page 28 ~ 42)

- Speaker Setup (page 28 ~ 30)
  - Speaker Configuration
  - Subwoofer Setup
  - Distance
  - Channel Level
  - Crossover Frequency
  - THX Audio Setup
  - Surround Speaker
- HDMI Setup (page 31)
  - Color Space
  - RGB Range
  - Auto Lip Sync
  - Audio
  - Monitor Out
  - HDMI Control
- Audio Setup (page 32, 33)
  - EXT. IN Setup
    - Mode
    - Surround Back Input
    - Surround Speaker
    - Subwoofer Level
    - Input Att.
  - 2ch Direct/Stereo
  - Downmix Option
  - Auto Surround Mode
  - Manual EQ
- Network Setup (page 34 ~ 36)
  - Network Setup
  - Other
    - Power Saving
    - Character
    - PC Language
  - Network Information
- Zone Setup (page 36, 37)
  - ZONE2, ZONE3
    - Bass
    - Treble
    - HPF
    - Lch Level
    - Rch Level
    - Channel
    - Volume Level
    - Volume Limit
    - Power On Level
    - Mute Level
    - Video Convert (ZONE2 only)
  - OSD
- Option Setup (page 37 ~ 41)
  - Pre-out Assign
  - XLR Out Polarity
  - POA Setting
  - Volume Control
    - Volume Limit
    - Power On Level
    - Mute Level
  - Source Delete
  - GUI
    - Screensaver
    - Wall Paper
    - Format
    - Text
    - Master Volume
  - NET/USB / iPod
  - Quick Select Name
  - Trigger Out 1
  - Trigger Out 2
  - Trigger Out 3
  - Trigger Out 4
  - Transducer Setup
  - Digital Out
  - Remote ID
  - 2Way Remote
  - Dimmer
  - Setup Lock
  - Maintenance Mode
  - Firmware Update
  - Add New Feature
- Language (page 42)

When "Screensaver" is set to "ON", the screensaver is activated if no operation is performed for about 3 minutes.

# Auto Setup



- Audyssey MultEQ® XT automatically measures the acoustical problems in the listening environment to create the best audio experience for your home theater.
- It optimizes a large listening area where one or more listeners are seated.

Measurements are performed by placing the calibrated microphone (DM-A505Z) successively at multiple positions throughout the listening area as shown in **Example ①**. For best results, it is strongly recommended to measure 6 or more positions so that the measurements have the proper spatial weighting.

Even if the listening environment is small as shown in **Example ②**, measuring at multiple points throughout the listening environment results in more effective correction.

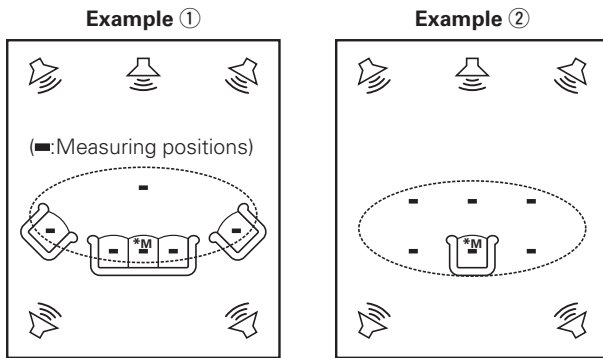

### About the main listening position (\*M)

The main listening position refers to the most central position where one would normally sit within the listening environment. MultEQ XT uses the measurements from this position to calculate speaker distance, level, polarity, and the optimum crossover value for the subwoofer.



To make manual adjustments to the settings, see pages 28 ~ 30.

## Preparations

- 1 Connect the included calibrated setup microphone to the SETUP MIC jack on the main unit.**  
The "Auto Setup" screen appears automatically.

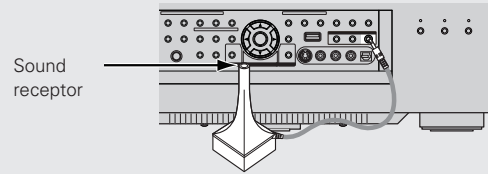

- 2 Place the microphone at ear height on a tripod or stand with the microphone pointing directly up towards the ceiling.**

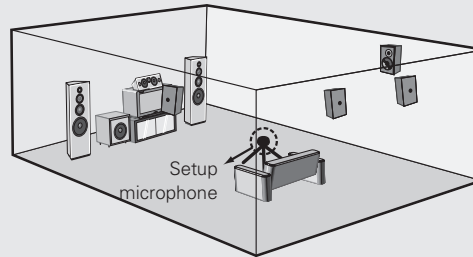

※ It is not recommended to hold it in your hand. Be sure that the path from microphone to the speakers is not blocked by objects. Avoid placing the microphone close to a seat back or wall as sound reflections may give inaccurate results.



When using a subwoofer, make the following settings before starting the auto setup procedure:

- Defeat the volume and crossover controls if possible
- If this is not possible then set
  - Volume: "12 o'clock" position
  - Crossover frequency: "Maximum/Highest Frequency"
  - Low pass filter: "Off"
  - Standby mode: "Off"

### NOTE

- Do not disconnect the setup microphone until the auto setup procedure is completed.
- When using headphones, unplug the headphones before starting the auto setup procedure.

## Auto Setup

Optimize settings for speakers in use.



### Menu tree



### 1 Auto Setup

The settings are performed automatically.



#### [Auto setup flow]

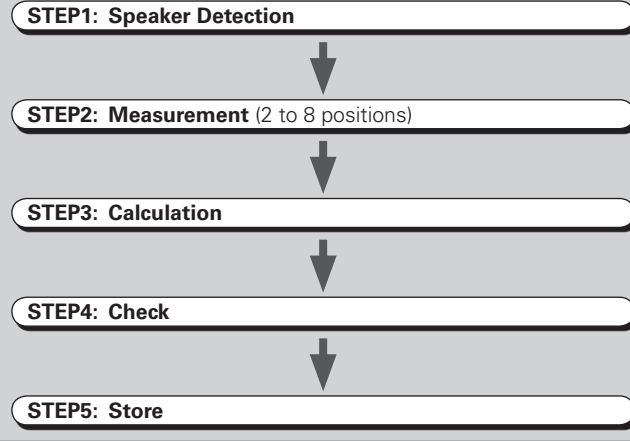

## Start

Start Auto Setup.

The Audyssey MultEQ XT Auto Setup process automatically calculates the size, level, distance, bass management crossover frequency, and optimal settings for each speaker and subwoofer. Audyssey MultEQ XT corrects acoustical distortions within the listening area.

Before starting, connect and position all your speakers.

Once started, MultEQ XT will play a series of test tones through each speaker.



If an error message appears during the measurements, check “Error Messages” (page 27), take the advised action, then start the measurements again.

## Configuration

The speaker system to be measured can be selected ahead of time here.

[Selectable items]	9.1 *1	7.1 *1	5.1 *1
	9.2 *2	7.2 *2	5.2 *2
	9.3 *3	7.3 *3	5.3 *3

\*1: This can be set when “Subwoofer” is set to “1SP”

\*2: This can be set when “Subwoofer” is set to “2SP L/R” or “2SP MIX”

\*3: This can be set when “Subwoofer” is set to “3SP L/R/LFE” or “3SP MIX”



Setting the correct speaker configuration can reduce the time required to measure during the auto setup procedure as the system will not have to look for speakers that are not connected.

## Subwoofer

The configuration of the measuring subwoofer can be selected beforehand.

[Selectable items]	1SP	2SP L/R	2SP MIX
	3SP L/R/LFE	3SP MIX	

## Pre-out Assign

Change the pre-out assignment.

[Selectable items] **Normal** **Free Assign**

## XLR Out Polarity

Set to switch the XLR pre-out terminal polarity.

[Selectable items] **XLR** **XLR (INV)**



Set each channel.

## STEP1 : Speaker Detection

The speaker connection and polarity are detected at the first measurement position. The following attributes are also determined at this time: “Speaker Size,” “Speaker Distance,” “Channel Level,” “Crossover Frequency.”

Once the measurements are completed, the results are displayed.

### NOTE

- Loud test tone may be played during Audyssey MultEQ XT Automatic Speaker Setup. This is part of normal operation. If there is background noise in room, these test tones will increase in volume.
- Do not stand between the speakers and setup microphone or allow obstacles in the path while the measurements are being made. This will cause inaccurate readings.
- Quiet the listening environment before beginning measurements and refrain from talking. Turn off air conditioning units or other devices that emit noise if at all possible as measurements may be affected by these sounds.
- Operating the **MASTER VOLUME** knob on the main unit or the **VOL +/-** buttons on the remote control unit during the measurements will cancel the measurements.
- Do not change the speaker connections or subwoofer volume after “STEP1.”

## STEP2: Measurement

After completing a measurement position, move the microphone to the next position.



Measure at least 6 positions (main listening position and at least 5 other surrounding positions). For best results it is recommend measuring **6 or more positions** (with a maximum of 8 positions).

## STEP3: Calculation

When “Calculate” is selected at “STEP2,” the measurements taken are analyzed automatically to determine how the speaker system interacts with the room.



The time required for this analysis depends on the number of speakers connected. The higher the number of speakers, the longer the time required for analysis.

## STEP4: Check

Once the auto setup procedure is complete, a measuring result check screen appears.

Select any item whose results you want to check to review the results.



Values that are different from the actual distance may be set for speakers with built-in filters (subwoofers, etc.). This is because filters add electrical delay to the signal that should be compensated.

## STEP5: Store

The auto setup measurement results are stored in the AVP-A1HD.

### NOTE

Do not turn the power off while the settings are being stored.

## Error Messages

If the auto setup procedure could not be completed due to speaker installation, the measuring environment, etc., an error message is displayed. If this happens, check the relevant items, be sure to take the necessary measures, then perform the auto setup procedure over again.

Error messages (examples)	Cause	Measures
<b>No microphone or speaker</b>	<ul style="list-style-type: none"> <li>Included setup microphone is not connected.</li> <li>Not all speakers could be detected.</li> <li>The front L speaker was not properly detected.</li> </ul>	<ul style="list-style-type: none"> <li>Connect the included setup microphone to the <b>SETUP MIC</b> jack on the main unit.</li> <li>Check the speaker connections.</li> </ul>
<b>Ambient noise is too high or Level is too low</b>	<ul style="list-style-type: none"> <li>Too much noise in the room for accurate measurements to be made.</li> <li>Speaker or subwoofer sound is too low for accurate measurements to be made.</li> </ul>	<ul style="list-style-type: none"> <li>Either turn off any device generating noise or move it away.</li> <li>Try again when the surroundings are quieter.</li> <li>Check the speaker installation and the direction in which the speakers are facing.</li> <li>Adjust the subwoofer's volume.</li> </ul>
<b>None</b>	<ul style="list-style-type: none"> <li>Displayed speaker could not be detected.                             <ul style="list-style-type: none"> <li>The front R speaker was not properly detected.</li> <li>Only one channel of the surround (A) and surround (B) speakers was detected.</li> <li>Sound was output from the R channel when only one surround back speaker was connected.</li> <li>The surround back or the surround (B) speaker was detected, but the surround (A) speaker was not detected.</li> <li>When the subwoofer configuration is set at "2SP L/R", "2SP MIX", "3SP L/R/LFE" or "3SP MIX", the subwoofer could not be detected.</li> </ul> </li> </ul>	<ul style="list-style-type: none"> <li>Check the connections of the displayed speaker.</li> </ul>
<b>Phase</b>	<ul style="list-style-type: none"> <li>Displayed speaker connected with the polarities reversed.</li> <li>If the XLR pre-out terminal is used, the polarity is reversed.</li> </ul>	<ul style="list-style-type: none"> <li>Check the polarities of the displayed speaker.</li> <li>Check the polarity setting for the XLR output of the displayed pre-set channel.</li> <li>For some speakers, this error message may be displayed even if the speaker is properly connected. If you are sure that the wiring is correct, select "Skip".</li> </ul>

- Sometimes due to the electrical complexities of subwoofers and the interaction with the room, THX recommends setting the level and the distance of the subwoofer manually.
- Sometimes due to interaction with the room, you may notice irregular results when setting the level and/or distance of the main speakers. If this happens, THX recommends setting them manually.
- Please note that any THX main speakers should be set to Small (80 Hz). If you set up your speakers using Auto Setup, please make sure manually that any THX speakers are set to Small with 80 Hz crossover.

 Select "Retry" to make the measurements again.

**NOTE** Be sure to turn the power off before checking the speaker connections.

## 2 Option

Select settings for room EQ, mic, etc.



### Room EQ

Select room EQ setting method.

[Selectable items] **All** **Assign**

### Direct Mode

Select room EQ use for DIRECT or PURE DIRECT mode.

[Selectable items] **ON** **OFF**

### Mic Select

Select the microphone type if not using supplied mic. The microphone connected to V.AUX Lch is used.

[Selectable items] **Mic** **V.AUX L**



Only a professionally certified installer should ever connect a professionally-calibrated microphone to the V.AUX L input on the front panel.

## 3 Parameter Check

Check auto setup measurement results. This is displayed after the auto setup procedure is completed.



[Selectable items]

**Spkr Config Check** **Distance Check** **Ch. Level Check**

**Crossover Check** **EQ Check** **Restore**



The auto setup results can be reset to what was originally calculated by MultEQ XT when "Restore" is selected.

# Manual Setup



Make detail settings for various parameters.

## Speaker Setup

Use this procedure to set the speakers manually or if you wish to change the settings made with the auto setup procedure.



### Menu tree

Manual Setup

#### Speaker Setup

- 1 Speaker Configuration
- 2 Subwoofer Setup
- 3 Distance
- 4 Channel Level
- 5 Crossover Frequency
- 6 THX Audio Setup
- 7 Surround Speaker

## 1 Speaker Configuration

Select speaker configuration and size. (bass reproduction capability)

### Front

Select front speaker size.

[Selectable items] **Large** **Small**

### Center

Select center speaker use and size.

[Selectable items] **Large** **Small** **None**

### Subwoofer

Select subwoofer use.

[Selectable items] **Yes** **No**

### Surround A

Select surround speakers A use and size.

[Selectable items] **Large** **Small** **None**

### Surround B

Select surround speakers B use and size.

[Selectable items] **Large** **Small** **None**

### Surround Back

Select surround back speaker use and size.

[Selectable items] **Large** **Small** **None**  
**2spkrs** **1spkr**

**Large** : Select this for a large speaker with strong bass reproduction.

**Small** : Select this for a smaller speaker with weaker bass reproduction.



- Select "Large" or "Small" not according to the physical size of the speaker but according to the low frequency reproduction capabilities based on the frequency set at "Crossover Frequency" (page 29, 30).
- When "Front" is set to "Small", "Subwoofer" is automatically set to "Yes".
- If "Subwoofer" is set to "No", "Front" is automatically set to "Large".
- If "Surround A" is set to "None", "Surround B" and "Surround Back" are automatically set to "None".
- When using just one surround back speaker, connect it to the left channel (SBL).
- To take full advantage of the performance of the Home THX certified speaker systems, set the front, center and surround speaker size parameters to "Small" and the subwoofer to "Yes".

## 2 Subwoofer Setup

Select subwoofer output configuration and bass signal for playback.

### Configuration

Select number of subwoofers and configuration.

[Selectable items]

**1SP** **2SP L/R** **2SP MIX** **3SP L/R/LFE** **3SP MIX**

Subwoofer Configuration	Subwoofer Connector	
1SP		SW1
2SP L/R	L	SW1
	R	SW2
2SP MIX	1	SW1
	2	SW2
3SP L/R/LFE	L	SW1
	R	SW2
	LFE	SW3
3SP MIX	1	SW1
	2	SW2
	3	SW3



When "2SP MIX" or "3SP MIX" is selected, "Subwoofer 1", "Subwoofer 2" and "Subwoofer 3" are each displayed.

### Mode

Select bass signal for playing with the subwoofer.

[Selectable items] **LFE-THX-** **LFE+Main**



- THX recommends LFE-THX- mode so that bass interference is less likely to occur in the room.
- This can be set when the GUI menu "Speaker Configuration" – "Subwoofer" is set to "Yes".
- Play music or a movie source and select the mode offering the strongest bass.
- Select "LFE+Main" if you want the bass signals to always be produced from the subwoofer.



### 3 Distance

Set distance from listening position to speakers.  
Before making the settings, measure the distance from the listening position to the different speakers.

#### Meters / Feet

Select unit for distance.

#### Step

Select step. (smallest distance)

#### [Selectable items]

**0.1m** **0.01m** : Can be selected when "Meters" is set.

**1ft** **0.1ft** : Can be selected when "Feet" is set.

#### Default

Resets the settings to the default values.

#### Distance measurement

Select the speaker you want to set, then set the distance.  
Set the value closest to the measured distance.

#### [Variable range]

**0.00m ~ 18.00m** : Display when "Meters" is set.

**0.0ft ~ 60.0ft** : Display when "Feet" is set.



Two surround back speakers are required to use the THX Ultra2 Cinema, THX Music mode and THX Games mode.

Set the surround back speakers so that the distance to the listening position is the same for both the left and right speakers.

It is also recommended that the deviations of the distance from the listening position to L and R channel speakers (front left (FL) and front right (FR), surround left (SL) and surround right (SR), surround back left (SBL) and surround back right (SBR) is less than 60 cm (2 ft).

#### NOTE

Set the distance between the listening position and the various speakers to no more than 6.00 meters (20 ft).

### 4 Channel Level

Adjust channel levels to obtain equal volume from all speakers.

#### Mode

Select test tone playback method.

[Selectable items] **Auto** **Manual**

#### Surround

Select surround speaker from which test tone is output.

[Selectable items] **A** **B** **A+B**

#### Start

Output test tone.

[Variable range] **OFF** \* **-12dB** ~ **0dB** ~ **+12dB**

\*: "OFF" can be set by pressing ◀ when the subwoofer's volume is set to -12 dB.

#### Default

Resets the settings to the default values.



#### Operating from the main remote control unit

Adjusting with the main remote control unit using the test tones is only possible in the "Auto" mode and only effective in the STANDARD (Dolby/DTS Surround) and HOME THX CINEMA modes. The adjusted levels for the different modes are automatically stored in the memory.

#### [Adjusting using test tones]

- ① Press the **TEST** button.  
Test tones are output from the various speakers.
- ② Use the ◀ ▶ button to adjust so that the volume is equal for all speakers.
- ③ When the adjustments are completed, press the **TEST** button again.



- The level of each channel should be adjusted to 75 dB (Cweighted, slow meter mode) on a sound level meter at the listening position. If a sound level meter is not available adjust the channels by ear so the sound levels are the same. Because adjusting the subwoofer level test tone by ear is difficult, use a well known music selection and adjust for natural balance.
- When the GUI menu "Speaker Configuration" – "Surround Back" setting (page 28) is set to "1spkr", the surround back speaker display is set to "Surround Back".
- Speakers set to "None" in the "Speaker Configuration" settings are not displayed.
- "Surround" can be set when GUI menu "Speaker Configuration" – "Surround B" is set to "Large" or "Small" (page 28).
- When using surround speakers, be sure to adjust the volume of the different speakers.
- When "Channel Level" is adjusted, the adjusted values are set for all the surround modes. To adjust the channel level separately for the different surround modes, use the operation see page 65.

### 5 Crossover Frequency

Select crossover frequency from which subwoofer handles low range signal.

#### [Selectable items]

**FIXED-THX-** :

Setup when using a THX-certified speaker.

**40Hz** **60Hz** **80Hz** **90Hz** **100Hz** **110Hz** **120Hz** **150Hz**  
**200Hz** **250Hz** :

Only the portion of the bass sound of the various speakers output from the subwoofer that has a frequency below the frequency set here is output.

Set this according to the low frequency reproduction capabilities of the speakers you are using.

**Advanced** :

Specify crossover frequency for each speaker.



- Please set all THX Certified speakers, set the “Speaker Configuration” for all speakers to “Small”. We recommend using with the crossover frequency set to “FIXED-THX-”, but depending on the speaker, setting it to a different frequency may improve frequency response near the crossover frequency.
- The “Crossover Frequency” can be set when there are speakers that have been set to “Small” at GUI menu “Speaker Configuration” or when “Subwoofer” is set to “Yes” (page 28).
- At the “Advanced” settings, if the “Subwoofer Setup” (page 28) setting is set to “LFE-THX-”, GUI menu speakers for which “Speaker Configuration” is set to “Small” can be set. If set to “LFE+Main”, the setting can be made regardless of the speaker size.
- For speakers set to “Small”, sound below the crossover frequency is cut from the sound output. The cut bass sound is output from the subwoofer or front speakers.

## 6 THX Audio Setup

Set the speaker to play the optimal THX surround mode.

### THX Ultra2 Subwoofer

Set when using a subwoofer compatible with THX Ultra2 standards or a subwoofer that can be properly played at low range.

[Selectable items] **Yes** **No**



Make these settings when “Yes” is selected for the subwoofer in the “Speaker Configuration” settings. This option is not available when “No” is selected (page 28).

### BGC (Boundary Gain Compensation)

If bass sound feels big compensate by lowering volume.

[Selectable items] **ON** **OFF**



- If the bass sound seems too strong:  
Set “BGC” to “ON”. This activates a filter that gently reduces very deep bass below 55 Hz to provide the flattest overall deep bass response. Select “ON” or “OFF” according to how strong you prefer the deep bass response to be.
- This can be set when the “THX Ultra2 Subwoofer” setting is set to “Yes”.

### SB Speaker Position

Set the distance between the left and right surround back speakers.

[Selectable items] **Under 0.3m** **0.3m – 1.2m** **Over 1.2m**



- When two surround back speakers have been set in “Speaker Configuration” (page 28), set the distance of the speakers. This option is not available when “1spkr” is selected.
- This setting is necessary to achieve the optimum effect in the THX Surround EX, THX Ultra2 Cinema, THX Music mode and THX Games mode.

## 7 Surround Speaker

Select surround speakers to use for each surround mode.

### THX/DOLBY/DTS Cinema

[Selectable items] **A** **B** **A+B**

### THX/DOLBY/DTS Music

[Selectable items] **A** **B** **A+B**

### THX/DOLBY Game

[Selectable items] **A** **B** **A+B**

### WIDE SCREEN

[Selectable items] **A** **B** **A+B**

### 7CH STEREO

[Selectable items] **A** **B** **A+B**

### DSP SIMULATION

[Selectable items] **A** **B** **A+B**

### MULTI CH MODE

[Selectable items] **A** **B** **A+B**



### Operating from the main remote control unit

Press the **SPKR** button.



- This can be set when GUI menu “Speaker Configuration” – “Surround A” and “Surround B” are used (page 28).
- Make the surround speaker settings when the input mode is set to “EXT. IN” at GUI menu “Manual Setup” – “Audio Setup” – “EXT. IN Setup” (page 32).

### About Speaker Type Setting when Using Both Surround speakers A and B

If “Small” is set for either surround speakers A or B, the output is the same as when “Small” is set for both A and B.

## HDMI Setup

Make settings for HDMI video/audio output.

GUI



### Menu tree

#### Manual Setup

#### HDMI Setup

1 Color Space

2 RGB Range

3 Auto Lip Sync

4 Audio

5 Monitor Out

6 HDMI Control

### 1 Color Space

Make settings for output color space.

[Selectable items] **YCbCr** RGB



When connected to a monitor with a DVI-D connector (HDCP compatible) using an HDMI/DVI converter cable, the signals are output in RGB format, regardless of this setting.

### 2 RGB Range

Make settings for RGB output range.

[Selectable items] **Normal** Enhanced



When "YCbCr" is selected under "Color Space," "RGB Range" will have no effect.

### 3 Auto Lip Sync

Automatic compensation for timing shift in audio and video output.

[Selectable items] **ON** OFF

### 4 Audio

Select HDMI audio output device.

[Selectable items] **Amp** TV



GUI menu "HDMI Control"- "Control" is "ON"; the "Amp" and "TV" will switch with the operation of any television not related to this setting.

### 5 Monitor Out

Make settings for HDMI monitor output.

[Selectable items] **Auto (Dual)** Monitor 1 Monitor 2



#### Operating from the main remote control unit

Press the **M.SEL** button.

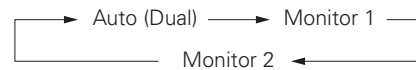

- When "Monitor Out" is set to "Auto (Dual)," connections with the MONITOR 1 or MONITOR 2 connectors are recognized automatically.
- If both the MONITOR 1 and 2 connectors are connected and "Resolution" is set to "Auto" (page 45), the signals are output with a resolution compatible with both monitors.
- If "Resolution" is set to something other than "Auto," check the resolutions with which your monitor is compatible at GUI menu "Information" – "HDMI Information" – "Monitor 1" and "Monitor 2" and set accordingly (page 53).

### 6 HDMI Control

Make settings for HDMI control function.

#### Control

Set HDMI control function ON/OFF.

[Selectable items] **ON** OFF

#### Control Monitor

Select the interlocking monitor with the HDMI control.

[Selectable items] **Monitor1** Monitor2



This can be set when "Control" is set to "ON".

#### Power Off Control

Interlock power OFF with HDMI control.

[Selectable items] **ON** OFF



- This can be set when "Control" is set to "ON".
- Please consult the operating instructions for each connected device to check the settings.

#### NOTE

- When the "Control" setting has been changed, always turn off the power to the connecting devices afterwards and then turn back on.
- The HDMI control function does not work when the power to the equipment is off.
- For details, see "HDMI Control Function" (page 63).

## Audio Setup

Make settings for audio playback.

**GUI**

● Menu tree ●

**Manual Setup**

- Audio Setup
  - 1 EXT.IN Setup**
  - 2 2ch Direct/Stereo**
  - 3 Downmix Option**
  - 4 Auto Surround Mode**
  - 5 Manual EQ**

### 1 EXT. IN Setup

Setup playback method for analog signals inputted from external input connectors (EXT. IN).

### Mode

Select playback mode.

[Selectable items] **DSP** **Analog**

### Surround Back Input

Select surround back channel input in combination with the connected player.

[Selectable items] **Not Used** **SBL/SBR** **SB(SBL)**

This can be set when "Mode" is set to "DSP".

### Surround Speaker

Select the surround speakers to use.

[Selectable items] **A** **B** **A+B**

This can be set when "Mode" is set to "Analog".  
 This can be set when GUI menu "Speaker Setup" – "Speaker Configuration" – "Surround A" and "Surround B" are used (page 28).

### Subwoofer Level

Set the subwoofer level for playback. Select according to the player in use.

[Selectable items] **0dB** **+5dB** **+10dB** **+15dB**

We recommend setting to "+15 dB".

### Input Att.

Setup when input level is too large and playback volume is distorted.

[Selectable items] **OFF** **-6dB**

This can be set when "Mode" is set to "DSP".

### 2 2ch Direct/Stereo

Make speaker settings for 2-channel mode playback.

### Setting

To change the settings, select "Custom".

[Selectable items] **Basic**\* **Custom**

\*: Use the same settings as in "Speaker Setup".

### Front

Select front speaker size.

[Selectable items] **Large** **Small**

### Subwoofer

Select subwoofer use.

[Selectable items] **Yes** **No**

### Subwoofer Mode

Select low range signal to be reproduced by subwoofer.

[Selectable items] **LFE-THX-** **LFE+Main**

### Crossover

Select crossover frequency from which subwoofer handles low range signal.

[Selectable items] **THX** **40Hz** **60Hz** **80Hz** **90Hz** **100Hz** **110Hz** **120Hz**  
**150Hz** **200Hz** **250Hz**

### Distance FL

Set distance from listening position to front left speaker.

[Variable range] **0.00m ~ 18.00m**

### Distance FR

Set distance from listening position to front right speaker.

[Variable range] **0.00m ~ 18.00m**

### 3 Downmix Option

Set dynamic range for downmix playback of Dolby Digital sources.

[Selectable items]  ON  OFF



- Set this to "ON" if the sound from the front speakers seems distorted.
- When not using the center speaker or surround speakers, the playback sound is down-mixed and output from the front speakers.

### 4 Auto Surround Mode

Make setting for memorizing surround mode setting for each input signal type.

[Selectable items]  ON  OFF



- The auto surround mode function lets you store in the memory the surround mode last used for playing the four types of input signals listed below.
  - ① Analog and PCM 2-channel signals
  - ② Dolby Digital and DTS 2-channel signals
  - ③ Dolby Digital and DTS multi-channel signals
  - ④ Multi-channel signals other than Dolby Digital and DTS (PCM, DSD, etc.)
- When playing in the PURE DIRECT mode, the surround mode does not change even if the input signal is changed.

### 5 Manual EQ

Adjust tonal quality for each speaker using graphic equalizer.

#### Adjust CH

Select speaker adjustment method.

[Selectable items]  Each  L/R  All

Select the speaker and frequency band and adjust the level.

[Selectable items]

63Hz  125Hz  250Hz  500Hz  1kHz  2kHz  4kHz  8kHz

16kHz

[Variable range]

-20dB ~  0dB ~  +6dB

#### Curve Copy

Copy the Room EQ's "Audyssey Flat" correction curve.

[Selectable items]  Yes  No



"Curve Copy" is displayed after the auto setup procedure has been performed.

#### Default

Resets the settings to the default values.

## Network Setup

Make network settings.

**GUI**

● Menu tree ●

- Manual Setup
  - Network Setup
    - 1 Network Setup
    - 2 Other
    - 3 Network Information

# 1 Network Setup

Make settings for wired or wireless LAN.

## Wired LAN settings

Make settings for wired LAN.

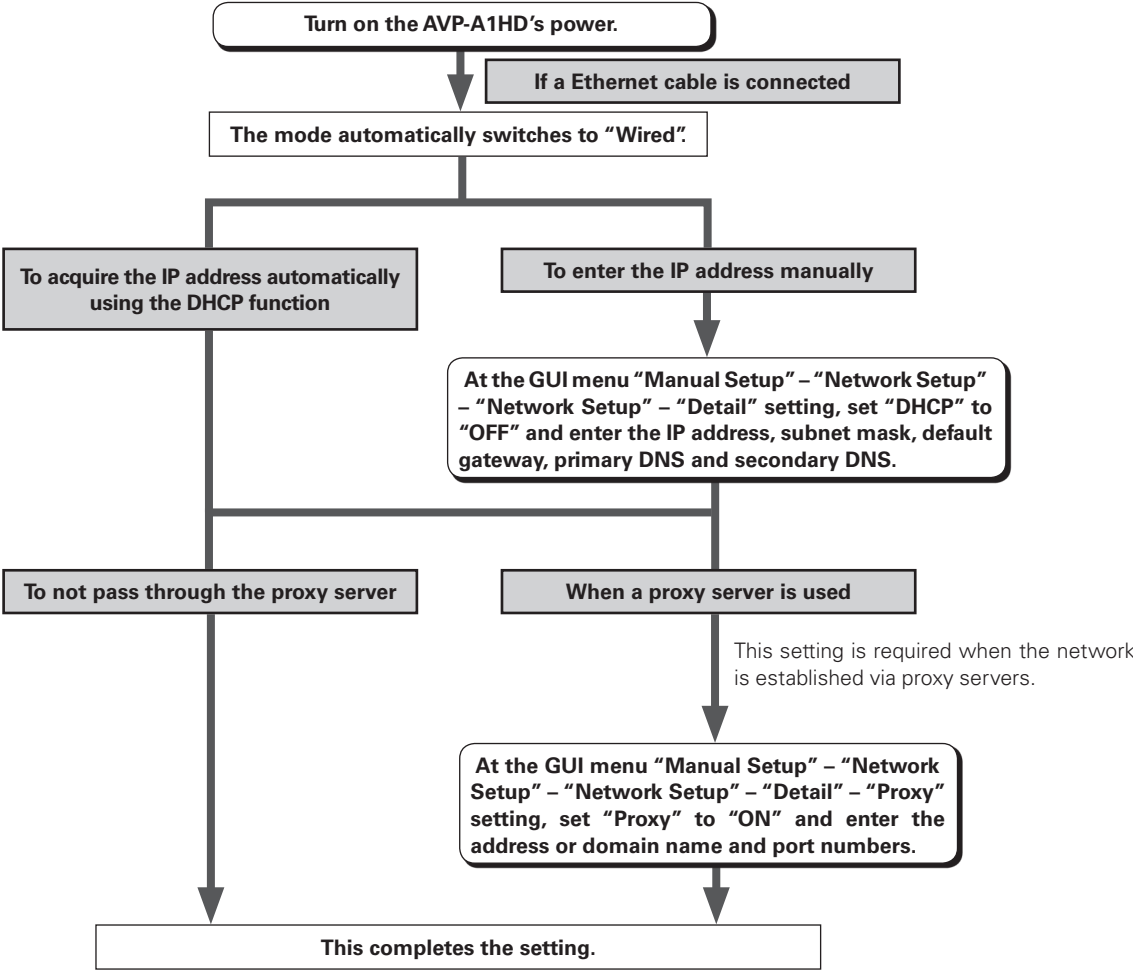

🔧 Recheck the connections and settings if you cannot connect to the Internet (🔧 page 20).

**NOTE** Knowledge about networks is required to make the IP address and proxy settings. For details, consult a network administrator.

## Wireless LAN settings

Make settings for wireless LAN.

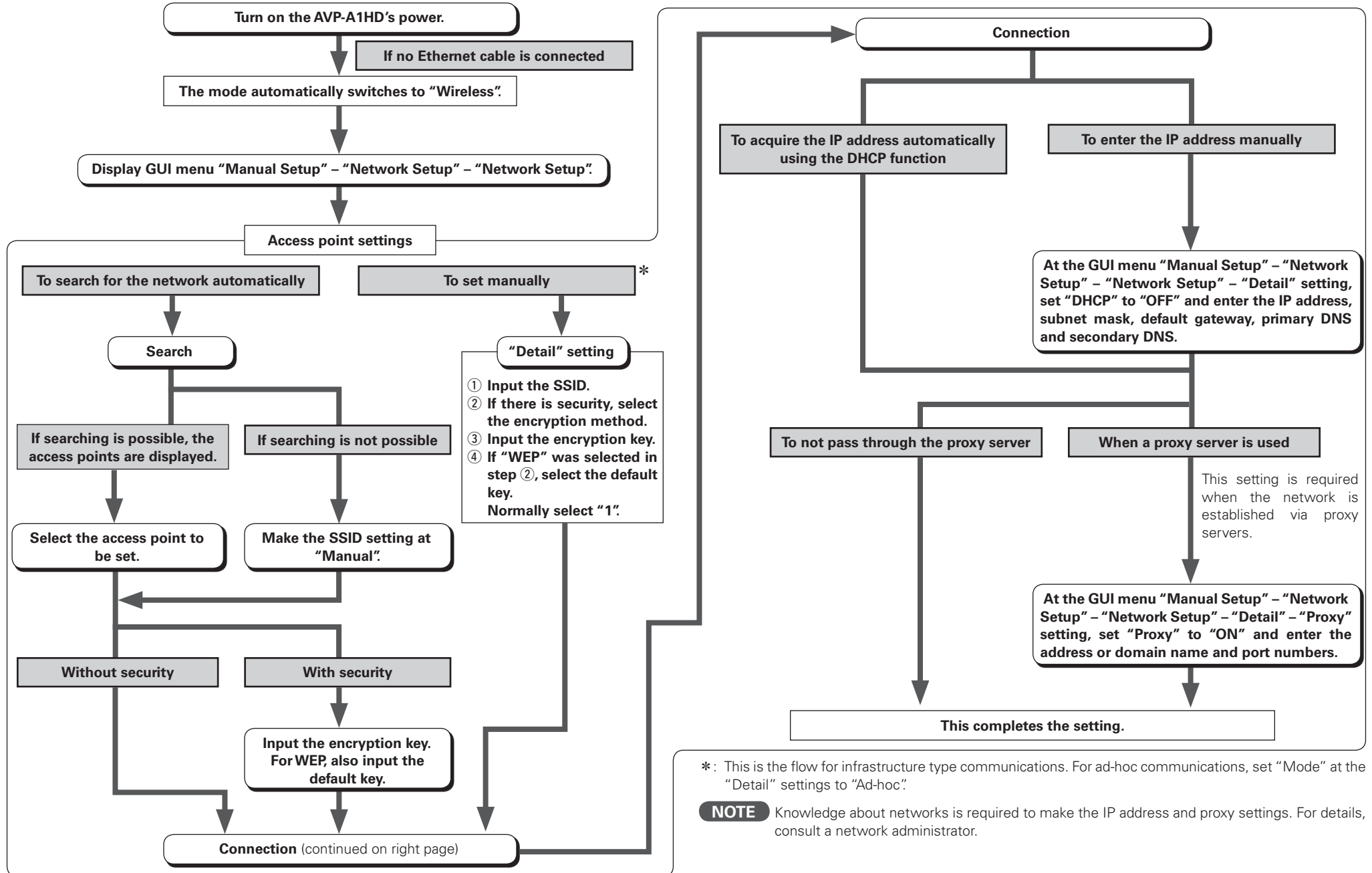

## 2 Other

Make setting for amp power save mode and computer language environment.

### Power Saving

Make setting for power saving when not connected to network.

[Selectable items]  ON  OFF



To use the web control function, set this setting to "OFF".

### Character

Set the character code type of the MP3 ID3-Tag played by USB.

[Selectable items]  Auto  Latin  Japanese



If the characters are not properly displayed when set to "Auto", set to "Latin" or "Japanese".

### PC Language

Select computer environment language.

[Selectable items]

ara  chi (smp)  chi (trad)  cze  dan  dut  eng  fin  
 fre  ger  gre  heb  hun  ita  jpn  kor  nor  pol  
 por  por (BR)  rus  spa  swe  tur

## 3 Network Information

Display network information.

[Items to be checked]

Wired or Wireless  SSID  DHCP= ON or OFF  IP Address

MAC Address

## Zone Setup

Make settings for audio playback in a multi-zone system.



● Menu tree ●

Manual Setup

Zone Setup

1 ZONE2

2 ZONE3

3 OSD

### 1 ZONE2

Make settings for audio playback in a ZONE2 system.

### 2 ZONE3

Make settings for audio playback in a ZONE3 system.

### Bass

Adjust low frequency range (bass).

[Variable range]  -10dB ~  0dB ~  +10dB

### Treble

Adjust high frequency range (treble).

[Variable range]  -10dB ~  0dB ~  +10dB

### HPF

When using speakers that cannot satisfactorily play low frequencies, distortion of the bass sound can be reduced by setting "HPF" to "ON".

[Selectable items]  ON  OFF

### Lch Level

Adjust the left channel output level.

[Variable range]  -12dB ~  0dB ~  +12dB



The "Lch Level" and "Rch Level" can be set when "Channel" is set to "Stereo".

### Rch Level

Adjust the right channel output level.

[Variable range]  -12dB ~  0dB ~  +12dB

### Channel

Switch between stereo and mono output.

[Selectable items]  Stereo  Mono

### Volume Level

Adjust the main volume level.

[Selectable items]  Variable  -40dB  0dB



### Volume Limit

Make a setting for maximum volume.

[Selectable items] **OFF** **-20dB** **-10dB** **0dB**



This can be set when "Volume Level" is set to "Variable."

### Power On Level

Define the volume setting that is active when the power is turned on.

[Selectable items] **Last** **---dB** **-70dB ~ 18dB**



This can be set when "Volume Level" is set to "Variable."

### Mute Level

Set the amount of attenuation when muting is on.

[Selectable items] **Full** **-40dB** **-20dB**

### Video Convert (ZONE2 only)

Automatically convert video input signal to ZONE2 monitor output format.

[Input source]

**DVD** **HDP** **TV/CBL** **SAT** **VCR** **DVR-1** **DVR-2** **V.AUX**

[Selectable items] **ON** **OFF**

### 3 OSD

Set ZONE2 monitor as onscreen display Zone.

[Selectable items]

**ZONE2** : Display only ZONE2 operations.

**ZONE2/ZONE3** : Display ZONE2 and ZONE3 operations.

#### NOTE

On-screen display appears only on the ZONE2 monitor. It does not appear on the ZONE3 monitor.

## Option Setup

Make various other settings.



● Menu tree ●

Manual Setup

Option Setup

1 Pre-out Assign

2 XLR Out Polarity

3 POA Setting

4 Volume Control

5 Source Delete

6 GUI

7 Quick Select Name

8 Trigger Out 1

9 Trigger Out 2

10 Trigger Out 3

11 Trigger Out 4

12 Transducer Setup

13 Digital Out

14 Remote ID

15 2Way Remote

16 Dimmer

17 Setup Lock

18 Maintenance Mode

19 Firmware Update

20 Add New Feature

## 1 Pre-out Assign

Change the pre-out assignment.

Setting "Free Assign" allows you to freely assign each pre-out to any channel, depending on the environment used.

[Selectable items] **Normal** **Free Assign**

Preout terminal	FL	FR	C	SL (A)	SR (A)	SL (B)	SR (B)	SBL	SBR	SW1	SW2	SW3
Pre-out Assign												
Normal	FL	FR	C	SL (A)	SR (A)	SL (B)	SR (B)	SBL	SBR	SW1	SW2	SW3
Free Assign	FL	FL	FL	FL	FL	FL	FL	FL	FL	FL	FL	FL
	FR	FR	FR	FR	FR	FR	FR	FR	FR	FR	FR	FR
	C	C	C	C	C	C	C	C	C	C	C	C
	SL (A)	SL (A)	SL (A)	SL (A)	SL (A)	SL (A)	SL (A)	SL (A)	SL (A)	SL (A)	SL (A)	SL (A)
	SR (A)	SR (A)	SR (A)	SR (A)	SR (A)	SR (A)	SR (A)	SR (A)	SR (A)	SR (A)	SR (A)	SR (A)
	SL (B)	SL (B)	SL (B)	SL (B)	SL (B)	SL (B)	SL (B)	SL (B)	SL (B)	SL (B)	SL (B)	SL (B)
	SR (B)	SR (B)	SR (B)	SR (B)	SR (B)	SR (B)	SR (B)	SR (B)	SR (B)	SR (B)	SR (B)	SR (B)
	SBL	SBL	SBL	SBL	SBL	SBL	SBL	SBL	SBL	SBL	SBL	SBL
	SBR	SBR	SBR	SBR	SBR	SBR	SBR	SBR	SBR	SBR	SBR	SBR
	SW1	SW1	SW1	SW1	SW1	SW1	SW1	SW1	SW1	SW1	SW1	SW1
	SW2	SW2	SW2	SW2	SW2	SW2	SW2	SW2	SW2	SW2	SW2	SW2
	SW3	SW3	SW3	SW3	SW3	SW3	SW3	SW3	SW3	SW3	SW3	SW3



- Channels that are set up in the GUI menu "Speaker Setup" - "Speaker Configuration" to "None" can be set up, but will not generate output.
- Pre-out terminals in ZONE2 and ZONE3 can not be allocated.

## 2 XLR Out Polarity

Set to switch the XLR pre-out terminal polarity.

[Selectable channels]

**Front L** **Front R** **Center** **Surround A L** **Surround A R**

**Surround B L** **Surround B R** **Surround Back L**

**Surround Back R** **Subwoofer 1** **Subwoofer 2** **Subwoofer 3**

[Selectable items] **XLR**



- ① GROUND
- ② HOT
- ③ COLD

**XLR (INV)**



- ① GROUND
- ② COLD
- ③ HOT

## 3 POA Setting

Set when connecting the receiver to a POA-A1HD.

### POA LINK

Set when connecting the receiver to a POA-A1HD through a CONTROL LINK.

[Selectable items] **OFF** **ON (Single)** **ON (Dual)**

## POA 1/POA 2

Set POA-A1HD for which the MODE select switch is set to "1" or "2".



See the POA-A1HD operating instructions.

### Input Selector

Select the setup channel.

[Selectable items] **L1** **R1** **L2** **R2** **L3** **R3**  
**L4** **R4** **L5** **R5**

Select the connector input to be used for each channel.

[Selectable items] **RCA** **XLR** **OFF**

### Power Amp

Select the setup channel.

[Selectable items] **L1/L2** **L3/L4** **L5/R5** **R1/R2** **R3/R4**

Set the power amp usage for each channel.

[Selectable items] **NORMAL** **BI-AMP** **BRIDGE (BTL)**

## LINK Check

Check CONTROL LINK.

## 4 Volume Control

Set the MAIN ZONE volume setting.

## Volume Limit

Make a setting for maximum volume.

[Selectable items] **OFF** **-20dB** **-10dB** **0dB**

## Power On Level

This sets the volume set when the MAIN ZONE's power is turned on.

[Selectable items] **Last** **---dB** **-80dB ~ 18dB**

## Mute Level

This sets the amount of attenuation of the volume when the mute mode is set in the MAIN ZONE.

[Selectable items] **Full** **-40dB** **-20dB**

## 5 Source Delete

Remove input sources that are not used from the display.

[Selectable items] **ON** **Delete**

### NOTE

- Input sources being used in the various zones cannot be deleted.
- Input sources set to "Delete" cannot be selected from GUI menu "Source Select" or using the **SOURCE SELECT** knob on the main unit or **SOURCE SELECT** button on the remote control unit.

## 6 GUI

Make GUI related settings.

## Screensaver

Make screensaver settings.

Use the screensaver to prevent burn-in on the monitor screen.

When set to "ON", the screensaver is activated if there is no activity for about 3 minutes.

[Selectable items] **ON** **OFF**

## Wall Paper

Change the GUI background.

[Selectable items] **Picture** **Black** **Gray** **Blue**

## Format

Select the video output signal format to match the monitor.

[Selectable items] **PAL** **NTSC**

### NOTE

When a format other than the video format of the connected monitor is set, the picture will not be displayed properly. Use the procedure described below to change the video format.



## Operating from the main unit

※ The GUI menu is not displayed when performing this setting.

- ① Press and hold the **AUDIO DELAY** and **RETURN** buttons for at least 3 seconds.  
"Video Format" appears on the display.
- ② Use the < > button to make the setting.
- ③ Press the **ENTER**, **MENU** or **RETURN** button to complete the setting.

```
*Video Format
< PAL >
```

## Text

Text information display.

[Selectable items] **ON** **OFF**

## Master Volume

Master volume display during adjustment.

[Selectable items] **ON** **OFF**

## NET/USB / iPod

This sets the time the on-screen display is displayed when an operation is performed.

[Selectable items] **Always** **30s** **10s** **OFF**

## 7 Quick Select Name

Change "Quick Select" display name.  
Up to 16 characters can be input.

[Input characters]

**A ~ Z** **a ~ z** **0 ~ 9** **! " # % & ' ( ) \* + , - . / : ; < = > ? @ [ \ ] (space)**

### 8 Trigger Out 1

Select the conditions to turn on the trigger out 1 with respect to the zone, input source, surround mode, HDMI monitor, etc. For details about the trigger out function, see page 22.

### 9 Trigger Out 2

This sets the conditions to turn on the trigger out 2, in the same way as "Trigger Out 1" above.

### 10 Trigger Out 3

This sets the conditions to turn on the trigger out 3, in the same way as "Trigger Out 1" above.

### 11 Trigger Out 4

This sets the conditions to turn on the trigger out 4, in the same way as "Trigger Out 1" above.

[Selectable items] **ON** ---

### Setting with Respect to the Zone

When the power of the zone turned on/off, the trigger out turns on.

### Setting with Respect to the Input Source

When the input source set to on is selected, the trigger out turns on.



Associated with respect to the input source for zones set to "ON" at "Setting with Respect to the Zone".

### Setting with Respect to the Surround Mode

When the surround mode set to on is selected, the trigger out turns on.



This is effective when the "MAIN ZONE" has been set to "ON" for the "Setting with Respect to the Zone" and the input source which is set to "ON" has been selected for the "Setting with Respect to the Input Source".

### Setting with Respect to the Monitor

When the HDMI monitor set to on is selected, the trigger out turns on.



This is effective when the "MAIN ZONE" has been set to "ON" for the "Setting with Respect to the Zone" and the input source which is set to "ON" has been selected for the "Setting with Respect to the Input Source".

### 12 Transducer Setup

Set when using transducer.



The Transducer Setup can be accessed through GUI menu "Speaker Setup" - "Subwoofer Setup" is "1SP", "2SP L/R" or "2SP MIX". The transducer signal is outputted from "SW3".

### Level

#### [Variable range]

-12dB ~ **0dB** ~ +12dB :

Set the transducer level.

**OFF** :

Turn the transducer output off.



When you adjust "Level", the adjusted value is set for all surround modes. To adjust the level for individual surround modes, use "Channel Level" (page 65).

### LPF

Set the upper limit of the low frequency output to the transducer.

#### [Selectable items]

40Hz	60Hz	<b>80Hz</b>	90Hz	100Hz	110Hz	120Hz
150Hz	200Hz	250Hz				

### 13 Digital Out

Set usage of OPT4 OUT.

[Selectable items] **ZONE4 Select** **Rec Select**

#### NOTE

The ZONE4 operations cannot be performed when set to "Rec Select".

### 14 Remote ID

Set remote control ID. Match the ID setting of the remote control unit and the receiver.

[Selectable items] **1** **2** **3** **4**



- When changing the remote ID, also change the AMP, iPod and NET/DTU modes of the main remote control unit at the same time (page 69).
- When changing the remote ID, also change the sub remote control unit at the same time (page 74).

### 15 2Way Remote

Set when using the 2-way remote control unit.

[Selectable items] **Used** **Not Used**



When using a 2-way remote control unit (RC-7000CI and RC-7001RCI, sold separately), set this to "Used".

#### NOTE

- When using the 2-way remote control unit, connect to the Port 1 RS-232C connector.
- If GUI menu "Manual Setup" - "Option Setup" - "2Way Remote" is set to "Used", you cannot use port 1 of the RS-232C terminal for the external controller.

## 16 Dimmer

Adjust display brightness of the receiver.

[Selectable items] **Bright** **Dim** **Dark** **OFF**



### Operating from the main unit

Press the **DIMMER** button.



If POA-A1HD is connected using the control link, POA-A1HD meter operation is turned OFF when the AVP-A1HD display is turned "OFF".

## 17 Setup Lock

Protect settings from inadvertent change.

[Selectable items] **ON** **OFF**



- When "Setup Lock" is set to "ON", the settings listed below can no longer be changed. Also, "SETUP LOCKED!" is displayed if you attempt to operate related buttons.
  - GUI menu operations
  - RESTORER
  - Night Mode
  - Parameter
  - Room EQ
  - Channel Level
  - Audio Delay
- To cancel the setting, press the **MENU** button to re-display the "Setup Lock" screen, then change the setting to "OFF".

## 18 Maintenance Mode

This sets the function for maintenance by a DENON serviceperson or installer. (For professional use only.)

This function allows a DENON serviceperson or installer to check the AVP-A1HD's status and make settings via the Internet.

### NOTE

Only use this function if so instructed by a DENON serviceperson or installer.

## 19 Firmware Update

Update the firmware of the receiver.



If POA-A1HD is connected using the control link, POA-A1HD is updated simultaneously with update of AVP-A1HD.

### Check for Update

You can check for firmware updates. You can also check approximately how long it will take to complete an update.

### Start

Execute the update process.

When updating starts, the power indicator becomes red and the GUI screen is shut down.

The amount of update time which has elapsed is displayed during the update process.

When updating is complete the power indicator becomes green and normal status is resumed.

※ If the display reads as shown below, check the settings and network environment, then update again.

Display	Description
<b>Updating failed</b>	Updating failed.
<b>Login failed</b>	Failure to log into server.
<b>Server is busy</b>	Server is busy. Wait a while then try again.
<b>Connection fail</b>	Failure connecting to server.

## 20 Add New Feature

Display the new functions which can be purchased for downloading to the AVP-A1HD and upgrade.

When you purchase a new function and register your user information, "Registered" is displayed on this menu and you can proceed with the upgrade.

Upon completion of the upgrade, you can start using the new function.

### Upgrade

Execute the upgrade process.

When upgrading starts, the power indicator becomes red and the GUI screen is shut down.

The amount of upgrade time which has elapsed is displayed during the upgrade process.

When upgrading is complete the power indicator becomes green and normal status is resumed.

※ If the upgrade is not successful, an error message identical to those in "Firmware Update" will appear on the display.

### Notes concerning use of "Firmware Update" and "Add New Feature"

- In order to use these functions, you must have the correct system requirements and settings for a broadband Internet connection. For details, see pages 34 ~ 36.
- Do not turn off the power until updating or upgrading is completed.
- Normally there is no need to use this function, aside from the cases described below.
  - Firmware Update : In the case of applying the latest firmware updates (free)
  - Add New Feature : In the case of future upgrades to add new functions to the receiver (payment required)
  - Information regarding the "Firmware Update" function and "Add New Feature" will be announced on the DENON web site each time related plans are defined.
- Even with a broadband connection to the Internet, approximately 1 hour is required for the updating/upgrading procedure to be completed.
  - Once updating/upgrading starts, normal operations on the AVP-A1HD cannot be performed until updating/upgrading is completed.
  - Furthermore, updating/upgrading the firmware may reset the backup data for the parameters, etc., set for the AVP-A1HD.
- When updating/upgrading the firmware, we recommend using wired connections (Ethernet cable).

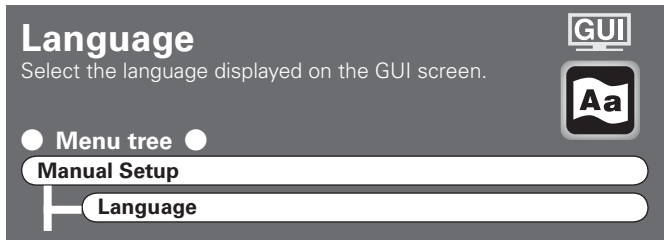

- Operating from the main unit**
- ※ The GUI menu is not displayed when performing this setting.
  - ① Press and hold the **AUDIO DELAY** and **RETURN** buttons for at least 3 seconds.  
"Video Format" appears on the display.
  - ② Use the  $\Delta$ / $\nabla$  button to set "GUI Language".
  - ③ Use the  $\triangleleft$ / $\triangleright$  button to make the setting.
  - ④ Press the **ENTER**, **MENU** or **RETURN** button to complete the setting.



Use this procedure to select the input source and make the settings related to playing input sources.

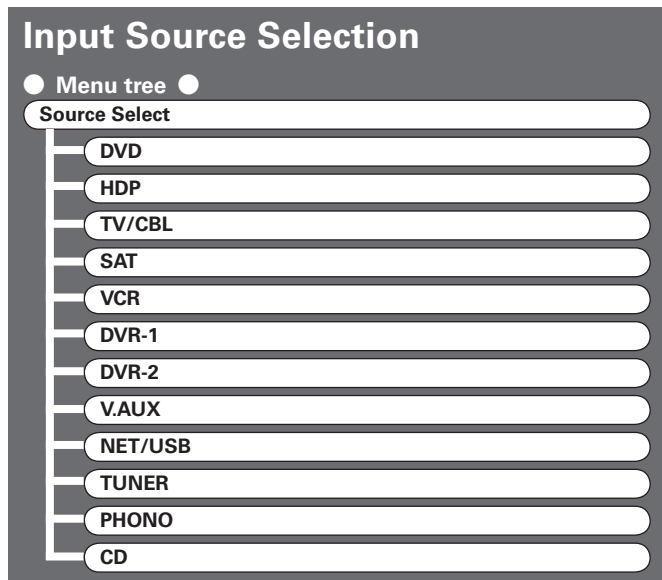

**Operating from the main unit or main remote control unit**

**[Operation on the main unit]**  
Turn the **SOURCE SELECT** knob.  
※ If "Rec Select" or "Video Select" is selected, press the **SOURCE** button before turning the **SOURCE SELECT** knob.

**[Operation on the main remote control unit]**  
Press the **SOURCE SELECT** button.  
The desired input source can be selected directly.

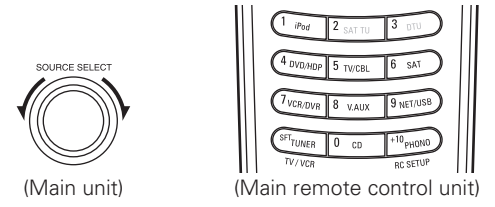

- To operate the AVP-A1HD using the main remote control unit, set the remote control unit to the AMP mode (page 66 "Remote Control Unit Operations").
- Pressing the **DVD/HDP** button and the **VCR/DVR** button on the main remote control will switch between the following.

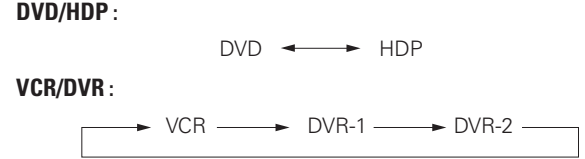

# Settings Related to Playing Input Sources



● Menu tree ●

Source Select

DVD, HDP, TV/CBL, SAT, VCR, DVR-1, DVR-2, V.AUX, TUNER, CD

- 1 Play\*
- 2 Playback Mode (iPod)\*
- 3 Assign
- 4 Video
- 5 Input Mode
- 6 Rename
- 7 Source Level
- 8 Input Att.

NET/USB

- 1 Play
- 9 Playback Mode
- 10 Still Picture
- 4 Video
- 5 Input Mode
- 6 Rename
- 7 Source Level

PHONO

- 4 Video
- 5 Input Mode
- 6 Rename
- 7 Source Level
- 8 Input Att.

## 1 Play

The playback screen is displayed.

[Input source] **NET/USB** ( **iPod** )

## 2 Playback Mode (iPod)

Make settings for "iPod" playback.

### Repeat

Make settings for repeat mode.

[Input source]

DVD HDP TV/CBL SAT VCR DVR-1 DVR-2 V.AUX  
TUNER CD

[Selectable items] **All** **One** **OFF**

### Shuffle

Make settings for shuffle mode.

[Input source]

DVD HDP TV/CBL SAT VCR DVR-1 DVR-2 V.AUX  
TUNER CD

[Selectable items] **Songs** **Albums** **OFF**



This can be selected for input sources for which "Assign" is assigned at the "iPod dock" setting.

## 3 Assign

Assign input sources to input connectors.

### HDMI

Select HDMI connector to assign to this source.

[Input source]

DVD HDP TV/CBL SAT VCR DVR-1 DVR-2 V.AUX

[Selectable items] **1** **2** **3** **4** **5** **6** **None**

Input source	DVD	HDP	TV/CBL	SAT
Default setting	<b>HDMI1</b>	<b>HDMI2</b>	None	<b>HDMI3</b>

Input source	VCR	DVR-1	DVR-2	V.AUX
Default setting	<b>HDMI4</b>	<b>HDMI5</b>	<b>HDMI6</b>	None



- With an HDMI connection, video and audio signals are transmitted simultaneously. To play the video signal assigned at "HDMI" combined with the audio signal assigned at "Digital", select "Digital" at the GUI menu "Source Select" – "Input Mode" (page 45).
- When the AVP-A1HD and monitor are connected with an HDMI cable, if the monitor is not compatible with HDMI audio signal playback, only the video signals are output to the monitor.
- The audio signals input from the analog, digital and EXT. IN connectors are not output to the monitor.

### NOTE

This cannot be set for input sources for which "iPod dock" is assigned.

\* : "Play" and "Playback Mode (iPod)" are displayed for input sources for which "iPod dock" is assigned.

### Digital

Select digital input connector to assign to this source.

[Input source]

DVD HDP TV/CBL SAT VCR DVR-1 DVR-2 V.AUX  
TUNER CD

[Selectable items]

Coaxial1 ~ 4 Optical1 ~ 5 DENON LINK \* BNC1/2 None

\*: When a DENON DVD player and the DENON LINK have been connected, be sure to make a setting to "DENON LINK".

Input source	DVD	HDP	TV/CBL	SAT	VCR
Default setting	Coaxial 1	Coaxial 2	Optical 1	Coaxial 3	Optical 4

Input source	DVR-1	DVR-2	V.AUX	TUNER	CD
Default setting	Optical 2	Optical 3	Optical 5	None	Coaxial 4

**NOTE**

This cannot be set for input sources for which "iPod dock" is assigned.

### Component

Select component video input to assign to this source.

[Input source]

DVD HDP TV/CBL SAT VCR DVR-1 DVR-2 V.AUX

[Selectable items] 1 ~ 5 - RCA 6 - BNC None

Input source	DVD	HDP	TV/CBL	SAT
Default setting	1-RCA	2-RCA	3-RCA	4-RCA

Input source	VCR	DVR-1	DVR-2	V.AUX
Default setting	None	5-RCA	None	None

**NOTE**

This cannot be set for input sources for which "iPod dock" is assigned.

### Analog

Select the analog connector using the CD input.

[Input source]

CD

[Selectable items]

RCA

XLR



- ① GROUND
- ② HOT
- ③ COLD

XLR (INV)



- ① GROUND
- ② COLD
- ③ HOT

**NOTE**

When you assign "iPod dock," you cannot select "XLR," or "XLR(INV)".

### iPod dock

Assign Control Dock for iPod to this source.

[Input source]

DVD HDP TV/CBL SAT VCR DVR-1 DVR-2 V.AUX  
TUNER CD

[Selectable items] Assign None



- With the default settings, the Control Dock for iPod can be used connected to the VCR (iPod) connector.
- Even if "iPod dock" is set to "Assign," if the set is not connected to a Control dock for iPod, the input source can be used as the normal input source.

**4 Video**  
Setting the video source.

### Video Select

Switch video input source while listening to audio signal.

[Selectable items]

DVD HDP TV/CBL SAT VCR DVR-1 DVR-2 V.AUX  
SOURCE



### Operating from the main unit

Press the **VIDEO SELECT** button, then turn the **SOURCE SELECT** knob until the desired picture appears.

※ To cancel, press the main unit's **VIDEO SELECT** button, then turn the main unit's **SOURCE SELECT** knob and select "SOURCE".

**NOTE**

- It is not possible to select HDMI input signals.
- When playing HDMI video input signals, the analog video signal of another input source cannot be selected for the HDMI video output.
- Input sources for which "Delete" is selected at "Source Delete" cannot be selected.

### Video Convert

Automatically convert video input signal to monitor output format.

[Input source]

DVD HDP TV/CBL SAT VCR DVR-1 DVR-2 V.AUX

[Selectable items] ON OFF

**NOTE**

- For optimum video performance, THX recommends that you set the conversion mode to "OFF" to use video signals pass through system without up conversion.
- Example:** View video input from a component video on the component video monitor.
- When a non-standard video signal from a game machine or some other source is input, the video conversion function might not operate. If this happens, please set the conversion mode to "OFF".

### i/p Scaler

Make settings for i/p scaler function.

[Selectable items] A to H A to H & H to H OFF



- This can not be set when "Video Convert" is set to "OFF".
- The "A to H & H to H" can be set to the input source assigned to the HDMI input connector.
- "A to H & H to H" setting:
  - Deep color (10 bit/12 bit) signals are converted into 8-bit signals.
  - The i/p scaler function does not work if xVCC or computer's resolution signals are input.



## Resolution

Set resolution for video signal output to HDMI.

[Selectable items] **Auto** 480p/576p 1080i 720p 1080p

### Operating from the main unit

Press the **SCALE** button.

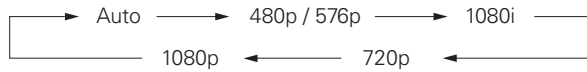

- This can be set when “i/p Scaler” is set to anything other than “OFF”.
- When the “i/p Scaler” is set to “A to H & H to H,” the resolutions can be setup to the analog video input signal and HDMI input signal.

## Progressive Mode

Select optimum progressive mode for video material.

[Selectable items] **Auto** Video1 Video2



This can be set when “i/p Scaler” is set to anything other than “OFF”.

## Aspect

This sets the aspect ratio when outputting 480i/576i or 480p/576p input signals from the HDMI output connector.

[Selectable items] **Full** Normal



This can be set when “i/p Scaler” is set to anything other than “OFF”.

## 5 Input Mode

Make input mode and decode mode settings for this source. The selectable input modes depend on the input source and “Assign” setting ( page 43, 44).

### Input Mode

Set the input mode for this source.

[Input source] **PHONO** ( iPod )

[Selectable items] **Analog** EXT. IN

[Input source] **NET/USB**

[Selectable items] **Auto** EXT. IN

[Input source]

**DVD** **HDP** **TV/CBL** **SAT** **VCR** **DVR-1** **DVR-2** **V.AUX**

**TUNER** **CD**

[Selectable items]

**Auto** **HDMI** **Digital** **Analog** **EXT. IN**



When a digital signal is properly input, the “DIG.” indicator lights on the display. If the “DIG.” indicator does not light, check the digital input connector assignment and the connections.

### Operating from the main unit or main remote control unit

Press the **INPUT MODE** button on the main unit or the **INPUT** button on the main remote control unit.

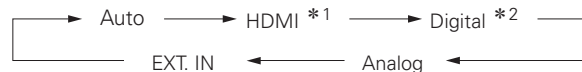

\*1: This can be selected for input sources for which the GUI menu “Assign” setting is set to “HDMI” ( page 43). Excluding CD and TUNER.

\*2: This can be selected for input sources for which the GUI menu “Assign” setting is set to “Digital” ( page 44).

## Decode Mode

Set the decode mode for this source.

[Input source]

**DVD** **HDP** **TV/CBL** **SAT** **VCR** **DVR-1** **DVR-2** **V.AUX**

**TUNER** **CD**

[Selectable items] **Auto** **PCM** **DTS**



- This can be selected for input sources for which the GUI menu “Assign” setting is set to “HDMI” or “Digital”.
- Only set “PCM” and “DTS” when playing the respective signals.

## 6 Rename

Change the display name for this source. Names containing up to 8 characters can be input.

[Characters that can be input]

**A ~ Z** **a ~ z** **0 ~ 9** **! " # % & ' ( ) \* + , - . / : ; < = > ? @ [ \ ] (space)**

## 7 Source Level

Corrects the playback level of the selected input source’s audio input.

[Variable range] **-12dB** ~ **0dB** ~ **+12dB**



For input sources for which “HDMI” or “Digital” are set at the GUI menu “Assign” setting, the analog input level and digital input level can be set separately.

## 8 Input Att.

Set when replay sound is distorted because the input level is too large.

[Selectable items] **OFF** **-6dB**

**9 Playback Mode**

Make settings for "NET/USB" playback.

[Input source] **NET/USB**

**USB Select**

Select USB port to use.

[Selectable items] **Front** **Rear**



Match the port to be used and the setting.

**Repeat**

Make settings for repeat mode.

[Selectable items] **All** **One** **OFF**

**Random**

Make random mode settings.

[Selectable items] **ON** **OFF**

**Direct Play**

Set the folder to be played using the **DIRECT PLAY** button on the sub remote control unit.

[Selectable items] **Favorites** **All Music**

**10 Still Picture**

Make settings for still picture (JPEG) playback.

[Input source] **NET/USB**

**Slide Show**

Make slideshow settings.

[Selectable items] **ON** **OFF**

**Interval**

Set the playback time per image.

[Variable range] **5s** ~ **60s**

**Surround Mode**

GUI

**HOME THX CINEMA**

THX surround mode to recreate authentic movie soundtracks.

**Surround Playback of 2-channel Sources**

[Selectable items]

**PLIIx CINEMA** **PLII CINEMA** **Pro Logic** **NEO:6 CINEMA**

**Playing Multi-channel Sources (Dolby Digital, DTS, etc.)**

[Selectable items]

**HOME THX CINEMA** :

This mode is for decoding the input signals according to their format and playing THX surround sound.

The display when the HOME THX CINEMA mode is selected depends on the input signal and surround back output playback mode.

Input signal		Display
Dolby Digital Source	DOLBY DIGITAL (other than 2ch) / DOLBY DIGITAL EX DOLBY DIGITAL Plus DOLBY TrueHD	THX SURROUND EX
		THX Ultra2 Cinema
DTS Surround Source	DTS (5.1ch) / DTS-ES Discrete 6.1 / DTS-ES Matrix 6.1 / DTS 96/24 / DTS-HD High Resolution Audio DTS-HD Master Audio	THX Music Mode
		THX Games Mode
		THX Cinema
		PLIIx C + THX
		ES MTRX6.1 + THX (* 1)
		ES DSCRT6.1 + THX (* 2)
DVD-Audio, SACD	PCM (multi ch) / DSD (multi ch)	THX Ultra2 Cinema
		THX Music Mode
		THX Games Mode
		THX Cinema
		PLIIx C + THX
		M CH 5.1 + THX
		M CH 7.1 + THX

\* 1: This is displayed when the input signal is "DTS-ES Matrix 6.1" and the AVP-A1HD's "AFDM" setting is set to "ON"

\* 2: This is displayed when the input signal is "DTS-ES Discrete 6.1"



For details, see page 84.

**Operating from the main unit or main remote control unit**

Press the **HOME THX CINEMA** button on the main unit or the **THX** button on the main remote control unit.

## Standard Playback

This is the standard mode for enjoying surround sound according to the program source.

To select these surround modes pressing the **STANDARD** button on the main unit or press the **STD** button on the main remote control unit. The mode switches each time the button is pressed.

## Surround Playback of 2-channel Sources

When using a surround back speaker

[Selectable items] **DOLBY PLIIx** **DTS NEO:6**

When not using a surround back speaker

[Selectable items] **DOLBY PLII** **DTS NEO:6**

**DOLBY PLIIx** or **DOLBY PLII** : The signals are decoded in DOLBY PLIIx or DOLBY PLII for playback.

**Cinema** : This mode is suited for movie sources.

**Music** : This mode is suited for music sources.

**Game** : This mode is suited for games.

**Pro Logic** : This is the Pro Logic playback mode. This can be selected when playing with a DOLBY PLII decoder. When this mode is selected, "DOLBY PL" is displayed.

### Operating from the main unit

The "Cinema," "Music," or "Game" modes can be directly selected with the **CINEMA**, **MUSIC** or **GAME** button on the main unit.



**DTS NEO:6** : The signals are decoded in DTS NEO:6 for playback.

**Cinema** : This mode is suited for movie sources.

**Music** : This mode is suited for music sources.

### Operating from the main unit

The "Cinema" or "Music" modes can be directly selected with the **CINEMA** button or **MUSIC** button on the main unit.

 Select the "Cinema," "Music," "Game" and "Pro Logic" modes at GUI menu "Parameter" - "Audio" - "Surround Parameters" - "Mode" ( page 48).

## Playing Multi-channel Sources (Dolby Digital, DTS, etc.)

[Selectable items]

**STANDARD** :

This mode is for decoding the input signals according to their format and playing surround sound.

The display when the STANDARD mode is selected depends on the input signal and surround back output playback mode.

Input signal		Display	
Dolby Digital Source	DOLBY DIGITAL (other than 2ch) / DOLBY DIGITAL EX	DOLBY DIGITAL DOLBY DIGITAL EX DOLBY DIGITAL+PLIIx CINEMA DOLBY DIGITAL+PLIIx MUSIC	
	DOLBY DIGITAL Plus	DOLBY DIGITAL +	
	DOLBY TrueHD	DOLBY TrueHD	
	DTS Surround Source	DTS (5.1ch) / DTS-ES Discrete 6.1 / DTS-ES Matrix 6.1 / DTS 96/24	DTS SURROUND DTS+PLIIx CINEMA DTS+PLIIx MUSIC DTS+NEO:6 DTS ES MTRX6.1 (* 1) DTS ES DSCRT6.1 (* 2) DTS 96/24 (* 3)
DTS-HD High Resolution Audio		DTS-HD HI RES	
DTS-HD Master Audio		DTS-HD MSTR	
DVD-Audio, SACD		PCM (multi ch) / DSD (multi ch)	MULTI CH IN MULTI IN+PLIIx CINEMA MULTI IN+PLIIx MUSIC MULTI CH IN 7.1

\* 1: This is displayed when the input signal is "DTS-ES Matrix 6.1" and the AVP-A1HD's "AFDM" setting is set to "ON".

\* 2: This is displayed when the input signal is "DTS-ES Discrete 6.1".



\* 3: This is displayed when the input signal is "DTS 96/24".

 For details, see page 84, 85.

## Dolby Headphone

The Dolby Headphone mode is set when headphones are connected to the **PHONES** jack while in the STANDARD (DOLBY/ DTS SURROUND) mode.

[Selectable items] **DOLBY HEADPHONE**

 When RECOUT mode is set to "SOURCE," with this amplifier signals encoded in the Dolby Headphone mode can be output from the recording output terminals and recorded on another recorder ( page 63).

## DSP Simulation Playback

The desired mode according to the program source and viewing situation can be selected from among 9 DENON original surround modes.

The surround parameters can be adjusted ( page 82, 83) to achieve an even more realistic, powerful sound field.

[Selectable items]

**7CH STEREO** \* 1 : This mode is for enjoying stereo sound from all speakers.

**WIDE SCREEN** : This mode is for enjoying the atmosphere of viewing a movie on a large screen.

**SUPER STADIUM** : This mode is suited for viewing sports programs.

**ROCK ARENA** : This mode is for enjoying the atmosphere of a live concert in an arena.

**JAZZ CLUB** : This mode is for enjoying the atmosphere of a live concert in a jazz club.

**CLASSIC CONCERT** : This mode is for appreciating classical concert programs.

**MONO** \* 2 : This mode is for playing monaural movie sources with surround sound.

**VIDEO GAME** : This mode is suited for achieving surround sound with video games.

**MATRIX** : This mode lets you add a sense of expansion to stereo music sources.

\* 1: Can also be set by pressing the **7CH STEREO** button on the main unit. However, the GUI menu is not displayed.

\* 2: When playing sources recorded in monaural in the MONO MOVIE mode, the sound will be off balance with a single channel (left or right), so input to both channels.



- Press the **DSP SIMULATION** button on the main unit or **SIMU** button on the main remote control unit to switch the surround mode. The mode switches each time the button is pressed.
- Depending on the program source being played, it may not be possible to achieve a satisfactory surround effect. In this case, try other modes to achieve a sound field suited to your tastes.

## Stereo Playback

### [Selectable items]

#### STEREO :

This is the mode for playing in stereo. The tone can be adjusted. Sound is output from the front left and right speakers and subwoofer.



When the main unit's **DIRECT/STEREO** button or the main remote control unit's **D/ST** button is pressed, DIRECT mode can be switched to STEREO mode.

## Direct Playback

### [Selectable items]

#### DIRECT :

In this mode the signals bypass the tone control circuitry for high quality sound.

The display when the DIRECT mode is selected depends on the input signal.

For multi-channel sources, the display depends on the surround back output's play mode.

Input signal	Display
Analog signal / PCM (2ch) / Dolby Digital source / DTS source / Other 2-channel digital signals	DIRECT
DSD (2ch)	DSD DIRECT (* )
PCM (multi ch)	MULTI CH DIRECT
	M DIRECT + PLIIx CINEMA
	M DIRECT + PLIIx MUSIC
	M DIRECT 7.1
DSD (multi ch)	DSD MULTI DIRECT (* )

\*: When DSD signals are converted to PCM signals as set by the audio parameters and speaker settings, "DIRECT" or "MULTI CH DIRECT" is displayed.



For details, see page 85.

## Playback in the PURE DIRECT Mode

This is the mode that recreates the original sound most faithfully, providing extremely high quality sound.

**Press the PURE DIRECT button on the main unit or the PURE button on the main remote control unit.**



- To cancel, press the **PURE DIRECT** button on the main unit or the **PURE** button on the main remote control unit.
- When in the PURE DIRECT mode, the GUI screen is not displayed and the display on the main unit is turned off.
- If the HDMI input connector is selected, video outputs are output in the PURE DIRECT mode.
- The channel level and surround parameters in the PURE DIRECT mode are the same as in the DIRECT mode.

## Parameter

Parameters can be called out directly by pressing the **PARA** button on the main remote control unit.

## Audio

Adjust various audio parameters.

### Menu tree

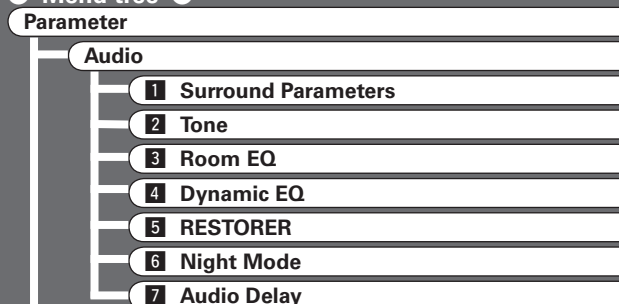

## 1 Surround Parameters

Adjust surround sound parameters.

The adjustable parameters differ for the different surround modes (📖 page 82, 83).

## Mode

Select the mode according to the playback source.

- In the PLIIx or PLII mode

[Selectable items] **Cinema** **Music** **Game** **Pro Logic**

- In the DTS NEO:6 mode

[Selectable items] **Cinema** **Music**



The "Music" mode is also effective for movie sources including a lot of stereo music.

- In the THX mode (for 2-channel sources)

**[Selectable items]**

**Surround Back ON** **Surround Back OFF** **THX Games Mode**

- In the THX mode (for Multi-channel sources)

**[Selectable items]**

**THX Surr. EX** **ES DSCRT** **ES MTRX** **7.1+THX**

**PLIIx Cinema + THX** **THX Ultra2 Cinema** **THX Music Mode**

**THX Games Mode** **Surround Back OFF**

## Decoder

Select this when playing analog, PCM or other 2 channel sources. The signals are converted into multichannel signals using the decoders shown below and played in the Dolby Headphone mode.

- In the THX mode (for 2-channel sources)

**[Selectable items]**

**PLIIx CINEMA** **PLII CINEMA** **Pro Logic** **NEO:6 CINEMA**

- In the DOLBY HEADPHONE mode

**[Selectable items]**

**PLII CINEMA** **PLII MUSIC** **NEO:6 CINEMA**

**NEO:6 MUSIC** **OFF**

## Cinema EQ

Soften the treble range of movie soundtracks for better understanding.

**[Selectable items]** **ON** **OFF**

## DRC

Compress dynamic range (difference between loud and soft sounds).

**[Selectable items]** **Auto** **Low** **Middle** **High** **OFF**



This can be set in the Dolby TrueHD mode.

## D.COMP

Compress dynamic range (difference between loud and soft sounds).

**[Selectable items]** **OFF** **Low** **Middle** **High**



When playing DTS sources, this is only displayed for compatible software.

## LFE

Adjust the low-frequency effects level (LFE).

**[Variable range]** **-10dB** ~ **0dB**



For proper playback of the different program sources, we recommend setting to the values below.

- Dolby Digital sources: "0 dB"
- DTS movie sources: "0 dB"
- DTS music sources: "-10 dB"

## Center Image

Assign center channel signal to front left and right channels for wider sound.

**[Variable range]** **0.0** ~ **0.3** ~ **1.0**

## Panorama

Assign front L/R signal also to surround channels, for wider sound.

**[Selectable items]** **ON** **OFF**

## Dimension

Shift sound image center to front or rear, to adjust playback balance.

**[Variable range]** **0** ~ **3** ~ **6**

## Center Width

Assign center channel signal to front left and right channels for wider sound.

**[Variable range]** **0** ~ **3** ~ **7**

## Delay Time

Adjust delay time to control sound stage size.

**[Variable range]** **0 ms** ~ **30 ms** ~ **300 ms**

## Effect

Switch effect signal for multi-surround speakers on and off.

**[Selectable items]** **ON** **OFF**

## Effect Level

Adjust effect signal level.

**[Variable range]** **1** ~ **10** ~ **15**

※ Only when the surround mode is "MONO"

**[Variable range]** **0** ~ **15**



Set to a lower level if the positioning and sense of phase of the surround signals seems unnatural.

## Room Size

Determine size of acoustic environment.

**[Selectable items]**

**Small** **Medium small** **Medium** **Medium large** **Large**

**NOTE**

"Room Size" does not indicate the size of the room in which sources are played.

## AFDM

Auto-select surround mode by source.

This function only works for software containing a special identification signal.

If the software being played is recorded in Dolby Digital EX or DTS-ES, it is played in 6.1-channels. If not, it is played in 5.1-channels.

[Selectable items] **ON** **OFF**

### Example : Playing Dolby Digital software (with EX flag)

- When "AFDM" is set to "ON", the surround mode is automatically set to the DOLBY D + PLIIx C mode.
- To play in the DOLBY DIGITAL EX mode, set "AFDM" to "OFF" and "SB CH Out" to "MTRX ON".



Some Dolby Digital EX sources do not include EX flags. If the playback mode does not switch automatically even when "AFDM" is set to "ON", set "SB CH Out" to "MTRX ON" or "PLIIx CINEMA".

## SB CH Out (for Multi-channel sources)

Select playback mode for surround back channels.

[Selectable items]

**NON MTRX** **MTRX ON** **PLIIx CINEMA** \*1 **PLIIx MUSIC** \*2  
**ES MTRX** \*3 **ES DSCRT** \*4 **DSCRT ON** **OFF**

\*1: This can be selected when "Surround Back" is set to "2spkr" at the GUI menu "Manual Setup" – "Speaker Setup" – "Speaker Configuration" setting (🔧 page 28).

\*2: This can be selected when "Surround Back" is set to "2spkr" or "1spkr" at the GUI menu "Manual Setup" – "Speaker Setup" – "Speaker Configuration" setting.

\*3: This can be selected when playing DTS sources.

\*4: This can be selected when playing DTS sources including a discrete 6.1-channel signal identification signal.

## SB CH Out (for 2-channel sources)

Determine whether to use surround back speakers.

[Selectable items] **ON** **OFF**

## Input Channel

Select channel using external input connectors (EXT.IN) for source being played.

[Selectable items] **8CH** **2CH**



Can be selected when GUI menu "Manual Setup" – "Audio Setup" – "EXT. IN Setup" – "Mode" is set to "DSP" (🔧 page 32).

## Subwoofer Att.

Attenuate subwoofer level when using EXT. IN input.

[Selectable items] **ON** **OFF**



Set this to "ON" if the subwoofer channel level seems too high when playing Super Audio CD.

## Subwoofer

Turn subwoofer output on and off.

[Selectable items] **ON** **OFF**

## Default

Resets the settings to the default values.

**2 Tone**  
Adjust the tonal quality of the sound.

## Tone Defeat

Turn tone adjustments off.

[Selectable items] **ON** **OFF**



The tone cannot be adjusted when in the DIRECT, PURE DIRECT and HOME THX CINEMA mode.

## Bass

Adjust bass for all channels together.

[Variable range] **-6dB ~ +6dB**

## Treble

Adjust treble for all channels together.

[Variable range] **-6dB ~ +6dB**



"Bass" and "Treble" can be set when "Tone Defeat" is set to "OFF".

## Front

Adjust each front channel tone.

[Selectable items] **Bass** **Treble**

[Variable range] **-6dB ~ +6dB**

## Center

Adjust each center channel tone.

[Selectable items] **Bass** **Treble**

[Variable range] **-6dB ~ +6dB**

## Surround

Adjust each surround channel tone.

[Selectable items] **Bass** **Treble**

[Variable range] **-6dB ~ +6dB**

## Surround Back

Adjust each surround back channel tone.

[Selectable items] **Bass** **Treble**

[Variable range] **-6dB ~ +6dB**

## Subwoofer

Adjust each subwoofer channel tone.

[Selectable items] **Bass**

[Variable range] **-6dB ~ +6dB**



This can be set individually for the separate surround mode other than PURE DIRECT, DIRECT and Home THX Cinema mode.

### 3 Room EQ

Select room equalizer for current environment.

[Selectable items]

**Audyssey** : Optimize frequency response of all speakers.

**Audyssey Byp. L/R** : Optimize frequency response of speakers except front L and R speakers.

**Audyssey Flat** : Optimize frequency response of all speakers to flat response.

**Manual** : Apply frequency response set with "Manual EQ" (page 33).

**OFF** : Turn equalizer off.



### Operating from the main unit or main remote control unit

Press the **ROOM EQ** button on the main unit or the **EQ** button on the main remote control.

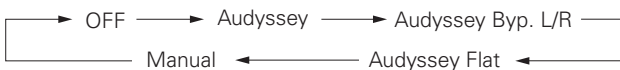

When "Audyssey" is selected, "AUDYSSEY MULTIEQ.XT" lights.

When "Audyssey Byp. L/R" or "Audyssey Flat" is selected, or when the auto setup measuring results have changed, "AUDYSSEY MULTIEQ.XT" lights.



- "Audyssey," "Audyssey Byp. L/R" and "Audyssey Flat" can be selected after the auto setup procedure has been performed.
- If the settings of the speakers for which "None" has been determined at "Auto Setup" are changed, "Audyssey," "Audyssey Byp. L/R" and "Audyssey Flat" cannot be selected and measurements have to be taken again to include the newly-added speakers.
- When using headphones, "Room EQ" is always set to "OFF".

### 4 Dynamic EQ

Make Dynamic EQ settings.

[Selectable items] **ON** **OFF**



### Operating from the main unit

Press the **DYNAMIC EQ** button.



- "Dynamic EQ" is displayed when selecting "Audyssey," "Audyssey Flat" or "Audyssey Byp.L/R" in the "Room EQ" setup. When set to "ON", the "AUDYSSEY DYNAMIC EQ" indicator is lit.
- When the audio setup measuring results have changed, "AUDYSSEY DYNAMIC EQ" lights.

### 5 RESTORER

This function restores compressed audio signals to how they were before compression and corrects the sense of volume of the bass and treble to obtain richer playback sound.

[Selectable items]

**OFF**

**Mode1** (RESTORER 64)

**Mode2** (RESTORER 96)

**Mode3** (RESTORER HQ)

The default setting for "NET/USB" and "iPod" is "Mode3". All others are set to "OFF".



### Operating from the main unit or main remote control unit

During playback, press the **RESTORER** button on the main unit or the **RSTR** button on the main remote control unit.

When set to something other than "OFF", "RESTORER" is displayed.

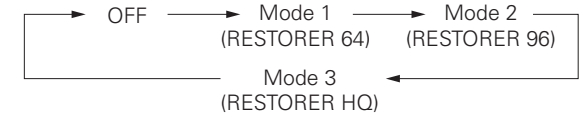

### About the RESTORER function

- Such compressed audio formats as MP3, WMA (Windows Media Audio) and MPEG-4 AAC reduce the amount of data by eliminating signal components that are hard for the human ear to hear. The RESTORER function generates the signals eliminated upon compression, restoring the sound to conditions near those of the original sound before compression. It also corrects the sense of volume of the bass to obtain richer sound with compressed audio signals.
- This is displayed on the GUI menu and can be set when the input source is set to "NET/USB", or when analog signals or PCM signals (fs = 44.1/48 kHz) are input.

### 6 Night Mode

Optimized setting for late-night listening.

[Selectable items] **OFF** **Low** **Middle** **High**



### Operating from the main unit or main remote control unit

Press the **NIGHT** button on the main unit or the **NGT** button on the main remote control unit.

The "NIGHT" indicator lights when "Low", "Middle" or "High" is selected.



## 7 Audio Delay

Compensate for mismatched timing between video and audio.

Delay audio.  
This sets the delay time for audio signals.

[Variable range]  ~

### Operating from the main unit or the main remote control unit



※ The GUI menu is not displayed when carrying out this setting.

- ① Press the **AUDIO DELAY** button on the main unit or **A. DL** button on the main remote control unit.
- ② Use the **◀▶** button to set.



- This cannot be adjusted when playing in the EXT. IN (when in analog mode), DIRECT or STEREO mode (with "Crossover Frequency" set to "FIXED-THX-"; "Front" set to "Large"; "Tone Defeat" to "ON" and "Room EQ" to "OFF").
- The adjustment range is 0 to 100 ms when the Auto Lipsync Correction function is activated.

## Picture Adjust

Adjust the picture quality.

● **Menu tree** ●

- Parameter
- Picture Adjust
  - 1 Contrast
  - 2 Brightness
  - 3 Chroma Level
  - 4 Hue
  - 5 DNR
  - 6 Enhancer
  - 7 Sharpness

## 1 Contrast

Adjust picture contrast.

[Variable range]  ~  ~

## 2 Brightness

Adjust picture brightness.

[Variable range]  ~

## 3 Chroma Level

Adjust picture chroma level (saturation).

[Variable range]  ~  ~

## 4 Hue

Adjust color hue.

[Variable range]  ~  ~

## 5 DNR

Reduces the overall level of noise on the picture.

[Selectable items]

## 6 Enhancer

Emphasize picture contours.

[Variable range]  ~

## 7 Sharpness

Adjust color definition.

[Variable range]  ~  ~



- When the input signal is 1080p the "Picture Adjust" setting will be ineffective.
- Adjusting the "Contrast," "Brightness," "Chroma Level" and "Hue" settings does not affect the HDMI input signal.
- "Hue" can be adjusted for composite video and S-Video signals.
- The adjustment values are stored for the individual input sources.
- "DNR," "Enhancer," and "Sharpness" are each effective with HDMI output. However, they are ineffective with 480i/576i output.

# Information



## Status

Shows information about current settings.

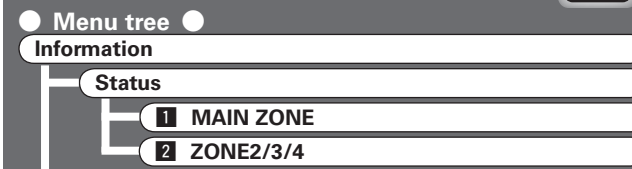

## 1 MAIN ZONE

Shows information about settings for MAIN ZONE.  
The items displayed differ according to the input source.

### [Items to be checked]

- 
- 
- 
- 
- 
- 
- 
- 
- 
- 
- 
- etc.

## 2 ZONE2/3/4

Shows information about settings for multi-zone.

### [Items to be checked]

- 
- 
-



## Audio Input Signal



Shows information about audio input signals.



### [Items to be checked]

- Surround Mode** : The currently set surround mode is displayed.
- Signal** : The input signal type is displayed.
- fs** : The input signal's sampling frequency is displayed.
- Format** : The number of channels in the input signal (front, surround, LFE) is displayed.
- Offset** : The dialogue normalization correction value is displayed.
- Flag** : "MATRIX" is displayed if the input signal has undergone matrix processing, "DISCRETE" if the input signal has undergone discrete processing.

### Dialogue normalization function

Dialogue Normalization (Dial Norm) is a feature of Dolby Digital, which is used to keep the programs at the same average listening level so the user does not have to change the volume control between Dolby Digital programs. When playing back software which has been encoded in Dolby Digital, sometimes you may see a brief message in the front panel display which will read "Dial. Norm X dB" (X being a numeric value). The display is showing how the program level relates with THX calibration level. If you want to play the program at calibrated theatrical levels, you may wish to adjust the volume. For example, if you see the following message: "Dial. Norm + 4 dB" in the front panel display, to keep the overall output level at THX calibrated loudness, just turn down the volume control by 4 dB. However, unlike a movie theater where the playback loudness is preset, you can choose your preferred volume setting for best enjoyment.

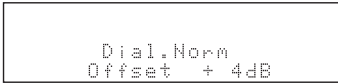

## HDMI Information



Shows information about HDMI input/output signals and monitor.

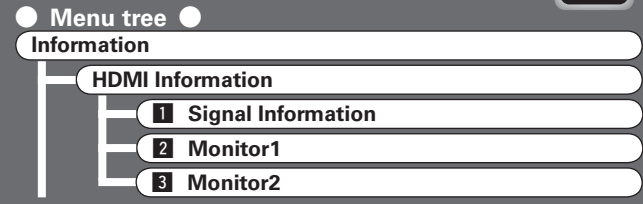

### 1 Signal Information

The HDMI input/output signal information is displayed.

- [Items to be checked] **Resolution** **Color Space** **Pixel Depth**

### 2 Monitor1

The HDMI monitor 1 information is displayed.

### 3 Monitor2

The HDMI monitor 2 information is displayed.

- [Items to be checked] **Interface** **Supported resol.**

## Auto Surround Mode



Shows information about auto surround mode settings.



The surround mode for which the last memory function was used for the different input signal types is displayed.

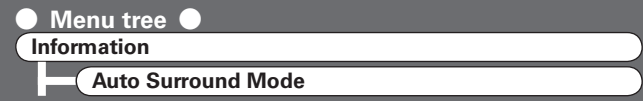

- [Items to be checked] **Analog/PCM 2ch** **Digital 2ch** **Digital 5.1ch** **Multi ch**

## Quick Select



Shows information about quick select settings.

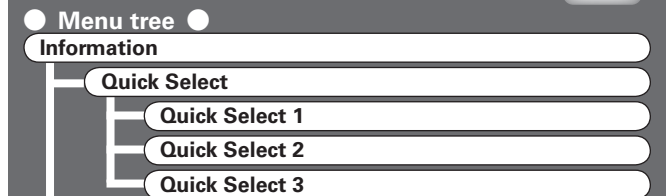

### [Items to be checked]

- Select Source** **Input Mode** **Room EQ**  
**Auto Surround Mode setting** **Volume Level**



For instructions on storing settings at Quick Select 1 to 3, see page 65.

## Preset Station



Shows information about preset stations.

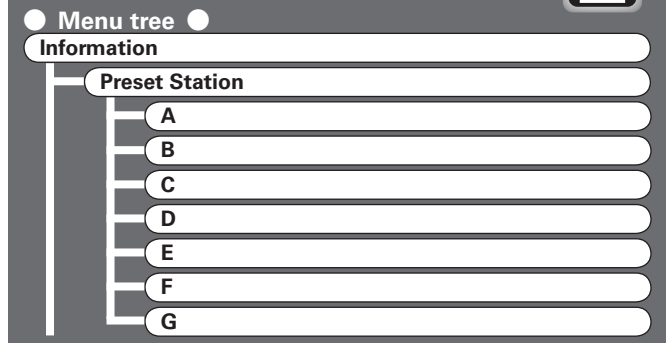

- [Input source] **NET/USB**

- [Items to be checked] **A1 ~ G8**



When the **STATUS** button on the main unit is pressed, the set's status can be checked on the display.

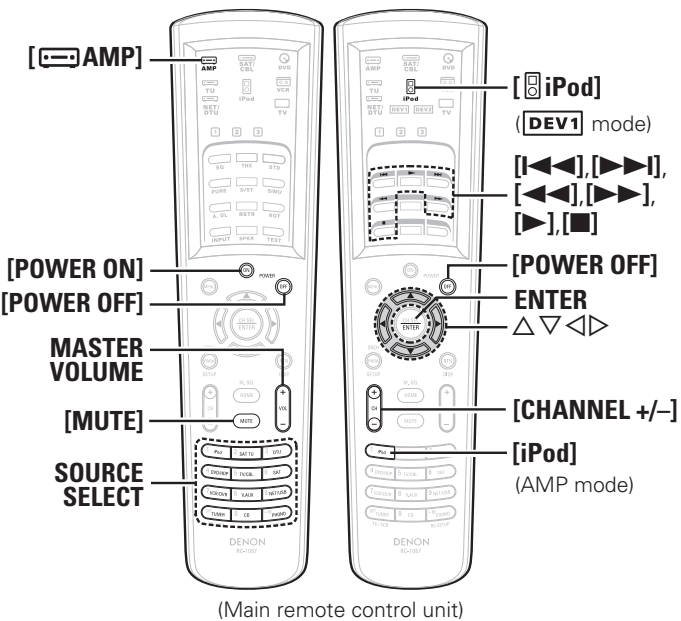
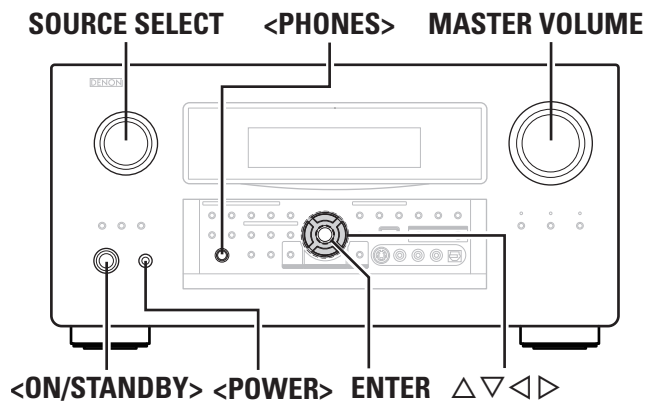

(Main remote control unit)

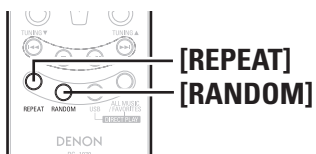

(Sub remote control unit)

**About the button names in these explanations**  
 < > : Buttons on the main unit  
 [ ] : Buttons on the remote control unit  
**Button name only:**  
 Buttons on the main unit and remote control unit

# Playback

## Preparations

### Turning the Power On

- 1 Press **<POWER>**.  
The power indicator lights red and the power is set to the standby mode.
- 2 Press **<ON/STANDBY>** or **[POWER ON]**.  
The power indicator flashes green and the power turns on.

**NOTE**  
 To operate the AVP-A1HD using the main remote control unit, set the remote control unit to the AMP mode (see page 66 "Remote Control Unit Operations").

### Turning the Power Off

- 1 Press **<ON/STANDBY>** or **[POWER OFF]**.  
The power is set to the standby mode.
- 2 Press **<POWER>**.  
The power indicator turns off, and so does the power.

**NOTE**  
 Power continues to be supplied to some of the circuitry even when the power is in the standby mode. When leaving home for long periods of time or when traveling, either press **<POWER>** to turn off the power, or unplug the power cord from the power outlet.

## Operations During Playback

### Adjusting the Master Volume

Either turn **<MASTER VOLUME>** or press **[MASTER VOLUME]**.

### Turning Off the Sound Temporarily (Muting)

Press **[MUTE]**.

**NOTE**  
 To cancel, press **[MUTE]** again. Muting can also be canceled by adjusting the master volume.

### Listening with Headphones

**Plug the headphones into <PHONES>**.  
 The sound from the pre-out connectors is automatically cut.

**NOTE**  
 Be careful not to set the volume too high when using headphones.

## Playing Video and Audio Equipment

### Basic Operation

- 1 Prepare the equipment.
  - 1 Load the DVD, CD or other software in the player.  
(See the operating instructions of the respective devices.)
  - 2 To play a video device, switch the monitor input.  
(See the monitor's operating instructions.)
- 2 To operate using the main remote control unit, set the remote control unit to the AMP mode.  
(page 66 "Remote Control Unit Operations")
- 3 Use **SOURCE SELECT** to select the input source.  
**GUI** : "Source Select" (page 42)
- 4 Start playback.  
(See the operating instructions of the respective devices.)

## iPod® Playback

The music on an iPod can be played by using the Control Dock for iPod (ASD-1R, sold separately). The operation can also be performed using the buttons on the main unit or remote control unit while watching the GUI menus.



iPod is a trademark of Apple Inc., registered in the U.S. and other countries.

※ The iPod may only be used to copy or play contents that are not copyrighted or contents for which copying or playback is legally permitted for your private use as an individual. Be sure to comply with applicable copyright legislation.

## Basic Operation

### 1 Make the necessary preparations.

- ① Set the iPod in the DENON Control Dock for iPod.  
(☞ See the Control Dock for iPod's operating instructions.)
- ② Assign the Control Dock for iPod's input.

**GUI** : "Source Select" – "(input source)" – "Assign" – "iPod dock" (☞ page 44)

### 2 Either turn <SOURCE SELECT> or press [iPod] (AMP mode) to select the input source assigned in step 1-② above.

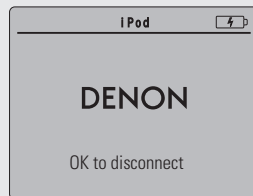

(iPod screen)

※ If the screens above are not displayed, the iPod may not be properly connected. Try connecting again.

**GUI** : "Source Select" – "(input source)" – "Play" (☞ page 43)

### 3 To operate using the main remote control unit, set the remote control unit to the iPod mode.

(☞ page 66 "Remote Control Unit Operations")



- With the default settings, the iPod can be used connected to the VCR (iPod) connector.
- Use the RESTORER mode to expand the low and high frequency components of compressed audio files and achieve a richer sound. The default setting is "Mode3".
- Press <ON/STANDBY> or [POWER OFF] and set the AVP-A1HD's power to the standby mode before disconnecting the iPod. Also switch the input source to one to which the GUI menu "iPod dock" is not assigned before disconnecting the iPod.

#### NOTE

- Depending on the type of iPod and the software version, some functions may not operate.
- DENON will accept no responsibility whatsoever for any loss of iPod data.

## Listening to Music

### 1 Use $\Delta$ $\nabla$ to select the menu, then press ENTER or $\triangleright$ to select the music file to be played.

### 2 Press ENTER or $\triangleright$ . Playback starts.

#### To pause

During playback, press ENTER or  $\triangleright$ .  
Press again to resume playback.

#### Fast-forwarding or fast-reversing

During playback, either press and hold  $\Delta$  (to fast-reverse) or  $\nabla$  (to fast-forward), or press [ $\ll$ ] or [ $\gg$ ].

#### To cue to the beginning of a track

During playback, either press  $\Delta$  (to cue to the previous track) or  $\nabla$  (to cue to the next track), or press [ $\ll$ ] or [ $\gg$ ].

#### To stop

During playback, either press and hold ENTER or press [■].

#### Playing repeatedly

Press [CHANNEL -] or [REPEAT] on the sub remote control unit.

[Selectable items] All One OFF

**GUI** : "Source Select" – "(input source)" – "Playback Mode (iPod)" – "Repeat" (☞ page 43)

#### Shuffling playback

Press [CHANNEL +] or [RANDOM] on the sub remote control unit.

[Selectable items] Albums Songs OFF

**GUI** : "Source Select" – "(input source)" – "Playback Mode (iPod)" – "Shuffle" (☞ page 43)

#### Searching up or down pages

Press [SEARCH], then press  $\triangleleft$  (down) or  $\triangleright$  (up).  
To cancel, press  $\Delta$   $\nabla$  or [SEARCH].

#### To switch between the Browse and Remote modes

Either press and hold [SEARCH].



- The title name, artist name and album name can be checked by pressing <STATUS> during playback.
- On the AVP-A1HD, folder and file names can be displayed as titles. Any characters that cannot be displayed are replaced with " . (period)".
- The time for which the GUI are displayed can be set at GUI menu "Manual Setup" – "Option Setup" – "GUI" – "iPod" (☞ page 39).

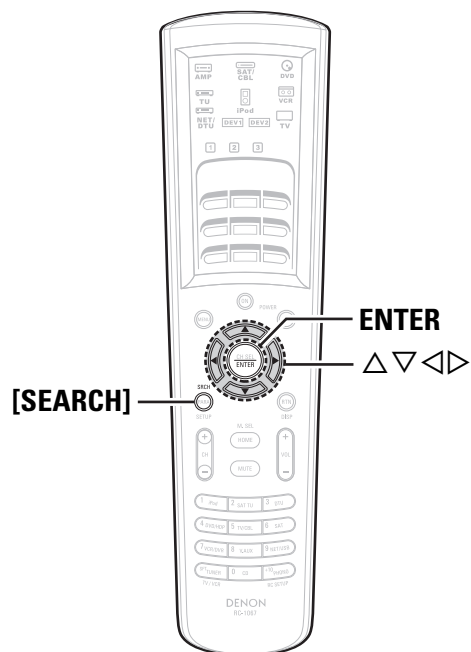
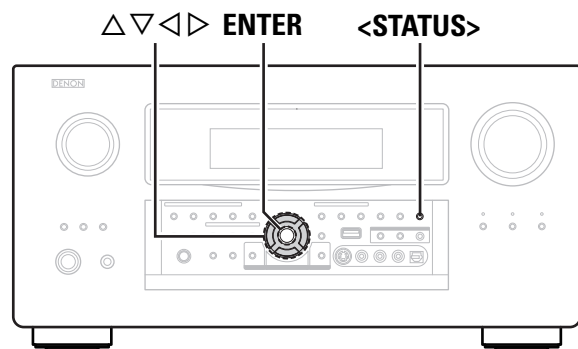

## Viewing Still Pictures or Videos on the iPod

Photo and video data on the iPod can be viewed on the monitor. (Only for iPod equipped with slideshow or video functions.)

- 1** Press and hold **[SEARCH]** to set the Remote mode. "Remote iPod" is displayed on the AVP-A1HD's display.
- 2** Watching the iPod's screen, use  $\Delta \nabla$  to select "Photos" or "Videos".
- 3** Press **ENTER** until the image you want to view is displayed.



"TV Out" at the iPod's "Slideshow Settings" or "Video Settings" must be set to "On" in order to display the iPod's photo data or videos on the monitor. For details, see the iPod's operating instructions.

## Playing Network Audio, USB Memory Devices

This procedure can be used to play Internet radio stations or music or still picture (JPEG) files stored on a computer or USB memory device.

### □ About the Internet radio function

- Internet radio refers to radio broadcasts distributed over the Internet. Internet radio stations from around the world can be tuned in. The AVP-A1HD is equipped with the following Internet radio functions:
  - Stations can be selected by genre and region.
  - Up to 56 Internet radio stations can be preset.
  - Internet radio stations in MP3 and WMA (Windows Media Audio) format can be listened to.
  - Your favorite radio stations can be registered by accessing an exclusive DENON Internet radio URL from a Web browser on a computer.
    - ※ The function is managed for individual users, so you must provide your MAC or e-mail address.
    - Exclusive URL: <http://www.radiodenon.com>
    - ※ The radio station database service may be suspended without notice.
- The AVP-A1HD's Internet radio station list is created using a radio station database service (vTuner). This database service provides a list edited and created for the AVP-A1HD.

### □ Media server

- This function lets you play music files and playlists (m3u, wpl) stored on a computer (media server) connected to the AVP-A1HD via a network. With the AVP-A1HD's network audio playback function, connection to the server is possible using one of the technologies below.
- Windows Media Player Network Sharing Service
  - Windows Media DRM10

### [Album art function]

When a WMA (Windows Media Audio), MP3 or MPEG-4 AAC file includes album art data, the album art can be displayed while the music files are playing.



For music files in WMA (Windows Media Audio) format, the album art is only played when using Windows Media Player ver. 11.

### About the button names in these explanations

- < > : Buttons on the main unit  
[ ] : Buttons on the remote control unit

#### Button name only:

Buttons on the main unit and remote control unit

**[Slide show function]**

Still picture (JPEG) files stored in folders on a media server can be played as slide shows.

The time for which each picture is displayed can be set.



When still picture (JPEG) files are played on the AVP-A1HD, they are played in the direction in which they are stored in the folder, so store in them in the direction in which you want them to play.

**Installing Windows Media Player ver. 11**

- ① If Windows XP Service Pack 2 has not yet been installed, either download it free of charge from Microsoft or install it via a Windows update installer.
  - ② Download the latest version of Windows Media Player ver. 11, either directly from Microsoft or using a Windows update installer.
- ※ When using Windows Vista, there is no need to download a new version of Windows Media Player.

**□ USB memory devices**

A USB memory device can be connected to the AVP-A1HD's USB port to play music and still picture (JPEG) files stored on the USB memory device.

- Only USB memory devices conforming to mass storage class and MTP (Media Transfer Protocol) standards can be played on the AVP-A1HD.
- The AVP-A1HD is compatible with USB memory devices in "FAT16" or "FAT32" format.

**[Album art function]**

When an MP3 music file includes album art data, the album art can be displayed while playing the file.

**[Slide show function]**

Still picture (JPEG) files stored on USB memory devices can be played as slide shows.

The time for which each picture is displayed can be set.



When still picture (JPEG) files are played on the AVP-A1HD, they are played in the direction in which they are stored in the folder, so store in them in the direction in which you want them to play.

**[Compatible formats]**

	Internet radio	Media server※	USB※
<b>WMA</b> (Windows Media Audio)	○	○	○*
<b>MP3</b> (MPEG-1 Audio Layer-3)	○	○	○
<b>WAV</b>	-	○	○
<b>MPEG-4 AAC</b>	-	○*	○*
<b>FLAC</b> (Free Lossless Audio Codec)	-	○	○
<b>JPEG</b>	-	○	○

A server or server software compatible with distribution in the corresponding formats is required to play music files via a network.

※: Only files that are not protected by copyright can be played on the AVP-A1HD.

Contents downloaded from pay sites on the Internet are copyright protected. Also, files encoded in WMA format when ripped from a CD, etc., on a computer may be copyright protected, depending on the computer's settings.

※ Media server and USB

- The AVP-A1HD is compatible with MP3 ID3-Tag (Ver. 2) standards.
- The AVP-A1HD is compatible with WMA META tags.

**[Playable formats]**

	Sampling frequency	Bit rate	Extension
<b>WMA</b> (Windows Media Audio)	32/44.1/48 kHz	48~192 kbps	.wma
<b>MP3</b> (MPEG-1 Audio Layer-3)	32/44.1/48 kHz	32~320 kbps	.mp3
<b>WAV</b>	32/44.1/48 kHz	-	.wav
<b>MPEG-4 AAC</b>	32/44.1/48 kHz	16~320 kbps	.aac/.m4a/.mp4
<b>FLAC</b> (Free Lossless Audio Codec)	32/44.1/48 kHz	-	.flac

WAV format Quantization bit rate: 16 bits.

<SOURCE SELECT> ENTER  $\Delta$   $\nabla$   $\triangleleft$   $\triangleright$  <STATUS>

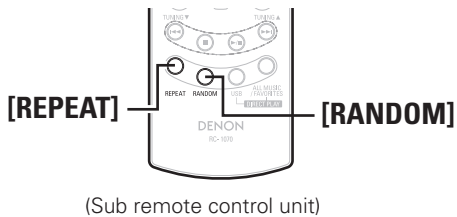
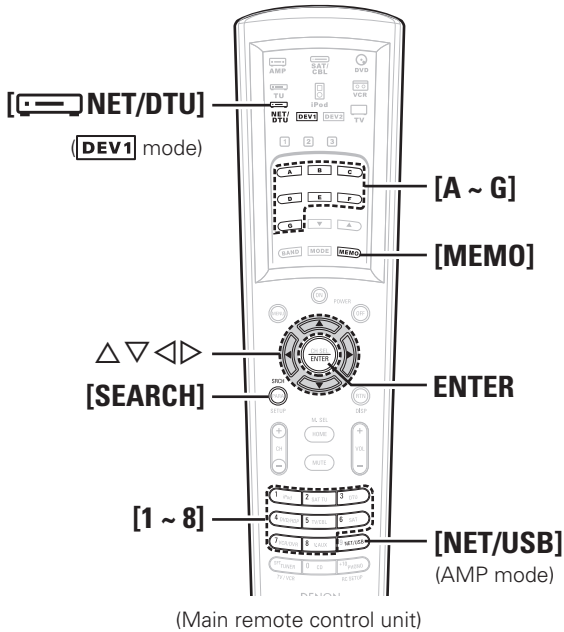
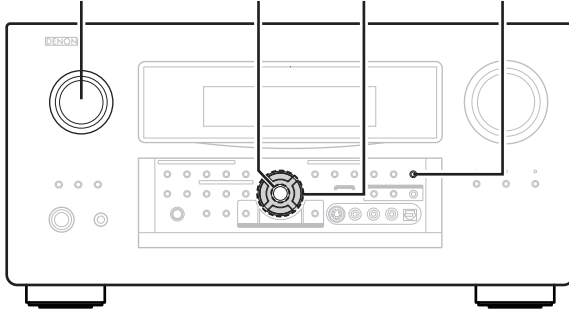

**About the button names in these explanations**  
 < > : Buttons on the main unit  
 [ ] : Buttons on the remote control unit  
**Button name only:**  
 Buttons on the main unit and remote control unit

**Basic Operation**

**1 Make the necessary preparations.**

- ① Check the network environment, then turn on the AVP-A1HD's power. (☞ page 20 "Network Audio")
- ② If settings are required, make the network settings. (☞ page 34 ~ 36 "Network Setup")
- ③ Prepare the computer. (☞ Computer's operating instructions) Install "Windows Media Player ver. 11".

**2 Either turn <SOURCE SELECT> or press [NET/USB] (AMP mode) to select "NET/USB".**

**GUI** : "Source Select" – "NET/USB" – "Play"  
 (☞ page 43)

**3 To operate using the main remote control unit, set the remote control unit to the NET/DTU ([DEV1]) mode.**

(☞ page 66 "Remote Control Unit Operations")

**4 Use  $\Delta$   $\nabla$  to select the menu, then press ENTER or  $\triangleright$  to select the file you want to play.**

**5 Press ENTER or  $\triangleright$ .**  
 Playback starts.

**Playing repeatedly**

Press [REPEAT] on the sub remote control unit.

[Selectable items] **All** **One** **OFF**

**GUI** : "Source Select" – "NET/USB" – "Playback Mode" – "Repeat" (☞ page 46)

**Playing in random order**

Press [RANDOM] on the sub remote control unit.

[Selectable items] **ON** **OFF**

**GUI** : "Source Select" – "NET/USB" – "Playback Mode" – "Random" (☞ page 46)



The repeat mode and random mode can only be used when playing tracks recorded in USB/Media Server.

**To pause**

During playback, press **ENTER**.  
 Press again to resume playback.

**To stop**

During the play or pause mode, press and hold **ENTER**.

**Searching up or down pages**

Press [SEARCH], then press  $\triangleleft$  (down) or  $\triangleright$  (up).  
 To cancel, press  $\Delta$   $\nabla$  or [SEARCH].

**Searching by first letter** (Character search)

This operation is convenient for choosing items from the menu screens for Internet radio stations or files stored on the computer.

- ① When the menu screen is displayed, press [SEARCH] twice.
- ② Use  $\triangleleft$   $\triangleright$  to select the first letter you want to search for.  
 If there are multiple items starting with the selected letter, they are displayed in alphabetical order.  
 If it is not possible to search the list, "unsorted list." is displayed.  
 To cancel, press or  $\Delta$   $\nabla$  or [SEARCH].



- Use the RESTORER mode to expand the low and high frequency components of compressed audio files and achieve a richer sound. The default setting is "Mode3".
- The time for which the GUI are displayed can be set at GUI menu "Manual Setup" – "Option Setup" – "GUI" – "NET/USB" (☞ page 39).
- Use <STATUS> to switch between displaying the title name, artist name or album name.

## Listening to Internet Radio

- 1** Use  $\Delta$ / $\nabla$  to select “Internet Radio”, then press **ENTER** or  $\triangleright$ .
- 2** Use  $\Delta$ / $\nabla$  to select the item you want to play, then press **ENTER** or  $\triangleright$ .  
The station list is displayed.
- 3** Use  $\Delta$ / $\nabla$  to select the station, then press **ENTER** or  $\triangleright$ .  
Playback starts once buffering reaches “100%”.



- There are many Internet radio stations on the Internet, and the quality of the programs they broadcast as well as the bit rate of the tracks varies widely.  
Generally, the higher the bit rate, the higher the sound quality, but depending on the communication lines and server traffic, the music or audio signals being streamed may be interrupted.  
Inversely, lower bit rates mean a lower sound quality but less tendency for the sound to be interrupted.
- “Server Full” or “Connection Down” is displayed if the station is busy or not broadcasting.
- On the AVP-A1HD, folder and file names can be displayed as titles.  
Any characters that cannot be displayed are replaced with “.” (period).

### ☐ Recently Played Internet Radio Stations

Recently played internet radio stations can be selected from “Recently Played” in top menu.

- 1** Use  $\Delta$ / $\nabla$  to select “Recently Played”, then press **ENTER** or  $\triangleright$ .
- 2** Use  $\Delta$ / $\nabla$  to select the item you want to play, then press **ENTER** or  $\triangleright$ .

#### NOTE

Up to 20 stations stored in “Recently Played”.

## Presetting Internet Radio Stations

Preset Internet radio stations can be selected directly.

- 1** While the Internet radio station you want to preset is playing, press [**MEMO**].
- 2** Use  $\Delta$ / $\nabla$  to select “Preset”, then press **ENTER**.
- 3** Press [**A ~ G**], then press [**1 ~ 8**] to select the desired preset number.  
The Internet radio station is now preset.

#### NOTE

If registered at a number that has already been preset, the previously registered setting is cleared.

### ☐ Listening to Preset Internet Radio Stations

Press [**A ~ G**], then press [**1 ~ 8**].

The AVP-A1HD automatically connects to the Internet and playback begins.

## Registering Internet Radio Stations as Your Favorites

Favorites are listed at the top of the menu screen, so when a station is registered as a favorite it can be tuned in easily.

- 1** Press [**MEMO**] while the Internet radio station you want to register is playing.
- 2** Use  $\Delta$ / $\nabla$  to select “Favorites”, then press **ENTER**.
- 3** Press  $\triangleleft$  to select “Yes”.  
The Internet radio station is registered.  
If you do not want to register it, press  $\triangleright$ .

### ☐ Listening to Internet Radio Stations Registered in Your Favorites

- 1** Use  $\Delta$ / $\nabla$  to select “Favorites”, then press **ENTER** or  $\triangleright$ .
- 2** Use  $\Delta$ / $\nabla$  to select the Internet radio station, then press **ENTER** or  $\triangleright$ .  
The AVP-A1HD automatically connects to the Internet and playback begins.

### ☐ Clearing Internet Radio Stations from Your Favorites

- 1** Use  $\Delta$ / $\nabla$  to select “Favorites”, then press **ENTER** or  $\triangleright$ .
- 2** Use  $\Delta$ / $\nabla$  to select the Internet radio station you want to clear, then press [**MEMO**].
- 3** Press  $\triangleleft$  to select “Delete”.  
The selected Internet radio station is cleared.  
To cancel the operation without clearing the station, press  $\triangleright$ .

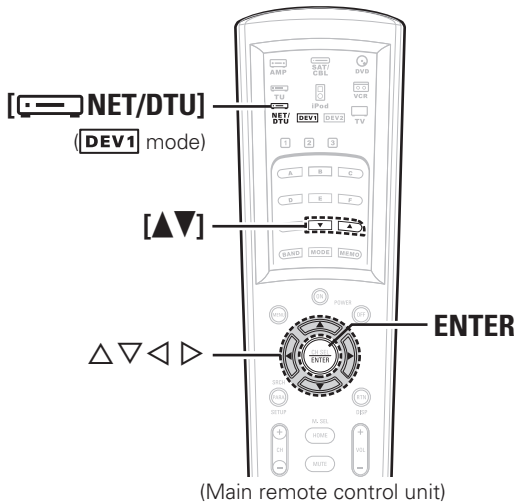
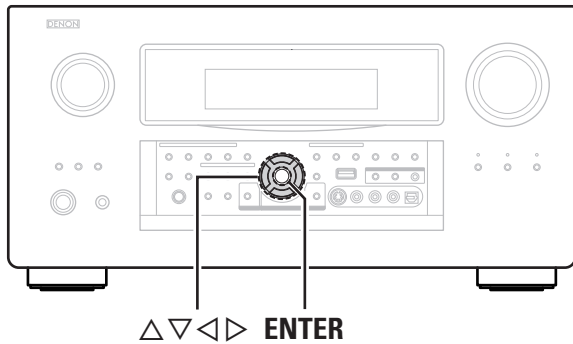

(Main remote control unit)

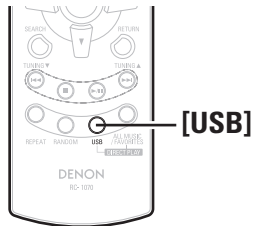

(Sub remote control unit)

**About the button names in these explanations**

< > : Buttons on the main unit  
 [ ] : Buttons on the remote control unit

**Button name only:**

Buttons on the main unit and remote control unit

**Playing Files Stored on a Computer**

Use this procedure to play music files, image files or playlists.

- 1** Use △▽ to select “Media Server”, then press ENTER or ▷.
- 2** Use △▽ to select the host name of the computer in which the music file you want to play is located, then press ENTER or ▷.
- 3** Use △▽ to select the search item or folder, then press ENTER or ▷.
- 4** Use △▽ to select the file, then press ENTER or ▷. Playback starts once buffering reaches “100%”.

**Selecting tracks**

During playback, either press △ (previous track) or ▽ (next track).



- When playing still picture (JPEG) files, files can also be selected using the operation described below. During playback, either press [▲] (previous file) or [▼] (next file).
- Connections to the required system and specific settings must be made in order to play music files (page 20).
- Before starting, you must launch the computer’s server software and set the files as server contents. For details, see the operating instructions of your server software.
- Depending on the size of the still picture (JPEG) file, some time may be required for the file to be displayed.

**Playing files that have been Preset or Registered in Your Favorites**

Files can be preset, registered in your favorites and played using the same operations as for Internet radio stations.

**NOTE**

- Presettings are erased by overwriting them.
- When the operation described below is performed, the media server’s database is updated and it may no longer be possible to play preset or favorite music files.
  - When you quit the media server and then restart it.
  - When music files are deleted or added on the media server.

**Playing Files Stored on USB Memory Devices**

Only USB memory devices conforming to mass storage class and MTP (Media Transfer Protocol) standards can be played on the AVP-A1HD.

**Basic Operation**

- 1** Make the necessary preparations.
  - Set the USB port to be used.

**GUI** : “Source Select” – “NET/USB” – “Playback Mode” – “USB Select” (page 46)

  - Connect the USB memory device to the set USB port.
- 2** Use △▽ to select “USB”, then press ENTER or ▷.
- 3** Use △▽ to select the search item or folder, then press ENTER or ▷.
- 4** Use △▽ to select the file, then press ENTER or ▷. Playback starts once buffering reaches “100%”.



- By default, the front panel’s USB port will be used.
- Depending on the size of the still picture (JPEG) file, some time may be required for the file to be displayed.

**Selecting tracks**

During playback, either press △ (previous track) or ▽ (next track).



- When playing still picture (JPEG) files, tracks can also be selected using the operation described below. During playback, either press [▲] (previous file) or [▼] (next file).
- If the USB memory device is divided into multiple partitions, only the top partition can be selected.
- The AVP-A1HD is compatible with MP3 files conforming to “MPEG-1 Audio Layer-3” standards.
- When [USB] is pressed, playback starts from the first track on the USB memory device.



**NOTE**

- The AVP-A1HD is equipped with two USB ports, one each on the front and rear panels. It is not possible to use the set with USB memory devices connected to both the ports at the same time. Select the USB port you want to use at the “Source Select” – “NET/USB” – “Playback Mode” – “USB Select” menu.
- DENON will accept no responsibility whatsoever for any loss or damage to data on USB memory devices when using the USB memory device connected to the AVP-A1HD.
- USB memory devices will not work via a USB hub.
- DENON does not guarantee that all USB memory devices will operate or receive power. When using a USB connection type portable hard disk of the type for which power can be supplied by connecting an AC adapter, we recommend using the AC adapter.
- It is not possible to connect and use a computer via the AVP-A1HD's USB port using a USB cable.
- The AVP-A1HD is not compatible with the iPod shuffle.

## Operating the AVP-A1HD Using a Browser (Web control)

This function lets you operate the AVP-A1HD using Internet Explorer.

### 1 Check the AVP-A1HD's IP address.

**GUI** : “Manual Setup” – “Network Setup” – “Network Information” (🔍 page 36)

### 2 Input the AVP-A1HD's IP address in Internet Explorer.

**Example** : “http://192.168.x.x/” (The “x” is digits.)

The AVP-A1HD can be operated in the same way as with regular Internet browsing.



To use the web control function, set the GUI menu “Manual Setup” – “Network Setup” – “Other” – “Power Saving” setting to “OFF” (🔍 page 36).

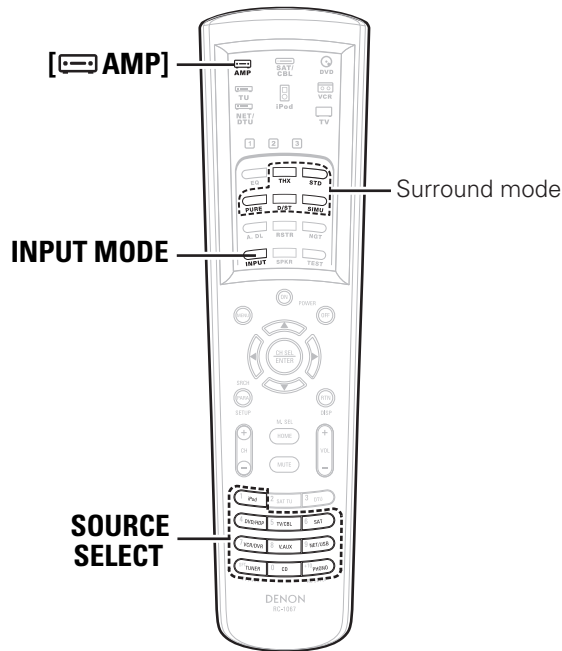
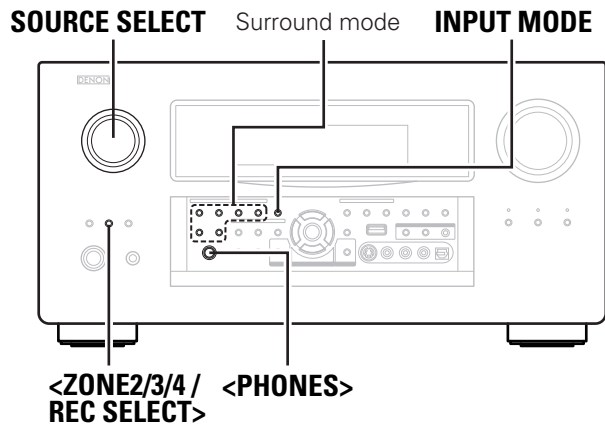

**About the button names in these explanations**  
 < > : Buttons on the main unit  
 [ ] : Buttons on the remote control unit  
**Button name only:**  
 Buttons on the main unit and remote control unit

# Other Operations and Functions

## Other Operations

### Playing Super Audio CD

- 1** Assign "DENON LINK" with the "Digital" setting or assign "HDMI" with the "HDMI" setting (☞ page 43, 44).
- 2** Either turn <SOURCE SELECT> or press [SOURCE SELECT] to select the input source assigned in step 1. The "D.LINK" or "HDMI" indicator lights on the display.
- 3** Select "AUTO" for the INPUT MODE (☞ page 45).
- 4** Select the surround mode (☞ page 46 ~ 48). We recommend playing in the DIRECT mode.
- 5** Start playing the Super Audio CD. The "DSD" indicator lights on the display. For operating instructions, refer to the respective equipment's operating instructions.

- When playing DSD signals in the DIRECT or PURE DIRECT mode, the DSD signals are converted as such into analog signals. When playing in other surround modes, the DSD signals are first converted into PCM format, then into analog signals.
- "DSD DIRECT" is shown on the display when playing DSD 2-channel signals in the DIRECT mode. "DSD MULTI DIRECT" is shown on the display when playing DSD multi-channel signals in the DIRECT mode.
- The DSD signal may not be output depending on the equipment that is connected. For further details, refer to the user manual for the equipment being used.

### Recording on an External Device (REC OUT mode)

You can listen to one program source while recording a different program source.

- 1** Press <ZONE2/3/4 / REC SELECT>. "ZONE3 SOURCE" is shown on the display.
- 2** Turn <SOURCE SELECT> until "RECOUT SOURCE" is displayed. The "REC" indicator lights.  

```

ZONE3 SOURCE ↔ ZONE3 TUNER ↔ ... ↔ ZONE3 NET/USB
    ↑                               ↓
    RECOUT NET/USB ← ... → RECOUT SOURCE
            
```
- 3** Turn <SOURCE SELECT> to choose the input source to be recorded.
- 4** Play the program source. For operating instructions, refer to the respective equipment's operating instructions.
- 5** Start recording. For operating instructions, refer to the respective equipment's operating instructions.

- To cancel, press <ZONE2/3/4 / REC SELECT>, then turn <SOURCE SELECT> until "ZONE3 SOURCE" is displayed.
- Make a test recording before starting the actual recording.
- Signals are only output to the analog REC OUT connectors when the digital signals input to the digital input connectors (OPTICAL/COAXIAL) are PCM (2-channel) signals.
- Digital audio signals input to the DENON LINK or HDMI connectors are not output to the REC OUT connectors, so connect using the OPTICAL or COAXIAL connectors.
- Sources selected with the REC OUT mode are output from ZONE3 as well.
- In the REC OUT mode, the remote control unit's ZONE3 mode buttons cannot be operated.
- When the "Digital Out" setting is set to "ZONE4 Select," the OPTICAL4 output connector becomes the ZONE4 output. When using for recording, set to "Rec Select"
- Copyright protected network audio (Internet radio, media server and USB) signals cannot be output from the digital output connectors (OPTICAL).

**NOTE**

- Recordings you make are for your personal enjoyment and should not be used for other purposes without permission of the copyright holder.
- When “DENON LINK” is assigned at the GUI menu “Assign” setting, the PCM signals, network audio signals (Internet radio, media server and USB), input from the digital input connectors cannot be output from the analog REC OUT connectors.
- Input sources for which “Delete” is selected at “Source Delete” cannot be selected.

**Dolby Headphone recording**

When REC OUT mode is set to “SOURCE”; with the AVP-A1HD it is possible to output signals encoded in the Dolby Headphone mode from the recording output terminal and record them on a separate recorder.

**1** The Dolby Headphone play mode is set when headphones are connected to <PHONES> during playback in the STANDARD (DOLBY/DTS Surround) mode.

When this is done, signals encoded in the Dolby Headphone mode are automatically output from the recording output terminals (analog and digital) and can be recorded.

**2** Select the parameters and set the desired mode.

Start recording.  
Refer to the “Dolby Headphone” (page 47).

**NOTE**

Do not disconnect the headphones during recording.

**Convenient Functions**

**HDMI Control Function**

When connecting the AVP-A1HD to a television or player compatible with the HDMI control function, the following operations are possible.

- Turn power ON/OFF (Synchronize with television)
- Switch to sound output equipment (TV and AVP-A1HD)
- Adjust volume
- Switch input source



- When using these functions set as follows: GUI menu “Manual Setup” – “HDMI Setup” – “HDMI Control” (page 31).
- When using these functions do not assign the “HDMI” to “TV/CBL”.

**Connections**

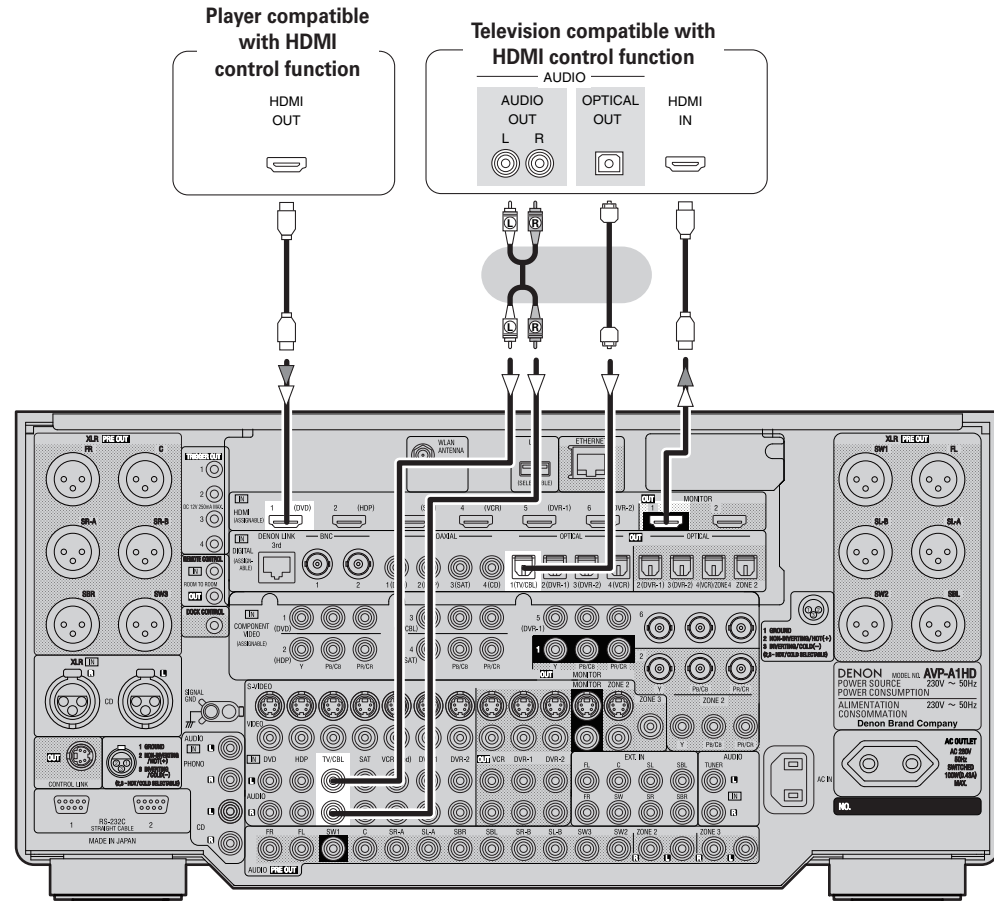

<STANDARD> <HOME THX CINEMA> QUICK SELECT

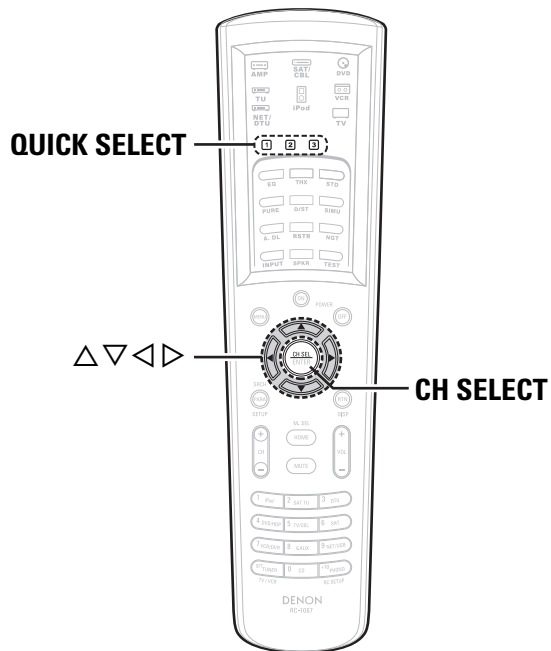
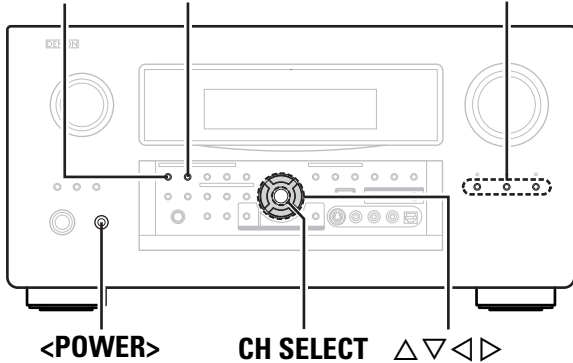

**About the button names in these explanations**  
 < > : Buttons on the main unit  
 [ ] : Buttons on the remote control unit  
**Button name only:**  
 Buttons on the main unit and remote control unit

**Operations**

**1** Connect the HDMI to the AVP-A1HD with equipment compatible with the HDMI control function.

**2** Put the power on for all the equipment connected to the HDMI.

**3** Check the settings for all the equipment connected to the HDMI and make HDMI available to them.

- ※ Please consult the operating instructions for the connected equipment to check the settings.
- ※ Operations 1~3 do not have to be repeated once started.
- ※ Carryout Operations 2 and 3 should any of the equipment be plugged out.

**4** Switch the television input to the HDMI connected to the AVP-A1HD.

**5** Switch the AVP-A1HD input to the HDMI input source and check if the picture from the player is ok.

**6** Put the television power on standby and check if the AVP-A1HD goes into standby.



- If the AVP-A1HD does not work please check the following.
- Is the GUI menu “Manual Setup” – “HDMI Setup” – “HDMI Control” – “Control” (page 31) set to “ON”?
  - Is the GUI menu “Manual Setup” – “HDMI Setup” – “HDMI Control” – “Control Monitor” (page 31) set for the monitor output connected to television?
  - Is the GUI menu “Manual Setup” – “HDMI Setup” – “HDMI Control” – “Power Off Control” (page 31) set to “ON”?
  - Is the control function used for the television HDMI properly set? (Check the television operating instructions for details.)
  - Should any of the operations below be performed, the interlocking function may be reset, in which case, repeat Operation's 2 and 3.
    - GUI menu “Source Select” – (input source) – “Assign” – “HDMI” (page 43) setting has changed
    - There is a change to the connection between the equipment and the HDMI, or an increase in equipment.
    - Change of HDMI monitor output in AVP-A1HD setup.

### Channel Level

You can adjust the channel level either according to the playback sources or to suit your taste, as described below.

**1** Press **CH SELECT**.

**2** Use  $\Delta$   $\nabla$  or **CH SELECT** to select the speaker.  
The speaker that can be set switches each time one of the buttons is pressed.

**3** Use  $\triangleleft$   $\triangleright$  to adjust the volume.  
※ "OFF" can be set by pressing  $\triangleleft$  when the subwoofer's volume is set to -12dB.

### Fader Function

This function lets you adjust (fade) the sound from all the front or rear speakers at once.

**1** Press **CH SELECT**.

**2** Press  $\Delta$   $\nabla$  or **CH SELECT** to select "Fader".

**3** Use  $\triangleleft$   $\triangleright$  to adjust the volume of the speakers.  
( $\triangleleft$ : front,  $\triangleright$ : rear)



- The fader function does not affect the subwoofer.
- The fader can be adjusted until the volume of the speaker adjusted to the lowest value is -12 dB.

### Quick Select Function

With this function, the currently playing input source, input mode, surround mode, room EQ settings and volume can be stored in the memory.

**1** Set the input source, input mode, surround mode, room EQ settings and volume to the conditions you want to store.

**2** Press and hold the desired **QUICK SELECT**.  
Keep pressing the button until the quick select indicator lights.

#### [Quick Select Defaults]

	Input Source	Volume
<b>Quick Select 1</b>	DVD	-40 dB
<b>Quick Select 2</b>	TV/CBL	-40 dB
<b>Quick Select 3</b>	VCR	-40 dB



- To call out the settings, press **QUICK SELECT** at which the desired settings were stored.
- The Quick Select name can be changed (☞ page 39).

#### NOTE

Input sources stored with the quick select function cannot be selected if they have been deleted at GUI menu "Manual Setup" - "Option Setup" - "Source Delete" (☞ page 39). In this case, store them again.

### Personal Memory Plus Function

This function sets the settings (input mode, surround mode, HDMI output mode, Picture Adjust, Audio Delay etc.) last selected for the individual input sources.

When you switch to an input source, the settings are automatically set to the ones that were set the last time that input source was used.



The surround parameters, tone control, room EQ settings and the volumes of the different speakers are stored for the individual surround modes.

### Last Function Memory

This stores the settings as they were directly before the standby mode was set.

When the power is turned back on, the settings are restored to as they were directly before the standby mode was set.

### Backup Memory

The various settings are backed up for about 1 week, even if the power is turned off or the power cord is disconnected.

### Resetting the Microprocessor

Perform this procedure if the display is abnormal or if operations cannot be performed.

All settings are reset when the microcomputer is reset.

**1** Turn off the power using **<POWER>**.

**2** Press **<POWER>** while simultaneously pressing **<STANDARD>** and **<HOME THX CINEMA>**.

**3** Once the display starts flashing at intervals of about 1 second, release the two buttons.



If in step 3 the display does not flash at intervals of about 1 second, start over from step 1.

# Remote Control Unit Operations

## Main Remote Control Unit

- On the main remote control unit, the display switches according to the device being operated and the mode.
- In modes other than iPod, the mode switches between "DEV1" and "DEV2" each time the [MODE SELECTOR] is pressed.
- In the AMP, NET/DTU (DEV1) and iPod modes, when the remote ID is set, the AVP-A1HD can be used independently even in an environment containing multiple DENON amplifiers.

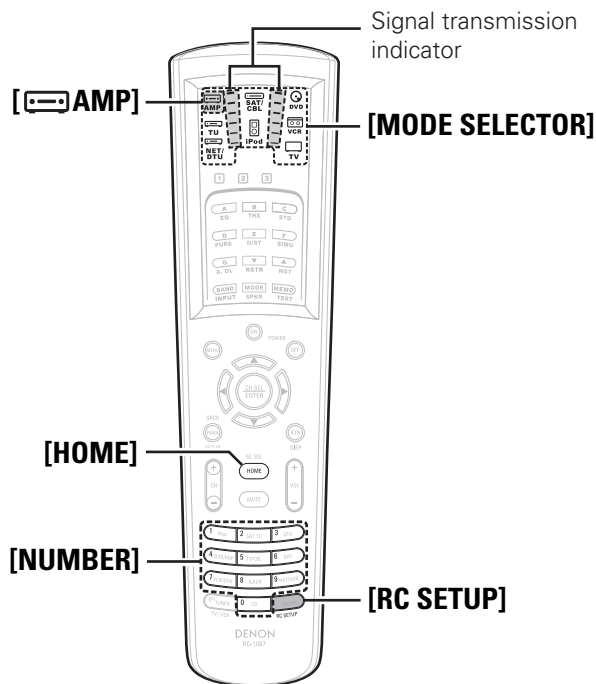

Depending on the model and year of manufacture of your equipment, some buttons may not operate.

**NOTE**

The device mode ("DEV1" or "DEV2") cannot be changed while the setting is being made.

## Operating DENON Audio Components

**1** Press [MODE SELECTOR] for the component to be operated.

The indicator for the component to be operated flashes.

- |   |  |
|---|--|
| : AMP / ZONE2 / ZONE3 / ZONE4 / SYSTEM CALL | : iPod   |
| : TUNER (FM/AM)                             | : DVD player (recorder) / CD player (recorder) |
| : NETWORK/USB / DIGITAL TUNER               | : VCR / TAPE                                   |
| : Satellite Receiver / Cable TV             | : TV   |

※ The mode switches each time [AMP] is pressed.

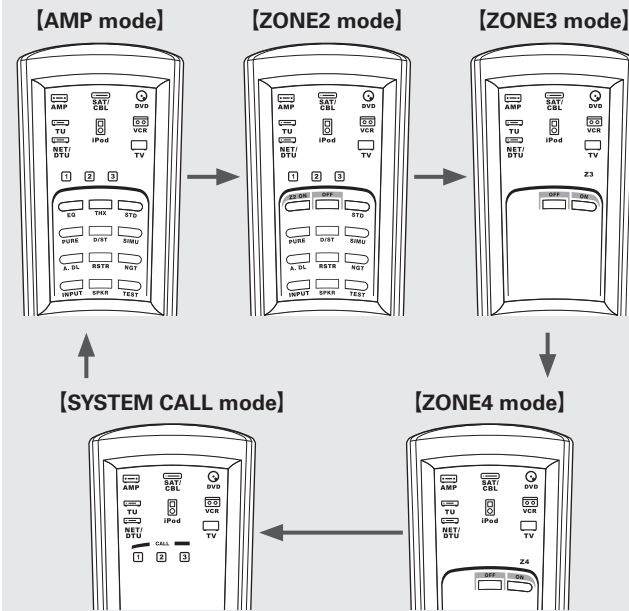

**2** Operate the component.

※ For details, refer to the component's operating instructions.

**[HOME]** is used to return to the AMP mode (AMP, ZONE2, ZONE3, ZONE4 or SYSTEM CALL) when in any mode other than AMP.

## Presetting

The included main remote control unit can be preset to operate devices of various brands.

**1** Press [MODE SELECTOR] for the device you want to preset.

**2** Press and hold in [RC SETUP] for at least 3 seconds. The signal transmission indicator flashes twice.

**3** Press [NUMBER] and input the 5-digit number of the brand of the component to be preset. The numbers are shown in the Preset Code Table (End of this manual).

When the code is registered, the signal transmission indicator flashes twice.

When the preset code is transmitted, the mode indicator for the component to which that code belongs flashes.

※ The input mode is canceled if no button is operated for 10 seconds.



Some brands have more than one preset code. If the component does not operate, try inputting a different code.

## Operating Preset Components

**1** Press [MODE SELECTOR] for the component to be operated.

The mode indicator of the device to be operated flashes.

**2** Operate the component.

※ For details, refer to the component's operating instructions.

Functions of Buttons by Component

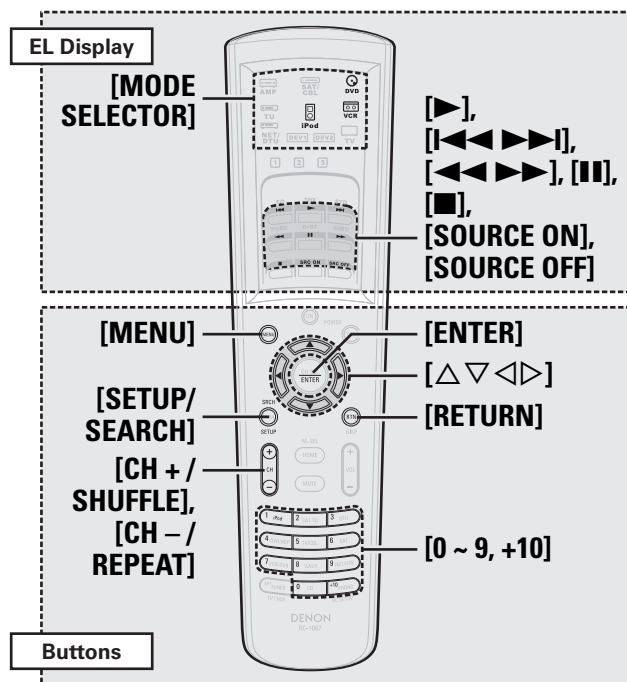

EL Display							
MODE SELECTOR	DVD				VCR		iPod
Device Mode	DEV1		DEV2		DEV1	DEV2	DEV1
Device operated	DVD (Default setting)	DVD Recorder	CD (Default setting)	CD Recorder	VCR	TAPE	iPod
▶	Playback	Playback	Playback	Playback	Playback	Playback	Playback/Pause
⏮ ⏪ ⏩ ⏭	Auto search (cue)	Auto search (cue)	Auto search (cue)	Auto search (cue)	Auto search (cue)	Auto search (cue)	Auto search (cue)
⏮ ⏪ ⏩ ⏭	Manual search (fast-reverse/fast-forward)	Manual search (fast-reverse/fast-forward)	Manual search (fast-reverse/fast-forward)	Manual search (fast-reverse/fast-forward)	Manual search (fast-reverse/fast-forward)	Manual search (fast-reverse/fast-forward)	Manual search (fast-reverse/fast-forward)
⏸	Pause	Pause	Pause	Pause	Pause	Pause	–
■	Stop	Stop	Stop	Stop	Stop	Stop	Stop
SOURCE ON	Power on	Power on	–	–	Power on	–	–
SOURCE OFF	Power off	Power off	–	–	Power off	–	–
Buttons							
MENU	Menu/guide	Menu/guide	–	–	Menu/guide	–	Menu
△ ▽ ◀ ▶	Cursor	Cursor	–	–	Cursor	–	Cursor
ENTER	Enter setting	Enter setting	–	–	Enter setting	–	Enter
SETUP/SEARCH	Set up	Set up	–	–	Set up	–	Page forward screen / Browse/Remote mode switching (Press and hold)
RETURN	Return	Return	–	–	Cancel	–	Return
CH + / SHUFFLE	–	–	–	–	Switch channels	–	1-track/album shuffle play
CH - / REPEAT	–	–	–	–	Switch channels	–	1-track/all-track repeat play
0 ~ 9, +10	Select track	Select track	Select track	Select track	–	–	–
Special Remarks	①, ②		①		①	①	–

**[Special Remarks]**

- ① Only one component can be preset for each mode. If a new code is preset, the previous code is automatically cleared.
- ② The names of the functions for the DVD remote control buttons differ from brand to brand. Check beforehand.

**NOTE**

- Preset a DVD player or DVD recorder for the “DVD” ([DEV1]) mode. Preset a CD player or CD recorder for the “DVD” ([DEV2]) mode.
- Preset a VCR for the “VCR” ([DEV1]) mode. Preset a tape deck for the “VCR” ([DEV2]) mode.





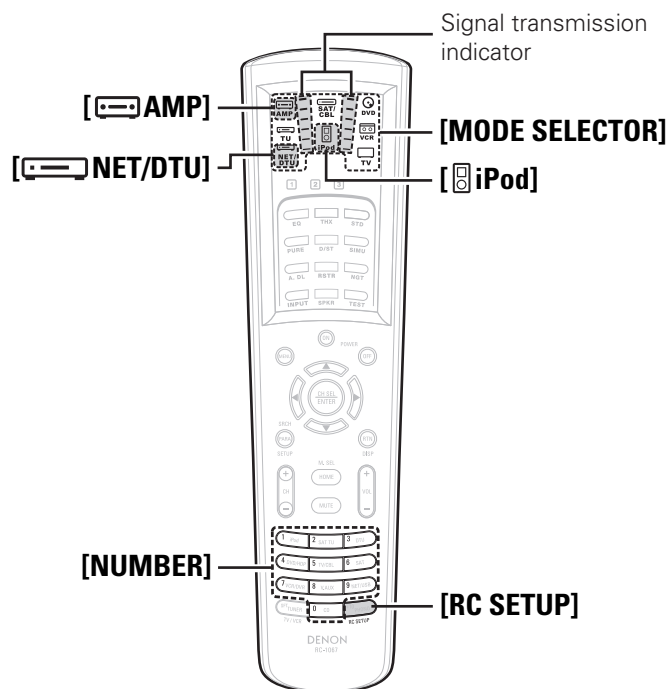

### Setting the Remote ID

When using multiple DENON AV receivers in the same room, make this setting so that only the desired AV receiver operates.

- 1** Press **[AMP]** to set the main remote control unit to the AMP mode.
- 2** Press and hold in **[RC SETUP]** for at least 3 seconds. The signal transmission indicator flashes twice.
- 3** Refer to the table at the right, and use **[NUMBER]** to input the 5-digit number corresponding to the remote ID to be changed. The signal transmission indicator flashes twice.
- 4** Press **[iPod]** or **[NET/DTU]** to select the mode to be set.
- 5** Repeat steps 2 to 4 to set the remote IDs for all modes.

MODE SELECTOR	AMP (MAIN)	iPod	NET/DTU
Remote ID			<b>[DEV1]</b> (Net Audio)
1 (Default)	81001	72815	62865
2	82001	72816	62837
3	83001	72817	62838
4	84001	72818	62839

#### NOTE

- When changing a setting, be sure to set the same remote ID as the AVP-A1HD's (page 40).
- When changing the AMP mode's remote ID, also change the "iPod" and "NET/DTU" remote ID at the same time.

### Learning Function

If your AV devices are of a brand other than DENON or if they cannot be operated with the preset memory function, their remote control signals can be transferred to stored in the AVP-A1HD's main remote control unit.

- 1** Press **[MODE SELECTOR]** for the device you want to set.
- 2** Press and hold in **[RC SETUP]** for at least 3 seconds. The signal transmission indicator flashes twice.
- 3** Press **[9], [7] and [5], in that order.** The signal transmission indicator flashes twice and the learning mode is set.
- 4** Press the button to be set. The main remote control unit's display turns off.
  - ※ If a button that cannot be learned is pressed, the signal transmission indicator lights but the signal is not learned.

- 5** Point the main remote control units directly at each other and press and hold the button on the other device's remote control unit that you want to learn.

Once learning is completed normally, the display lights and the signal transmission indicator flashes twice.

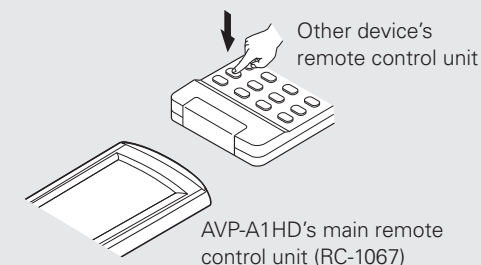

- ※ If you want to learn other buttons, repeat steps 4 and 5.
- ※ The mode can be switched by pressing **[MODE SELECTOR]**.
- ※ The signal transmission indicator lights once for a long time if learning was not possible.

- 6** Press and hold in **[RC SETUP]** for at least 3 seconds.

The signal transmission indicator flashes twice and the setting is completed.



- With some remote control units, the signals cannot be learned or the device will not operate properly even when the signals have been learned. In this case, use the device's own remote control unit.
- Learned buttons have priority over the preset memory. If you no longer need the learned setting, reset the learning function (page 71).

#### NOTE

- **[HOME]** cannot be learned.
- Do not learn any remote control signals at **[RC SETUP]**.
- The AMP, ZONE2, ZONE3, ZONE4 and SYSTEM CALL modes cannot be learned.

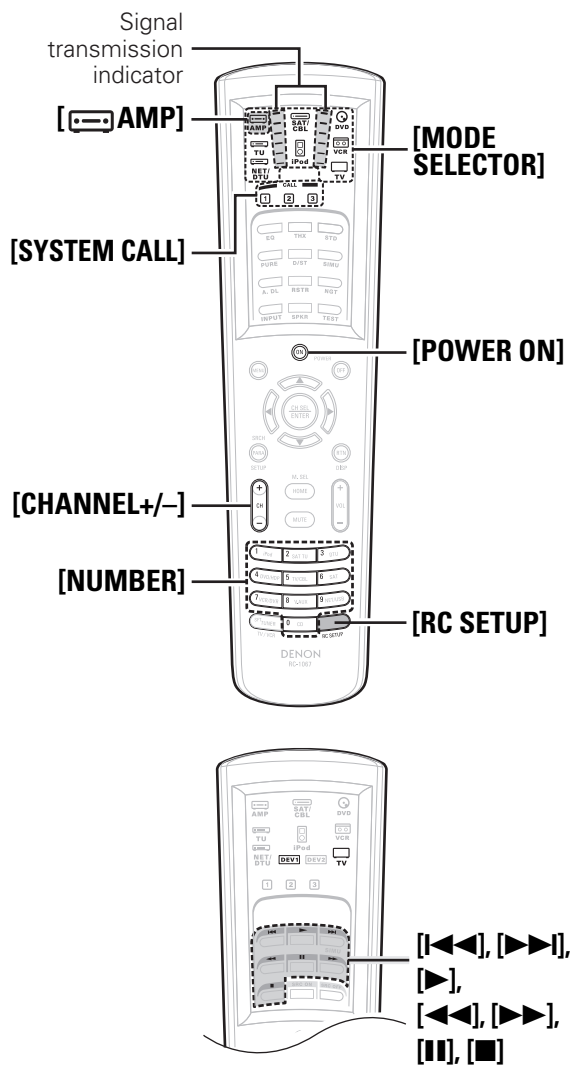

### System Call Function

This function lets you register a series of operations at a single button. For example, the amplifier can be turned on, the input source selected, the monitor's power turned on and the play mode set all by pressing a single button. Up to 32 signals each can be registered at [SYSTEM CALL] (1, 2 or 3).

- #### Registering
- 1 Press [MODE SELECTOR] for the device you want to register.
  - 2 Press and hold in [RC SETUP] for at least 3 seconds. The signal transmission indicator flashes twice.
  - 3 Press [9], [7] and [8], in that order. The signal transmission indicator flashes twice and the system call registration mode is set.
  - 4 Press [SYSTEM CALL] (1, 2 or 3) at which you want to register the signals.
  - 5 Press the buttons you want to register in the same sequence as the operations you want to perform. The signal transmission indicator lights when a button is pressed.  
**Example :** Press [POWER ON].  
 ↓  
 Press [MODE SELECTOR] – [DVD].  
 ↓  
 Press [▶].  
 ※ The mode can be switched by pressing [MODE SELECTOR].  
 ※ Perform the registration procedure for all the buttons you want to register.
  - 6 Press and hold in [RC SETUP] for at least 3 seconds. The signal transmission indicator flashes twice and the setting is completed.

- #### Calling out
- 1 Press [AMP], to select “SYSTEM CALL”.
  - 2 Press [SYSTEM CALL] (1, 2 or 3) at which the signals were registered. The registered signals are transmitted in the registered sequence.

- #### Punch Through Function
- CD, DVD or VCR mode buttons can be stored at unused TV or SAT/CBL mode buttons. For example, when DVD mode buttons are assigned to the TV mode, the DVD mode operations can be performed while in the TV mode.
- 1 Press [MODE SELECTOR] for the device you want to punch through (CD, DVD or VCR).
  - 2 Press and hold in [RC SETUP] for at least 3 seconds. The signal transmission indicator flashes twice.
  - 3 Press [9], [8] and [4], in that order. The signal transmission indicator flashes twice and the punch through setting mode is set.
  - 4 Press the button you want to punch through (▶, ■, ◀◀, ▶▶, ◀◀, ▶▶ or ||).
  - 5 Press [MODE SELECTOR] for the device you want to punch through (TV or SAT/CBL).
  - 6 Press and hold in [RC SETUP] for at least 3 seconds. The signal transmission indicator flashes twice and the setting is completed.

## Setting the Time the Backlight Stays Lit

- 1** Press and hold in **[RC SETUP]** for at least 3 seconds.  
The signal transmission indicator flashes twice.
- 2** Press **[9], [7]** and **[3]**, in that order.  
The signal transmission indicator flashes twice and the backlight on time setting mode is set.
- 3** Set the light on time.  
The signal transmission indicator flashes twice.  
[Settable times] : **[1]** : 5 sec.  
**[2]** : 10 sec. (Default)  
**[3]** : 15 sec.  
**[4]** : 20 sec.  
**[5]** : 25 sec.

## Adjusting the Backlight's Brightness

The display's brightness can be adjusted in 5 steps.  
(Default: Step 3)

- 1** Press and hold in **[RC SETUP]** for at least 3 seconds.  
The signal transmission indicator flashes twice.
- 2** Press **[CHANNEL +]** or **[CHANNEL -]**.  
The display gets one step brighter when **[+]** is pressed.  
The display gets one step darker when **[-]** is pressed.
- 3** Press **[RC SETUP]** to complete the setting.

## Resetting the Main Remote Control Unit

### Learning Function

#### [Resetting button by button]

- 1** Press **[MODE SELECTOR]** for the device you want to reset.
- 2** Press and hold in **[RC SETUP]** for at least 3 seconds.  
The signal transmission indicator flashes twice.
- 3** Press **[9], [7]** and **[6]**, in that order.  
The signal transmission indicator flashes twice.
- 4** Press the button you want to reset twice.  
The signal transmission indicator flashes twice.

#### [Resetting by device mode]

- 1** Press **[MODE SELECTOR]** for the device you want to reset.
- 2** Press and hold in **[RC SETUP]** for at least 3 seconds.  
The signal transmission indicator flashes twice.
- 3** Press **[9], [7]** and **[6]**, in that order.  
The signal transmission indicator flashes twice.
- 4** Press **[MODE SELECTOR]** for the device you want to reset twice.  
The signal transmission indicator flashes twice.

### System call function

- 1** Press and hold in **[RC SETUP]** for at least 3 seconds.  
The signal transmission indicator flashes twice.
- 2** Press **[9], [7]** and **[8]**, in that order.  
The signal transmission indicator flashes twice.
- 3** Press **[SYSTEM CALL]** (1, 2 or 3) you want to reset.
- 4** Press and hold in **[RC SETUP]** for at least 3 seconds.  
The signal transmission indicator flashes twice.

### Punch-through function

- 1** Press **[MODE SELECTOR]** for the device you want to reset (TV or SAT/CBL).
- 2** Press and hold in **[RC SETUP]** for at least 3 seconds.  
The signal transmission indicator flashes twice.
- 3** Press **[9], [8]** and **[4]**, in that order.  
The signal transmission indicator flashes twice.
- 4** Press and hold in **[RC SETUP]** for at least 3 seconds.  
The signal transmission indicator flashes twice.

### All settings

- 1** Press and hold in **[RC SETUP]** for at least 3 seconds.  
The signal transmission indicator flashes twice.
- 2** Press **[9], [8]** and **[1]**, in that order.  
The signal transmission indicator flashes 4 times.  
All the settings are restored to their defaults.

## Sub Remote Control Unit Operations

- The sub remote control unit is equipped with frequently used buttons, so it can be used for simple remote control unit operations.
- The sub remote control unit can also be used for multi-zone, so you can use it to control the AVP-A1HD from other rooms.
- The operations listed below can be performed with the sub remote control unit.
  - Switching the input source
  - Adjusting the volume
  - iPod operations
  - NET/USB direct play
  - GUI menu and ZONE2 on-screen display operations
  - Zone power on/off
- It is not possible to operate devices other than the amplifier.

## Functions of Buttons by Component

Device operated	DVD, HDP, TV / CBL, DVR-1, DVR-2, VCR, V.AUX, SAT, TUNER, CD, PHONO			
	M	Z2	Z3	Z4
<b>Zone selection</b>				
<b>ZONE SELECT</b>	Zone operation mode selection			
<b>ZONE OFF</b>	Power turned off (※1)			
<b>ZONE ON</b>	Power turned on (※1)			
<b>SOURCE SELECT</b>	Input source selection (※2)			
<b>VOLUME +/-</b>	Adjustment of volume (※1)			–
<b>MUTE</b>	Muting (※1)			–
<b>MENU</b>	Selected zone menu			–
<b>USB</b>	※3			–
<b>ALL MUSIC *</b> (Media server only)	※4			–
<b>FAVORITES *</b>	※5			–

- ※1: Affects the currently selected zone.
- ※2: In ZONE4, it is not possible to select sources with no digital input signals ("PHONO"; "iPod"; etc.).  
Network audio signals (Internet radio, media server, USB) can be played as long as they are not copyright-protected.
- ※3: The input source switches to "NET/USB" and the files on the USB memory device are played.
- ※4: The input source switches to "NET/USB" and the files in "All Music" on the media server are played.
- ※5: The input source switches to "NET/USB" and the files in "Favorites" are played.
- \*: Whether "All Music" or "Favorites" is selected depends on the "Direct Play" setting (page 46).

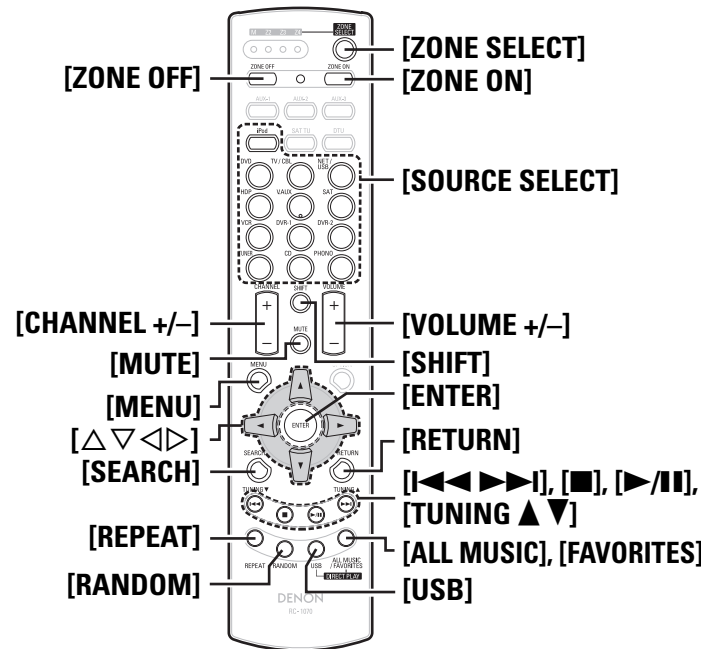

### DIRECT PLAY button

- Playback is possible in the mode selected at GUI menu "Source Select" – "NET/USB" – "Playback Mode" – "Direct Play".
- FAVORITES**: Playback starts from the first track registered in the favorites.
- ALL MUSIC**: Playback starts from the first track registered in the "All Music" folder.
- When **[USB]** is pressed, playback starts from the first track on the USB memory device.

#### NOTE

When the media server is stopped or restarted, it may no longer be possible to play tracks stored in the favorites.

Device operated	NET / USB				iPod			
	M	Z2	Z3	Z4	M	Z2	Z3	Z4
<b>ZONE SELECT</b>	Zone operation mode selection				Zone operation mode selection			
<b>ZONE OFF</b>	Power turned off (※1)				Power turned off (※1)			
<b>ZONE ON</b>	Power turned on (※1)				Power turned on (※1)			
<b>SOURCE SELECT</b>	Input source selection (※2)				Input source selection			–
<b>CHANNEL + / –</b>	Preset channel selection				–			
<b>VOLUME + / –</b>	Adjustment of volume (※1)			–	Adjustment of volume (※1)			–
<b>MUTE</b>	Muting (※1)			–	Muting (※1)			–
<b>MENU</b>	Selected zone menu			–	Selected zone menu			–
△ ▽ ◀ ▶	File operations			–	File operations			–
<b>ENTER</b>	File operations			–	File operations			–
<b>SEARCH</b>	Page forward screen / Character search			–	Page forward screen / Browse/Remote mode switching (press and hold)			–
<b>RETURN</b>	File operations			–	File operations			–
<b>I◀◀▶▶I, TUNING ▲ ▼</b>	Track search				Track search			–
■	Stop				Stop			–
<b>▶/II</b>	Play/pause				Play/pause			–
<b>REPEAT</b>	1-track/all-track repeat play (USB / Media server)				1-track/all-track repeat play			–
<b>RANDOM</b>	Random play (USB / Media server)				Song/album shuffle play			–
<b>USB</b>	※3				※3			–
<b>ALL MUSIC *</b> (Media server only)	※4				※4			–
<b>FAVORITES *</b>	※5				※5			–

※1: Affects the currently selected zone.

※2: In ZONE4, it is not possible to select or sources with no digital input signals (“PHONO”, “iPod”, etc.).

Network audio signals (Internet radio, media server, USB) can be played as long as they are not copyright-protected.

※3: The input source switches to “NET/USB” and the files on the USB memory device are played.

※4: The input source switches to “NET/USB” and the files in “All Music” on the media server are played.

※5: The input source switches to “NET/USB” and the files in “Favorites” are played.

\*: Whether “All Music” or “Favorites” is selected depends on the “Direct Play” setting (page 46).

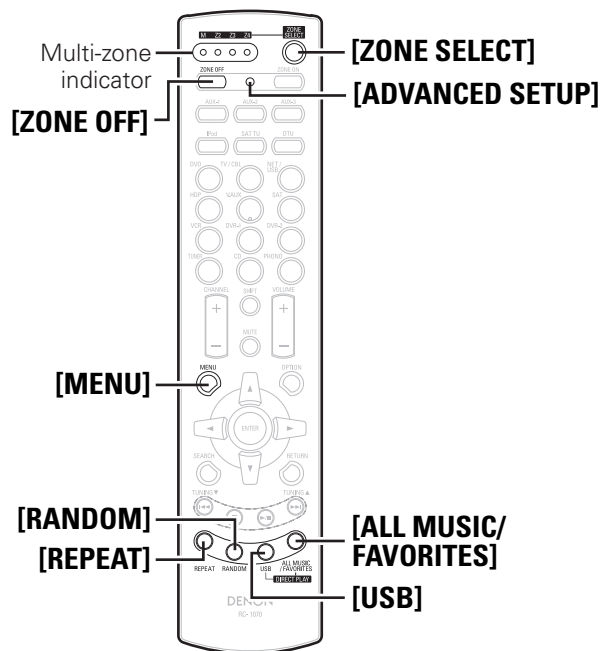

### Switching Zones

Use this procedure to select the zone to be operated by the sub remote control unit.

- 1** Press **[ZONE SELECT]**.  
The currently selected multi-zone indicator lights.
- 2** While the multi-zone indicator is light, press **[ZONE SELECT]** to select the zone to be operated.  
The currently selected multi-zone indicator lights.

### Setting the Zone for Which the Sub Remote Control Unit is Used (ZONE SELECT LOCK Mode)

We recommend always using the sub remote control unit for the same room. When this is done, the unit can be set so that the zone does not switch when buttons are operated.

- 1** Use the tip of a pen to press **[ADVANCED SETUP]**.  
All the multi-zone indicators light.
- 2** Select the multi-zone to be set.  
The selected multi-zone indicator lights.
  - ① To set to "MAIN ZONE" : Press **[REPEAT]**.
  - ② To set to "ZONE2" : Press **[RANDOM]**.
  - ③ To set to "ZONE3" : Press **[USB]**.
  - ④ To set to "ZONE4" : Press **[ALL MUSIC/FAVORITES]**.

- 3** Use the tip of a pen to press **[ADVANCED SETUP]**.  
The multi-zone indicator turns off.

#### To Cancel

- 1** Use the tip of a pen to press **[ADVANCED SETUP]**.  
The currently selected multi-zone indicator lights.
- 2** Press **[ZONE SELECT]**.  
All the multi-zone indicators light.
- 3** Use the tip of a pen to press **[ADVANCED SETUP]**.  
The multi-zone indicator turns off.

### Setting the Remote ID

When using multiple DENON AV receivers in the same room, make this setting so that no AV receiver other than the desired one operates.

- 1** While pressing **[MENU]**, press **[ADVANCED SETUP]** with the tip of a pen.  
The multi-zone indicator corresponding to the currently selected remote ID flashes.
- 2** Select the remote ID to be set.
  - ① To set to 1 : Press **[REPEAT]**.  
The "M" indicator flashes.
  - ② To set to 2 : Press **[RANDOM]**.  
The "Z2" indicator flashes.
  - ③ To set to 3 : Press **[USB]**.  
The "Z3" indicator flashes.
  - ④ To set to 4 : Press **[ALL MUSIC/FAVORITES]**.  
The "Z4" indicator flashes.

- 3** While pressing **[MENU]**, press **[ADVANCED SETUP]** with the tip of a pen.  
The multi-zone indicator turns off.

#### NOTE

When changing a setting, be sure to set the same remote ID as the AVP-A1HD's (page 40).

### Resetting the Settings

- While pressing **[ZONE OFF]**, press **[ADVANCED SETUP]** with the tip of a pen.  
All the multi-zone indicators flash 4 times, then all the settings are restored to their defaults.

# Multi-Zone Connections and Operations

## Multi-Zone Connections

- For ZONE2, it is necessary to set in sequence with the signal connected to either the power amplifier or bit stream amps. The amp should be the power amplifier in the case of ZONE3, and the bit-stream for ZONE4.
- If the signal inputted to ZONE2 is analog, change to PCM(2-channel) signal, and output it from ZONE2 optical output connectors.

	Connectors for audio output	Audio signals	Connectors for video output
ZONE2	ZONE2 PRE OUT	Stereo	ZONE2 VIDEO OUT, ZONE2 S-VIDEO OUT, ZONE2 COMPONENT VIDEO OUT
	ZONE2 OPTICAL OUT	Bit-stream	
ZONE3	ZONE3 PRE OUT	Stereo	ZONE3 VIDEO OUT
ZONE4	ZONE4 OPTICAL4 OUT	Bit-stream	-

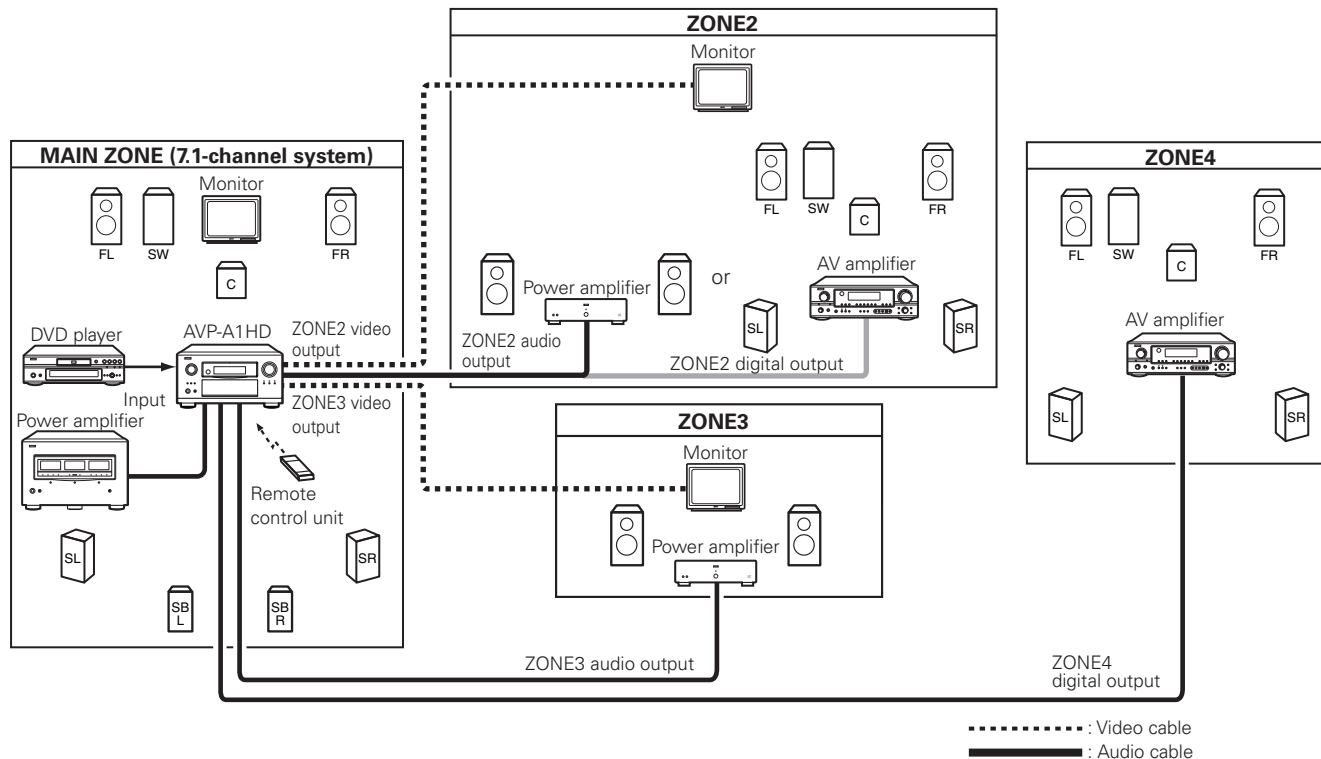

- When only using one speaker for ZONE2 or ZONE3, set to "Mono". In this case, the ZONE2 (ZONE3) monaural output is output from the ZONE2 (ZONE3) pre-out L and R connectors, so connect as desired.
- Separate power amplifiers are needed for ZONE2 and ZONE3.

**SOURCE SELECT <ZONE2/3/4 / REC SELECT> VOLUME**

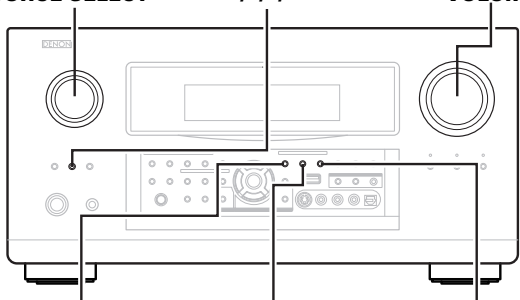

<ZONE2 ON/OFF> <ZONE3 ON/OFF> <ZONE4 ON/OFF>

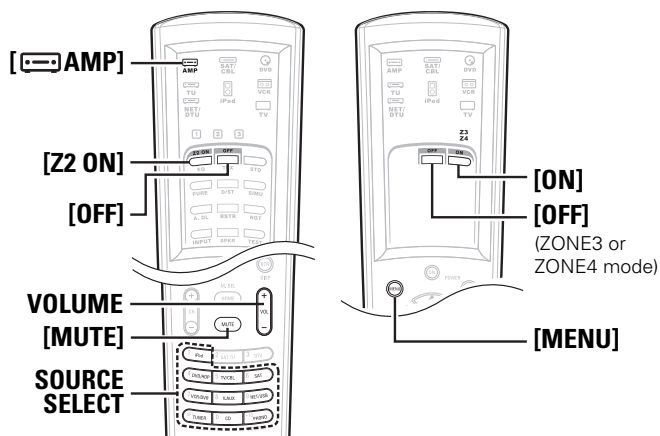

(Main remote control unit)

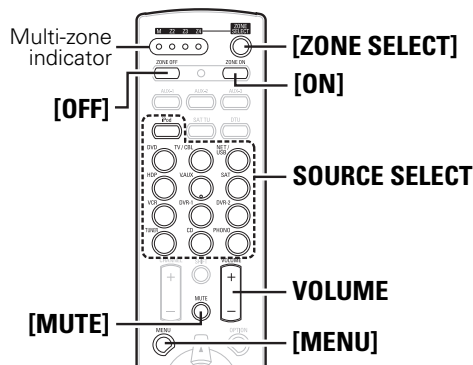

(Sub remote control unit)

**About the button names in these explanations**

- < > : Buttons on the main unit
- [ ] : Buttons on the remote control unit

**Button name only:**

Buttons on the main unit and remote control unit

**Multi-Zone Operations**

**Turning the Power On and Off**

**[Operation on the main unit]**

Press <ZONE2 ON/OFF>, <ZONE3 ON/OFF> or <ZONE4 ON/OFF> for the zone to be operated.

When the power turns on, the multi-zone indicator lights on the display.

**[Operation on the remote control unit]**

In the zone mode you want to operate, press [ON] or [OFF].

**Selecting the Input Source**

**[Operation on the main unit]**

- ① Press <ZONE2/3/4 / REC SELECT> and select the zone to be adjusted.
- ② Turn <SOURCE SELECT>.

**[Operation on the remote control unit]**

In the zone mode you want to operate, press [SOURCE SELECT].

**Adjusting the Volume**

**[Operation on the main unit]**

- ① Press <ZONE2/3/4 / REC SELECT> and select the zone to be adjusted.
- ② Turn <VOLUME> to adjust.

**[Operation on the remote control unit]**

In the zone mode whose volume you want to adjust, press [VOLUME].

[Variable range] --- -70dB ~ -40dB ~ 18dB



- The volume can be adjusted when GUI menu "Manual Setup" - "Zone Setup" - "(select the zone)" - "Volume Level" is set to "Variable". The volume can be increased up to the value set at GUI menu "Manual Setup" - "Zone Setup" - "(select the zone)" - "Volume Limit" (page 37).
- The volume for ZONE2 and ZONE3 can be adjusted with the remote control unit.

**Turning off the Sound Temporarily**

In the zone mode for which you want to mute the sound, press [MUTE].

The sound is reduced to the level set at GUI menu "Manual Setup" - "Zone Setup" - "(select the zone)" - "Mute Level" (page 37).

To cancel, either adjust the volume or press [MUTE] again.

The setting is canceled when the zone's power is turned off.



- The source selected for ZONE3 is also output from the recording output connectors.
- When the [MENU] is selected, it is possible to carryout "Zone Setup" looking at the on-screen display in ZONE2. Also, when the "OSD" is set as "ZONE2/ZONE3", the on-screen display comes on the ZONE2 monitor when ZONE3 has been operated so it is possible to operate it looking at this.

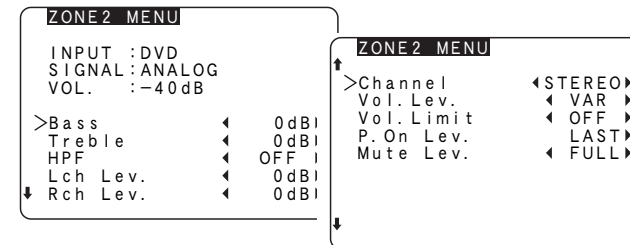

**NOTE**

- The digital signal from the digital input connectors (OPTICAL/COAXIAL) are output to the analog audio connectors in ZONE2 and ZONE3 in the case of PCM (2-channel) signals only.
- Digital audio signals input from the DENON LINK or HDMI connectors cannot be played in multi-zone.
- The digital output (OPTICAL) from ZONE2 and ZONE4 cannot be copyrighted network signals (internet radio, media server, and USB).
- When certain digital signals are being input, noise may be output from the ZONE2 and ZONE3 audio output connectors.



# Other Information

## About Speaker Installation

### Surround back speakers

The THX Surround EX format adds new "Surround Back" (SB) channels to the conventional 5.1 channel system. This makes it easy to achieve sound positioned directly behind the listener, something that was previously difficult with sources designed for conventional multi surround speakers. In addition, the acoustic image extending between the sides and the rear is narrowed, thus greatly improving the expression of the surround signals for sounds moving from the sides to the back and from the front to the point directly behind the listening position.

Change of positioning and acoustic image with 5.1-channel systems

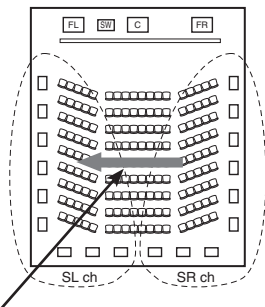

Movement of acoustic image from SR to SL

Change of positioning and acoustic image with 6.1-channel systems

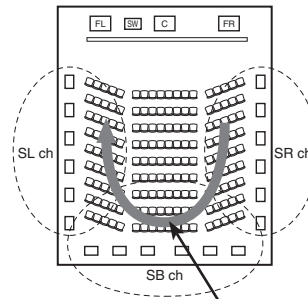

Movement of acoustic image from SR to SB to SL

In addition to sources recorded in 6.1-channels, the surround effect of conventional 2- to 5.1-channel sources can also be enhanced.

Speaker(s) for one or two channels are required in order to achieve a THX Surround EX system with the AVP-A1HD. Adding these, however, allows you to achieve stronger surround effects not only with sources recorded in THX Surround EX, but also with conventional 2- to 5.1 channel sources. The WIDE SCREEN mode is a mode for achieving surround sound with up to 7.1 channels using surround back speakers, for sources recorded in conventional Dolby Surround as well as Dolby Digital 5.1 channel and DTS Surround 5.1 channel sources. Furthermore, all the DENON original surround modes (page 47 "DSP Simulation Playback") are compatible with 7.1 channel playback, so you can enjoy 7.1 channel sound with any signal source.

### Number of surround back speakers

With THX Surround EX, the surround back channel consists of one channel of playback signals, but we recommend using two speakers. The modes that use the new ASA technology from THX (page 80) are most effective when using two monopole type surround back speakers placed close together.

Using two speakers results in a smoother blend with the sound of the surround channels and better sound positioning of the surround back channel when listening from a position other than the center.

### Placement of the surround left and right channels when using surround back speakers

Using surround back speakers greatly improves the positioning of the sound at the rear. Because of this, the surround left and right channels play an important role in achieving a smooth transition of the acoustic image from the front to the back. As shown on the diagram above, in a movie theater the surround signals are also produced from diagonally in front of the listeners, creating an acoustic image as if the sound were floating in space.

To achieve these effects, we recommend placing the speakers for the surround left and right channels slightly more towards the front than with conventional surround systems. Doing so sometimes increases the surround effect when playing conventional 5.1 channel sources in the THX Surround EX mode. Check the surround effects of the various modes before selecting the surround mode.

### Examples of speaker layouts

Below we introduce examples of speaker layouts. Refer to these to arrange your speakers according to their type and how you want to use them.

#### [1] For THX surround EX systems (Using surround back speakers)

##### ① When mainly playing movies

Recommended when your surround speakers are single or 2-way speakers.

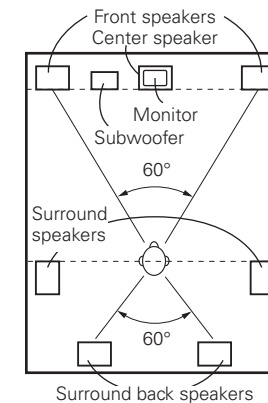

[As seen from above]

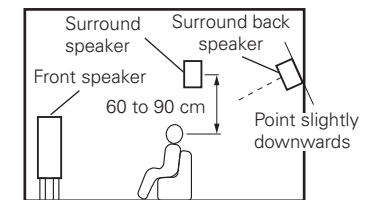

[As seen from the side]

② **Setting for primarily watching movies using diffusion type speakers for the surround speakers**

For the greatest sense of surround sound envelopment, diffuse radiation speakers such as bipolar (THX) types, or dipolar types, provide a wider dispersion than is possible to obtain from a direct radiating speaker (monopolar). Place these speakers at either side of the prime listening position, mounted above ear level.

**Path of the surround sound from the speakers to the listening position**

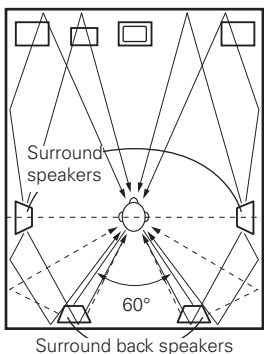

[As seen from above]

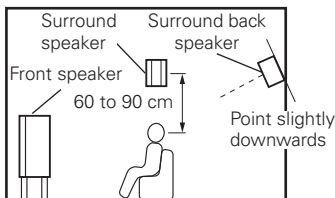

[As seen from the side]

③ **When playing movies and music**

To activate the appropriate speakers for movies and music, we suggest that during setup, choose Dolby Digital/DTS with THX and Surround Speakers A (the bipolar or dipolar speakers mounted at the sides of the listening position).

Choose Dolby Digital/DTS without THX and Surround Speakers B (the direct radiating speakers mounted at the rear corners of the listening room). Then, by simply activating the THX function (used during movie playback, the Surround A speakers are automatically activated. For multi-channel music listening (Dolby Digital or DTS music programs), turn off the THX enhancements by touching the THX button on the remote control, and the Surround B speakers will be automatically activated.

- Example:** Movie sources (Dolby, DTS Surround, etc.)  
 "THX" or "THX Cinema" mode ... Speakers A  
 Music sources (DVD video, DTS CD, etc.)  
 "Dolby/DTS Surround" ... Speakers B

The speakers can be switched at the touch of a button by turning HOME THX CINEMA on when playing movies and off when playing multi-channel music.

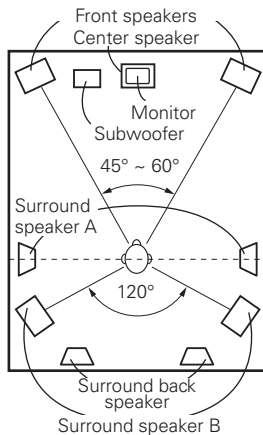

[As seen from above]

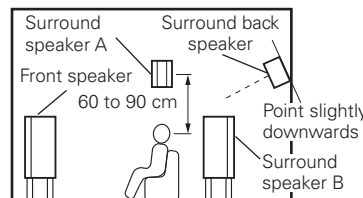

[As seen from the side]

**[2] When not using surround back speakers**

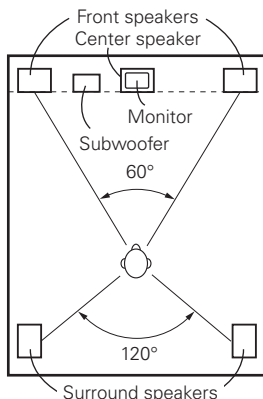

[As seen from above]

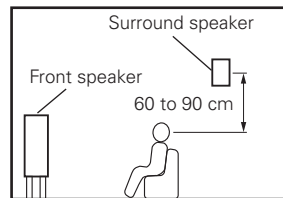

[As seen from the side]

**Surround**

The AVP-A1HD is equipped with a digital signal processing circuit that lets you play program sources in the surround mode to achieve the same sense of presence as in a movie theater.

**Dolby Surround**

**Dolby Digital**

Dolby Digital is a multichannel digital signal format developed by Dolby Laboratories.

A total of 5.1-channels are played: 3 front channels ("FL", "FR" and "C"), 2 surround channels ("SL" and "SR") and the "LFE" channel for low frequencies.

Because of this, there is no crosstalk between channels and a realistic sound field with a "three-dimensional" feeling (sense of distance, movement and positioning) is achieved.

A real, overpowering sense of presence is achieved when playing movie sources in AV rooms as well.

**Dolby Digital Plus**

Dolby Digital Plus is an improved Dolby Digital signal format that is compatible with up to 7.1-channels of discrete digital sound and also improves sound quality thanks to extra data bit rate performance. It is upwardly compatible with conventional Dolby Digital, so it offers greater flexibility in response to the source signal and the conditions of the playback equipment.

**Dolby TrueHD**

Dolby TrueHD is a high definition audio technology developed by Dolby Laboratories, using lossless coding technology to faithfully reproduce the sound of the studio master.

This format is compatible with a maximum sampling frequency of 96 kHz and up to 7.1-channels, so it is used for applications particularly prioritizing sound quality.

## **Dolby Pro Logic II**

Dolby Pro Logic II is a matrix decoding technology developed by Dolby Laboratories.

Regular music such as that on CDs is encoded into 5-channels to achieve an excellent surround effect.

The surround channel signals are converted into stereo and full band signals (with a frequency response of 20 Hz to 20 kHz or greater) to create a "three-dimensional" sound image offering a rich sense of presence for all stereo sources.

## **Dolby Pro Logic IIx**

Dolby Pro Logic IIx is a further improved version of the Dolby Pro Logic II matrix decoding technology.

Audio signals recorded in 2-channels are decoded to achieve a natural sound with up to 7.1-channels.

There are 3 modes: "Music" suited for playing music, "Cinema" suited for playing movies, and "Game" which is optimized for playing games.

## **Dolby Headphone**

This is a three-dimensional sound technology developed jointly by Dolby Laboratories and Lake Technology Ltd. of Australia for achieving surround sound using regular headphones.

Previously, when using headphones all the sounds resonated inside the head and it was uncomfortable to listen with headphones for long periods of time. Dolby Headphone simulates speaker playback in a room and places the sound at the front or the sides, outside the head, to achieve a powerful sound like the sound of movie or home theaters. This technology is mainly for multichannel audio/video equipment with Dolby Digital or Dolby Pro Logic Surround decoding functions and works with a high performance digital signal processing (DSP) chip.

Dolby Headphone is effective not only for multichannel sources but also for stereo programs.

On the AVP-A1HD, it is possible to output signals encoded in the Dolby Headphone mode from the recording output terminal and record them on a separate recorder.

### **※ Sources recorded in Dolby Surround**

Sources recorded in Dolby Surround are indicated with the following logo marks.

Dolby Surround support mark : 

Manufactured under license from Dolby Laboratories.  
"Dolby," "Pro Logic" and the double-D symbol are trademarks of Dolby Laboratories.

## **DTS Surround**

### **DTS Digital Surround**

DTS Digital Surround is the standard digital surround format of DTS, Inc., compatible with a sampling frequency of 44.1 or 48 kHz and up to 5.1-channels of digital discrete surround sound.

### **DTS-HD High Resolution Audio**

DTS-HD High Resolution Audio is an improved version of the conventional DTS, DTS-ES and DTS 96/24 signals formats, compatible with sampling frequencies of 96 or 48 kHz and up to 7.1-channels of discrete digital sound. High data bit rate performance provides high quality sound. This format is fully compatible with conventional products, including conventional DTS digital surround 5.1-channel data.

### **DTS-HD Master Audio**

DTS-HD Master Audio is DTS, Inc.'s lossless audio format compatible with up to 96 kHz/7.1-channels. The lossless audio coding technology faithfully reproduces the sound of the studio master. It is fully compatible with conventional products, including conventional DTS digital surround 5.1-channel data.

### **DTS-ES™ Discrete 6.1**

DTS-ES™ Discrete 6.1 is a 6.1-channel discrete digital audio format adding a surround back (SB) channel to the DTS digital surround sound. Decoding of conventional 5.1-channel audio signals is also possible according to the decoder.

### **DTS-ES™ Matrix 6.1**

DTS-ES™ Matrix 6.1 is a 6.1-channel discrete digital audio format inserting a surround back (SB) channel to the DTS digital surround sound through matrix encoding. Decoding of conventional 5.1-channel audio signals is also possible according to the decoder.

### **DTS NEO:6™ Surround**

DTS NEO:6™ is a matrix decoding technology for achieving 6.1-channel surround playback with 2-channel sources. It includes "DTS NEO:6 CINEMA" suited for playing movies and "DTS NEO:6 MUSIC" suited for playing music.

## **DTS 96/24**

DTS 96/24 is a digital audio format enabling high sound quality playback in 5.1-channels with a sampling frequency of 96 kHz and 24 bit quantization on DVD-Video.

Manufactured under license under U.S. Patent #'s: 5,451,942; 5,956,674; 5,974,380; 5,978,762; 6,226,616; 6,487,535 & other U.S. and worldwide patents issued & pending. DTS is a registered trademark and the DTS logos, Symbol, DTS-HD and DTS-HD Master Audio are trademarks of DTS, Inc. © 1996-2007 DTS, Inc. All Rights Reserved.

## **Home THX Cinema Surround**

THX is an exclusive set of standards and technologies established by the world-renowned film production company, Lucasfilm Ltd. THX grew from George Lucas' personal desire to make your experience of the film soundtrack, in both movie theaters and in your home theater, as faithful as possible to what the director intended.

Movie soundtracks are mixed in special movie theaters called dubbing stages and are designed to be played back in movie theaters with similar equipment and conditions. The soundtrack created for movie theaters is then transferred directly onto Laserdisc, VHS tape, DVD, etc., and is not changed for playback in a small home theater environment.

THX engineers developed patented technologies to accurately translate the sound from the movie theater environment into the home, correcting the tonal and spatial errors that occur. On the AVP-A1HD, when the Home THX Cinema mode is on, THX post-processing is automatically added after the Dolby Pro Logic, Dolby Digital or DTS decoder:

### **Re-EQ™ (Re-Equalization)**

The tonal balance of a film soundtrack will be excessively bright and harsh when played back over audio equipment in the home because film soundtracks are designed to be played back in large movie theaters using very different professional equipment. Re-Equalization restores the correct tonal balance for listening to a movie soundtrack in a normal home environment.

## Timbre Matching™

The human ear changes our perception of a sound depending on the direction from which the sound is coming. In a movie theater, there is an array of surround speakers so that the surround information is all around you. In a home theater, only two speakers located to the side of your head are used. The Timbre Matching feature filters the information going to the surround speakers so that they more closely match the tonal characteristics of the sound coming from the front speakers. This ensures seamless panning between the front and surround speakers.

## Adaptive Decorrelation™

In a movie theater, a large number of surround speakers help create an enveloping surround sound experience, while in a home theater there are usually only two speakers. This can make the surround speakers sound like headphones that lack spaciousness and envelopment. The surround sounds will also collapse into the closest speaker as you move away from the middle seating position. Adaptive Decorrelation slightly changes one surround channel's time and phase relationship with respect to the other surround channel. This expands the listening position and creates—with only two speakers—the same spacious surround experience as in a movie theater.

## THX Ultra2™

Before any home theater component can be THX Ultra2 certified, it must incorporate all the features above and also pass a rigorous series of quality and performance tests. Only then can a product feature the THX Ultra2 logo, which is your guarantee that the Home Theater products you purchase will give you superb performance for many years to come. THX Ultra2 requirements cover every aspect of the product including power amplifier performance, pre-amplifier performance and operation, as well as hundreds of other parameters in both the digital and analog domain.

In addition to improvements to the power amplifier with respect to previous THX Ultra standards, three surround modes have been added: the THX Ultra2 Cinema mode, THX Music Mode and THX Games Mode.

## THX Ultra2 Cinema

THX Ultra2 Cinema mode plays 5.1 movies using all 8 speakers giving you the best possible movie watching experience. In this mode, new THX processing blends the side surround speakers and back surround speakers providing the optimal mix of ambient and directional surround sounds.

DTS-ES (Matrix and 6.1 Discrete) and Dolby Digital Surround EX encoded soundtracks will be automatically detected in Ultra2 Cinema mode if the appropriate flag has been encoded.

Some Dolby Digital Surround EX soundtracks are missing the digital flag that allows automatic switching. If you know that the movie that you are watching is encoded in Surround EX, you can manually select the THX Surround EX playback mode, otherwise THX Ultra2 Cinema mode will apply processing to provide optimum replay.

## THX Music Mode

For the replay of 5.1 multi-channel music the THX Music Mode should be selected. In this mode new THX processing is applied to the surround channels of all 5.1 encoded music sources such as DTS and Dolby Digital to provide a wide stable rear soundstage.

## THX Games Mode

For the replay of stereo and multi-channel game audio the THX Games Mode should be selected. In this mode THX ASA processing is applied to the surround channels of all 5.1 and 2.0 encoded game sources such as analog, PCM, DTS and Dolby Digital. This accurately places all game audio surround information, providing a full 360 degree playback environment. THX Games Mode is unique as it gives you a smooth transition of audio in all points of the surround field.

## ASA (Advanced Speaker Array)

ASA is a proprietary THX technology which processes the sound fed to 2 side and 2 back surround speakers to provide the optimal surround sound experience. When you set up your home theater system using all eight speaker outputs (Left, Center, Right, Surround Right, Surround Back Right, Surround Back Left, Surround Left and Subwoofer) placing the two Surround Back speakers close together facing the front of the room as shown in the diagram will provide the largest sweet spot. If for practical reasons you have to place the Surround Back speakers apart, you will need to go THX Audio Set-up screen and choose the setting that most closely corresponds to the speaker spacing, which will re-optimize the surround sound-field.

ASA is used in three new modes; THX Ultra2 Cinema, THX Music Mode and THX Games Mode.

## Boundary Gain Compensation

If your chosen listening room layout (for practical or aesthetic reasons) results in the most of the listeners being close to the rear wall, the resulting bass level can be sufficiently reinforced by the boundary that the overall sound quality becomes “boomy”. THX Ultra2 receivers and controllers contain the BGC (Boundary Gain Compensation) feature to provide an improved bass balance. BGC can be selected by choosing “THX Ultra2 Subwoofer–Yes” from the “Boundary Gain Compensation” section of the THX Audio setup menu.

THX and Re-EQ, THX Timbre Matching, THX Adaptive Decorrelation, and THX Advanced Speaker Array are trademarks of THX Ltd. THX may be registered in some jurisdictions. All rights reserved.

## THX™ Surround EX™

In 1999, a new surround system was launched simultaneously with the release of the movie “Star Wars Episode I”. “Dolby Digital Surround EX” is a new movie sound track that greatly enhances the sense of spatial expression and the positioning of the surround channel sound. The result is 360 degrees of movement and moving sound effects that seem to pass right over the listener's head. This system was developed jointly by THX and Dolby Laboratories, fusing THX's idea of improving spatial expression and achieving a uniform 360 degree sound positioning with Dolby Laboratories' matrix encoding technology. Emphasis was placed on compatibility with the existing system Dolby Digital 5.1 channel, and the new “surround back (SB) channel” was added to achieve improvements over the conventional 5.1 channel system in terms of the positioning of the sound at the rear, the acoustic image of sound moving from the two sides to the back as well as sound moving from the front to the center rear with the multi surround speaker systems used in movie theaters, thereby enabling various types of surround sound. The surround back channel signal is a matrix-encoded signal inserted into both the Dolby Digital SL (surround left) and SR (surround right) channels. Upon playback, the signals are decoded by a high precision digital matrix decoder within the Dolby Digital decoder into the SL, SR and SB channels and output as 6.1 channels of signals. With the AVP-A1HD, the signals further undergo Home THX Cinema processing to achieve a THX Surround EX system. Even without the proper environment for playing the SB channel, Dolby Digital Surround EX signals are 100% compatible with existing 5.1 channel playback systems, so they can be played as such. In this case, the SB channel signal is produced as a monaural signal from both the SL and SR channels, so none of the signal components are missing. The effects specific to THX Surround EX (the sense of spatial expression and the positioning of the sound), however, are the same as with conventional 5.1 channel surround systems.

THX and Ultra2 are trademarks of THX Ltd. THX may be registered in some jurisdictions. All rights reserved. Surround EX is a trademark of Dolby Laboratories. Used with permission.

## Audyssey

### Audyssey MultEQ® XT

Audyssey MultEQ®XT is the first technology to properly measure sound information throughout a listening area, then combine this information to accurately represent the acoustical problems in the room. Based on these measurements, MultEQ XT calculates an equalization solution that corrects for both time and frequency response problems in every seat. Audyssey MultEQ XT not only corrects frequency response problem in a large listening area but also performs a fully automated surround system setup.

For a detailed description, see page 25.

### Audyssey Dynamic EQ™

Audyssey Dynamic EQ solves the problem of deteriorating sound quality as volume is decreased by taking into account human perception and room acoustics. Dynamic EQ selects the best possible frequency response and surround levels moment-by-moment as volume is changed. The result is bass response, tonal balance and surround impression that remain constant despite changes in volume. This is the first technology to combine information from incoming source levels with actual output sound levels in the room, a pre-requisite for delivering a loudness correction solution. Audyssey Dynamic EQ works in tandem with Audyssey MultEQ to provide well-balanced sound for every listener at any volume level.



Manufactured under license from Audyssey Laboratories. U.S. and foreign patents pending. Audyssey MultEQ® XT is a registered trademark of Audyssey Laboratories. Dynamic EQ™ is a trademark of Audyssey Laboratories.

For more information, visit [www.audyssey.com](http://www.audyssey.com).

## HDCD® (High Definition Compatible Digital®)

HDCD® is an encoding/decoding technology that greatly reduces the distortion that occurs upon digital recording while maintaining compatibility with the conventional CD format, thus expanding the dynamic range and achieving a high resolution.

Conventional CDs and HDCD compatible CDs are identified automatically to select the optimum digital processing.

HDCD®, HDCD®, High Definition Compatible Digital® and Microsoft® are either registered trademarks or trademarks of Microsoft Corporation, Inc. in the United States and/or other countries. HDCD system manufactured under license from Microsoft Corporation, Inc. This product is covered by one or more of the following: In the USA: 5,479,168, 5,638,074, 5,640,161, 5,808,574, 5,838,274, 5,854,600, 5,864,311, 5,872,531, and in Australia: 669114. Other patents pending.

## DENON LINK

DENON LINK is a unique digital, balanced transfer type interface developed by DENON. It offers high speed, high quality transfer of digital audio data with low signal loss. It can be used together with DENON DVD players equipped with a special DENON LINK connector using a single cable to enable playback with high sound quality.

It allows digital transfer of the 192 kHz/24 bit 2-channel digital signals of DVD-Audio discs, PCM multi-channel signals, etc. Full-spec digital transfer of the audio contents of Super Audio CD is possible by connecting a player equipped for DENON LINK 3rd Edition.

## Advanced AL24 Processing Multi channel

**Equipped with "Advanced AL24 Processing" time axis region information volume expansion**

In addition to the existing "AL24 Processing Plus" bit expansion technology, DENON has also developed "Advanced AL24 Processing" that dramatically improves information volume in the time axis region using high-speed signal detection and processing technology. In addition to expanding original 16-bit digital data to 24 bits, "Advanced AL24 Processing" uses data interpolation along the time axis or up-converted sampling to achieve natural interpolation without losing the original data. A digital filter is used to further expand adaptability and perform optimum filtering calculations for ringing-free pulse response, pulsive music data and attack sounds.

This results in the reproduction of such spatial information as the delicate nuances in the music, the positions of the performers, and the breadth, height, and depth of the concert hall. "Advanced AL24 Processing" is conducted for all channels and modes other than DSD DIRECT.

## HDMI (High-Definition Multimedia Interface)

HDMI is a digital interface standard for next generation TVs based on DVI (Digital Visual Interface) standards and optimized for use in consumer equipment.

Non-compressed digital video and multi-channel audio signals are transmitted with a single connection.

HDMI is also compatible with HDCP (High-bandwidth Digital Contents Protection), a technology for protecting copyrights that encrypts digital video signals in the same way as with DVI.

### Deep Color

Eliminates on-screen color banding, for smooth tonal transitions and subtle gradations between colors.

Enables increased contrast ratio.

Can represent many times more shades of gray between black and white.

At 30-bit pixel depth, a four times improvement would be the minimum, and the typical improvement would be eight times or more.

### xvYCC

Next-generation "xvYCC" color space supports 1.8 times as many colors as existing HDTV signals.

Lets HDTVs display colors more accurately.

Enables displays with natural, vivid colors.

### Lip Sync

Because consumer electronics devices are using increasingly complex digital signal processing to enhance the clarity and detail of the content, synchronization of video and audio in user devices has become a greater challenge and could potentially require complex end-user adjustments. HDMI 1.3 incorporates an automatic video/audio syncing capability that allows devices to perform this synchronization automatically with total accuracy.

"HDMI", "HDMI logo" and "High-Definition Multimedia Interface" are trademarks or registered trademarks of HDMI Licensing LLC.

## Surround Modes and Parameters

Surround Mode	Signals and adjustability in the different modes										
	Channel output					Parameter (default values are shown in parentheses)					
	Front L/R	Center	Surround L/R	Surround Back L/R	Subwoofer	D. COMP *1	DRC *2	LFE *3	AFDM *1	SB CH Out	Cinema EQ.
PURE DIRECT, DIRECT	○	×	×	×	⊙	○ (OFF)	○ (Auto)	○ (0 dB)	×	×	×
DSD DIRECT	○	×	×	×	×	×	×	×	×	×	×
DSD MULTI DIRECT	○	⊙	⊙	⊙	⊙	×	×	○ (0 dB)	×	○	×
MULTI CH DIRECT	○	⊙	⊙	⊙	⊙	×	×	○ (0 dB)	○ (ON)	○	×
STEREO	○	×	×	×	⊙	○ (OFF)	○ (Auto)	○ (0 dB)	×	×	×
EXT. IN	○	⊙	⊙	⊙	⊙	×	×	×	×	○ (NOTE6)	×
MULTI CH IN	○	⊙	⊙	⊙	⊙	×	×	○ (0 dB)	○ (ON)	○	×
WIDE SCREEN	○	⊙	⊙	⊙	⊙	○ (OFF)	○ (Auto)	○ (0 dB)	×	○	○ (OFF)
HOME THX CINEMA (2ch)	○	⊙	⊙	⊙	⊙	×	×	×	×	○	×
HOME THX CINEMA (5.1ch)	○	⊙	⊙	⊙	⊙	×	×	○ (0 dB)	○ (ON)	○	×
DOLBY PRO LOGIC IIx	○	⊙	⊙	⊙	⊙	○ (OFF)	○ (Auto)	×	×	○	○ (NOTE1)
DOLBY PRO LOGIC II	○	⊙	⊙	×	⊙	○ (OFF)	○ (Auto)	×	×	○	○ (NOTE2)
DTS NEO:6	○	⊙	⊙	⊙	⊙	○ (OFF)	○ (Auto)	×	×	○	○ (NOTE1)
DOLBY DIGITAL	○	⊙	⊙	⊙	⊙	○ (OFF)	○ (Auto)	○ (0 dB)	○ (ON)	○	○ (OFF)
DTS SURROUND	○	⊙	⊙	⊙	⊙	○ (OFF)	○ (Auto)	○ (0 dB)	○ (ON)	○	○ (OFF)
7CH STEREO	○	⊙	⊙	⊙	⊙	○ (OFF)	○ (Auto)	○ (0 dB)	×	○	×
SUPER STADIUM	○	⊙	⊙	⊙	⊙	○ (OFF)	○ (Auto)	○ (0 dB)	×	○	×
ROCK ARENA	○	⊙	⊙	⊙	⊙	○ (OFF)	○ (Auto)	○ (0 dB)	×	○	×
JAZZ CLUB	○	⊙	⊙	⊙	⊙	○ (OFF)	○ (Auto)	○ (0 dB)	×	○	×
CLASSIC CONCERT	○	⊙	⊙	⊙	⊙	○ (OFF)	○ (Auto)	○ (0 dB)	×	○	×
MONO MOVIE	○	⊙	⊙	⊙	⊙	○ (OFF)	○ (Auto)	○ (0 dB)	×	○	×
VIDEO GAME	○	⊙	⊙	⊙	⊙	○ (OFF)	○ (Auto)	○ (0 dB)	×	○	×
MATRIX	○	⊙	⊙	⊙	⊙	○ (OFF)	○ (Auto)	○ (0 dB)	×	○	×
DOLBY HEADPHONE	○	×	×	×	×	×	×	×	×	×	×

○ : Signal / Adjustable

× : No signal / Not adjustable

⊙ : Turned on or off by speaker configuration setting

NOTE1 : This parameter is available when the GUI menu "Parameter" - "Audio" - "Surround Parameters" - "Mode" is set to "Cinema" (page 48).

NOTE2 : This parameter is available when the GUI menu "Parameter" - "Audio" - "Surround Parameters" - "Mode" is set to "Cinema" or "Pro Logic" (page 48).

NOTE6 : This parameter can be used when GUI menu "Manual Setup" - "Audio Setup" - "EXT. IN Setup" - "Mode" is set to "DSP" (page 32)

#### NOTE:

\*1 : When playing Dolby Digital and DTS signals.

\*2 : When playing Dolby True HD signal.

\*3 : When playing Dolby Digital, DTS, DVD-Audio and Super Audio CD.

Surround Mode	Signals and adjustability in the different modes																
	Parameter (default values are shown in parentheses)																
	Mode	Decoder	Room Size	Effect Level	Delay Time	Subwoofer	PRO LOGIC II/IIx MUSIC mode only			NEO:6 MUSIC mode only	EXT. IN only		Tone	Night Mode	Room EQ	Dynamic EQ*	RESTORER
Panorama							Dimension	Center Width	Center Image	Subwoofer Att.	Input Channel						
PURE DIRECT, DIRECT	×	×	×	×	×	○	×	×	×	×	×	×	×	○ (OFF)	○ (NOTE5)	○ (NOTE5)	○
DSD DIRECT	×	×	×	×	×	○	×	×	×	×	×	×	×	×	×	×	×
DSD MULTI DIRECT	×	×	×	×	×	×	×	×	×	×	×	×	×	×	×	×	×
MULTI CH DIRECT	×	×	×	×	×	×	×	×	×	×	×	×	×	○ (OFF)	○ (NOTE5)	○ (NOTE5)	×
STEREO	×	×	×	×	×	×	×	×	×	×	×	×	○ (0 dB)	○ (OFF)	○ (OFF)	○ (OFF)	○
EXT. IN	×	×	×	×	×	×	×	×	×	×	○	○ (NOTE6)	×	×	×	×	×
MULTI CH IN	×	×	×	×	×	×	×	×	×	×	×	×	○ (0 dB)	○ (OFF)	○ (OFF)	○ (OFF)	×
WIDE SCREEN	×	×	×	○ (ON, 10)	×	×	×	×	×	×	×	×	○ (0 dB)	○ (OFF)	○ (OFF)	○ (OFF)	○
HOME THX CINEMA (2ch)	○ (PLIIx C)	○	×	×	×	×	×	×	×	×	×	×	×	○ (OFF)	○ (OFF)	○ (OFF)	○
HOME THX CINEMA (5.1ch)	×	×	×	×	×	×	×	×	×	×	×	×	×	○ (OFF)	○ (OFF)	○ (OFF)	×
DOLBY PRO LOGIC IIx	○ (Cinema)	×	×	×	×	×	○ (OFF)	○ (3)	○ (3)	×	×	×	○ (0 dB)	○ (OFF)	○ (OFF)	○ (OFF)	○
DOLBY PRO LOGIC II	○ (Cinema)	×	×	×	×	×	○ (OFF)	○ (3)	○ (3)	×	×	×	○ (0 dB)	○ (OFF)	○ (OFF)	○ (OFF)	○
DTS NEO:6	○ (Cinema)	×	×	×	×	×	×	×	×	○ (0.3)	×	×	○ (0 dB)	○ (OFF)	○ (OFF)	○ (OFF)	○
DOLBY DIGITAL	×	×	×	×	×	×	×	×	×	×	×	×	○ (0 dB)	○ (OFF)	○ (OFF)	○ (OFF)	×
DTS SURROUND	×	×	×	×	×	×	×	×	×	×	×	×	○ (0 dB)	○ (OFF)	○ (OFF)	○ (OFF)	×
7CH STEREO	×	×	×	×	×	×	×	×	×	×	×	×	○ (0 dB)	○ (OFF)	○ (OFF)	○ (OFF)	○
SUPER STADIUM	×	×	○ (Medium)	○ (10)	×	×	×	×	×	×	×	×	○ (NOTE3)	○ (OFF)	○ (OFF)	○ (OFF)	○
ROCK ARENA	×	×	○ (Medium)	○ (10)	×	×	×	×	×	×	×	×	○ (NOTE4)	○ (OFF)	○ (OFF)	○ (OFF)	○
JAZZ CLUB	×	×	○ (Medium)	○ (10)	×	×	×	×	×	×	×	×	○ (0 dB)	○ (OFF)	○ (OFF)	○ (OFF)	○
CLASSIC CONCERT	×	×	○ (Medium)	○ (10)	×	×	×	×	×	×	×	×	○ (0 dB)	○ (OFF)	○ (OFF)	○ (OFF)	○
MONO MOVIE	×	×	○ (Medium)	○ (0)	×	×	×	×	×	×	×	×	○ (0 dB)	○ (OFF)	○ (OFF)	○ (OFF)	○
VIDEO GAME	×	×	○ (Medium)	○ (10)	×	×	×	×	×	×	×	×	○ (0 dB)	○ (OFF)	○ (OFF)	○ (OFF)	○
MATRIX	×	×	×	×	○ (30 ms)	×	×	×	×	×	×	×	○ (0 dB)	○ (OFF)	○ (OFF)	○ (OFF)	○
DOLBY HEADPHONE	×	○	×	×	×	×	×	×	×	×	×	×	○ (0 dB)	○ (OFF)	○ (OFF)	○ (OFF)	○

○ : Signal / Adjustable

×

NOTE3 : BASS +6 dB, TREBLE 0 dB

NOTE4 : BASS +6 dB, TREBLE +4 dB

NOTE5 : Can be used according to the "Direct Mode" setting.

NOTE6 : "DSP" mode only

\* : Can be set when GUI menu "Parameter" - "Audio" - "Room EQ" (page 51) is set to "Audyssey", "Audyssey Flat", "Audyssey Byp.L/R".

Differences in Surround Mode Names Depending on the Input Signals

Button	Surround mode	Note	Input signals																
			ANALOG	LINEAR PCM / WAV	WMA (Windows Media Audio) / MP3 / MPEG-4 AAC / FLAC	DTS				DOLBY DIGITAL					DVD-AUDIO		Super Audio CD		
						DTS ES DSCRT (With Flag)	DTS ES MTRX (With Flag)	DTS (5.1ch)	DTS 96/24	DOLBY DIGITAL EX (With Flag)	DOLBY DIGITAL EX (With no Flag)	DOLBY DIGITAL (5.1/5/4ch)	DOLBY DIGITAL (4/3ch)	DOLBY DIGITAL (2ch)	DVD-Audio (multi ch)	DVD-Audio (2ch)	DSD (multi ch)	DSD (2ch)	
HOME THX CINEMA																			
	ES DSCRT6.1 + THX	*1	×	×	×	◎	×	×	×	×	×	×	×	×	×	×	×	×	×
	ES MTRX6.1 + THX	*1	×	×	×	×	◎	○	○	×	×	×	×	×	×	×	×	×	×
	THX SURROUND EX	*1	×	×	×	×	×	×	×	◎	○	○	○	×	○	×	○	×	×
	THX Ultra2 Cinema	*2	×	×	×	○	○	○	○	○	○	○	○	×	○	×	○	×	×
	THX Music Mode	*2	×	×	×	○	○	○	○	○	○	○	○	×	○	×	○	×	×
	THX Games Mode	*2	○	○	○	○	○	○	○	○	○	○	○	○	○	○	○	○	○
	THX Cinema		×	×	×	○	○	○	○	○	○	○	○	×	○	×	○	×	×
	PLIIx C + THX	*3	○	○	○	○	○	○	○	○	○	○	○	○	○	○	○	○	○
	PLII C + THX		○	○	○	×	×	×	×	×	×	×	×	○	×	○	×	○	○
	DOLBY PL + THX		○	○	○	×	×	×	×	×	×	×	×	○	×	○	×	○	○
	NEO:6 + THX		○	○	○	×	×	×	×	×	×	×	×	○	×	○	×	○	○
	MULTI CH 7.1 + THX		×	×	×	×	×	×	×	×	×	×	×	×	○ (7.1)	×	×	×	×
	MULTI CH 5.1 + THX		×	×	×	×	×	×	×	×	×	×	×	×	○	×	○	×	×
STANDARD																			
DTS SURROUND																			
	DTS ES DSCRT6.1	*1	×	×	×	●◎	×	×	×	×	×	×	×	×	×	×	×	×	×
	DTS ES MTRX6.1	*1	×	×	×	×	●◎	×	×	×	×	×	×	×	×	×	×	×	×
	DTS SURROUND		×	×	×	○	○	●	×	×	×	×	×	×	×	×	×	×	×
	DTS 96/24		×	×	×	×	×	×	●	×	×	×	×	×	×	×	×	×	×
	DTS + PLIIx CINEMA	*2	×	×	×	○	○	○	○	×	×	×	×	×	×	×	×	×	×
	DTS + PLIIx MUSIC	*1	×	×	×	○	○	○	○	×	×	×	×	×	×	×	×	×	×
	DTS + NEO:6	*1	×	×	×	×	○	○	○	×	×	×	×	×	×	×	×	×	×
	DTS NEO:6 CINEMA		○	○	○	×	×	×	×	×	×	×	×	○	×	○	×	○	○
	DTS NEO:6 MUSIC		○	○	○	×	×	×	×	×	×	×	×	○	×	○	×	○	○

NOTE:

\*1: This mode is not available when the surround back speaker setup is set to "None".

\*2: This mode is not available when the surround back speaker setup is set to "1spkr" or "None".

\*3: For input signals other than 2 channel signals, this mode cannot be selected when surround back speaker is set to "1spkr" or "None".

● : Mode selectable in initial status

◎ : Mode fixed when "AFDM" is "ON"

○ : Selectable mode

× : Non-selectable mode



Button	Surround mode	Note	Input signals															
			ANALOG	LINEAR PCM / WAV	WMA (Windows Media Audio) / MP3 / MPEG-4 AAC / FLAC	DTS				DOLBY DIGITAL					DVD-AUDIO		Super Audio CD	
						DTS ES DSCRT (With Flag)	DTS ES MTRX (With Flag)	DTS (5.1ch)	DTS 96/24	DOLBY DIGITAL EX (With Flag)	DOLBY DIGITAL EX (With no Flag)	DOLBY DIGITAL (5.1/5/4ch)	DOLBY DIGITAL (4/3ch)	DOLBY DIGITAL (2ch)	DVD-Audio (multi ch)	DVD-Audio (2ch)	DSD (multi ch)	DSD (2ch)
STANDARD																		
DOLBY SURROUND																		
	DOLBY DIGITAL EX	*1	×	×	×	×	×	×	×	○	○	○	○	×	×	×	×	
	DOLBY DIGITAL		×	×	×	×	×	×	×	○	●	●	●	×	×	×	×	
	DOLBY DIGITAL + PLIIx CINEMA	*2	×	×	×	×	×	×	×	● ◎	○	○	○	×	×	×	×	
	DOLBY DIGITAL + PLIIx MUSIC	*1	×	×	×	×	×	×	×	○	○	○	○	×	×	×	×	
	DOLBY PRO LOGIC IIx CINEMA		○	○	○	×	×	×	×	×	×	×	×	●	×	○	×	
	DOLBY PRO LOGIC IIx MUSIC		○	○	○	×	×	×	×	×	×	×	×	○	×	○	×	
	DOLBY PRO LOGIC IIx GAME		○	○	○	×	×	×	×	×	×	×	×	○	×	○	×	
	DOLBY PRO LOGIC II CINEMA		○	○	○	×	×	×	×	×	×	×	×	○	×	○	×	
	DOLBY PRO LOGIC II MUSIC		○	○	○	×	×	×	×	×	×	×	×	○	×	○	×	
	DOLBY PRO LOGIC II GAME		○	○	○	×	×	×	×	×	×	×	×	○	×	○	×	
	DOLBY PRO LOGIC		○	○	○	×	×	×	×	×	×	×	×	○	×	○	×	
	DOLBY HEADPHONE	*4	○	○	○	○	○	○	○	○	○	○	○	○	○	○	○	
MULTI CH IN																		
	MULTI CH IN		×	×	×	×	×	×	×	×	×	×	×	×	●	×	●	
	MULTI IN + PLIIx CINEMA	*2	×	×	×	×	×	×	×	×	×	×	×	×	○	×	○	
	MULTI IN + PLIIx MUSIC	*1	×	×	×	×	×	×	×	×	×	×	×	×	○	×	○	
	MULTI CH IN 7.1		×	×	×	×	×	×	×	×	×	×	×	×	● ◎ (7.1)	×	×	
DIRECT																		
	DIRECT		○	○	○	○	○	○	○	○	○	○	○	○	×	○	×	
	DSD DIRECT		×	×	×	×	×	×	×	×	×	×	×	×	×	×	○	
	DSD MULTI DIRECT		×	×	×	×	×	×	×	×	×	×	×	×	×	○	×	
	MULTI CH DIRECT		×	×	×	×	×	×	×	×	×	×	×	×	○	×	○	
	M DIRECT + PLIIx CINEMA	*2	×	×	×	×	×	×	×	×	×	×	×	×	○	×	○	
	M DIRECT + PLIIx MUSIC	*1	×	×	×	×	×	×	×	×	×	×	×	×	○	×	○	
	M DIRECT 7.1		×	×	×	×	×	×	×	×	×	×	×	×	○	×	×	

**NOTE:**

- \*1: This mode is not available when the surround back speaker setup is set to "None".
- \*2: This mode is not available when the surround back speaker setup is set to "1spkr" or "None".
- \*4: This mode is available when headphones are connected to the PHONE jack.

- : Mode selectable in initial status
- ◎ : Mode fixed when "AFDM" is "ON"
- : Selectable mode
- ×

Button	Surround mode	Note	Input signals																
			ANALOG	LINEAR PCM / WAV	WMA (Windows Media Audio) / MP3 / MPEG-4 AAC / FLAC	DTS				DOLBY DIGITAL					DVD-AUDIO		Super Audio CD		
						DTS ES DSCRT (With Flag)	DTS ES MTRX (With Flag)	DTS (5.1ch)	DTS 96/24	DOLBY DIGITAL EX (With Flag)	DOLBY DIGITAL EX (With no Flag)	DOLBY DIGITAL (5.1/5/4ch)	DOLBY DIGITAL (4/3ch)	DOLBY DIGITAL (2ch)	DVD-Audio (multi ch)	DVD-Audio (2ch)	DSD (multi ch)	DSD (2ch)	
PURE DIRECT																			
	PURE DIRECT		○	○	○	○	○	○	○	○	○	○	○	○	○	×	○	×	○
	DSD PURE DIRECT		×	×	×	×	×	×	×	×	×	×	×	×	×	×	×	○	
	DSD MULTI PURE		×	×	×	×	×	×	×	×	×	×	×	×	×	×	○	×	
	MULTI CH PURE DIRECT		×	×	×	×	×	×	×	×	×	×	×	×	○	×	○	×	
	M PURE D + PLIIx CINEMA	*2	×	×	×	×	×	×	×	×	×	×	×	×	○	×	○	×	
	M PURE D + PLIIx MUSIC	*1	×	×	×	×	×	×	×	×	×	×	×	×	○	×	○	×	
	M CH PURE DIRECT 7.1		×	×	×	×	×	×	×	×	×	×	×	×	○	×	×	×	
DSP SIMULATION																			
	7CH STEREO	*5	○	○	○	○	○	○	○	○	○	○	○	○	○	○	○	○	
	WIDE SCREEN		○	○	○	○	○	○	○	○	○	○	○	○	○	○	○	○	
	SUPER STADIUM		○	○	○	○	○	○	○	○	○	○	○	○	○	○	○	○	
	ROCK ARENA		○	○	○	○	○	○	○	○	○	○	○	○	○	○	○	○	
	JAZZ CLUB		○	○	○	○	○	○	○	○	○	○	○	○	○	○	○	○	
	CLASSIC CONCERT		○	○	○	○	○	○	○	○	○	○	○	○	○	○	○	○	
	MONO MOVIE		○	○	○	○	○	○	○	○	○	○	○	○	○	○	○	○	
	VIDEO GAME		○	○	○	○	○	○	○	○	○	○	○	○	○	○	○	○	
	MATRIX		○	○	○	○	○	○	○	○	○	○	○	○	○	○	○	○	
STEREO																			
	STEREO		●	●	●	○	○	○	○	○	○	○	○	○	○	●	○	●	

**NOTE :**

- \*1: This mode is not available when the surround back speaker setup is set to "None".
- \*2: This mode is not available when the surround back speaker setup is set to "1spkr" or "None".
- \*5: If the surround back speaker setup is set to "None" and when using headphones, then "5CH STEREO" is displayed. "9CH STEREO" is displayed when surround (A+B) and the surround back speaker are used.

- : Mode selectable in initial status
- : Selectable mode
- ×

## About Networks

### Windows Media Player Ver. 11

This is a media player distributed free of charge by Microsoft Corporation.

It can be used to play playlists created with Windows Media Player ver. 11 as well as files in such formats as WMA, DRM WMA, MP3 and WAV.

### vTuner

This is a free online contents server for Internet radio. Note that usage fees are included in upgrade costs.

For inquiries about this service, visit the vTuner site below.

vTuner website: <http://www.radiodenon.com>

This product is protected by certain intellectual property rights of Nothing Else Matters Software and BridgeCo. Use or distribution of such technology outside of this product is prohibited without a license from Nothing Else Matters Software and BridgeCo or an authorized subsidiary.

### DLNA

- DLNA and DLNA CERTIFIED are trademarks and/or service marks of Digital Living Network Alliance.
- Some contents may not be compatible with other DLNA CERTIFIED™ products.

### Windows Media DRM

A copyright-protected technology developed by Microsoft.

- Windows Vista and the Windows logo are trademarks of the Microsoft group of companies.
- The PlaysForSure logo, Windows Media and the Windows logo are trademarks or registered trademarks of Microsoft Corporation in the United States and/or other countries.
- Content providers are using the digital rights management technology for Windows Media contained in this device (WM-DRM) to protect the integrity of their content (Secure Content) so that their intellectual property, including copyright, in such content is not misappropriated. This device uses WM-DRM software to play Secure Content (WM-DRM Software). If the security of the WM-DRM Software in this device has been compromised, owners of Secure Content (Secure Content Owners) may request that Microsoft revoke the WM-DRM Software's right to acquire new licenses to copy, display and/or play Secure Content. Revocation does not alter the WM-DRM Software's ability to play unprotected content. A list of revoked WM-DRM Software is sent to your device whenever you download a license for Secure Content from the Internet or from a PC. Microsoft may, in conjunction with such license, also download revocation list onto your device on behalf of Secure Content Owners.

### About Wireless LAN

#### Wi-Fi®

Wi-Fi Certification assures tested and proven interoperability by the Wi-Fi Alliance, a group certifying interoperability among wireless LAN devices.

#### IEEE 802.11b

This is one wireless LAN standard set by the 802 working group that establishes LAN technology standards at the IEEE (Institute of Electrical and Electronics Engineers) of the United States. It uses the 2.4 GHz band usable freely without a radio frequency license (ISM band), enabling communications at a maximum speed of 11 Mbps.



The value indicated above is the maximum theoretical value for the wireless LAN standard, and does not indicate the actual data transfer rate.

#### IEEE 802.11g

This is another wireless LAN standard set by the 802 working group that establishes LAN technology standards at the IEEE (Institute of Electrical and Electronics Engineers) of the United States, and is compatible with IEEE 802.11b. It also uses the 2.4 GHz band, but enables communications at a maximum speed of 54 Mbps.



The value indicated above is the maximum theoretical value for the wireless LAN standard, and does not indicate the actual data transfer rate.

#### Infrastructure Communications

"Infrastructure Communications" refers to networks using wireless LAN access points.

This function can be used to connect to the Internet or a wired LAN via a wireless LAN access point. Wireless LAN access points include wireless broadband routers.

#### Ad-hoc Communications

Signal transfer through wireless interconnection of computers is referred to as "ad hoc communications." With such ad hoc communications there is no connection to the Internet. Ad hoc communications are suited for establishing simple temporary networks.

#### Network Names (SSID: Security Set Identifier)

When forming wireless LAN networks, groups are formed to prevent interference, data theft, etc. This grouping is done by "SSID" or "Security Set Identifiers." For further security, a WEP key is set and signal transfer is not possible unless the SSID and WEP key match.

#### WEP Key (Network Key)

This is key information used for encrypting data when conducting data transfer. On the AVP-A1HD, the same WEP key is used for data encryption and decryption, so the same WEP key must be set on both devices in order for communications to be established between them.

### **WPA (Wi-Fi Protected Access)**

This is a security standard established by the Wi-Fi Alliance. In addition to the conventional SSID (network name) and WEP key (network key), it also uses a user identification function and encrypting protocol for stronger security.

### **WPA2 (Wi-Fi Protected Access 2)**

This is a new version of the WPA established by the Wi-Fi Alliance, compatible with more secure AES encryption.

### **WPA-PSK/WPA2-PSK (Pre-shared Key)**

This is a simple authentication system for mutual authentication when a preset character string matches on the wireless LAN access point and client.

### **Passphrase**

This refers to the code key used for WPA-PSK/WPA2-PSK authentication, a WPA authentication method.

### **TKIP (Temporal Key Integrity Protocol)**

This is a network key used for WPA. The encryption algorithm is RC4, the same as for WEP, but the security level is increased by changing the network key used for encryption for each packet.

### **AES (Advanced Encryption Standard)**

This is a next generation standard encryption method replacing the current DES and 3DES, and because of its high security it is expected to be applied widely to wireless LANs in the future. It uses the "Rijndael" algorithm developed by two Belgian cryptographers to divide the data into blocks of fixed lengths and encrypt each block. It supports data lengths of 128, 192 and 256 bits and key lengths of 128, 192 and 256 bits as well, offering extremely high encryption security.



# Relationship Between Video Signals and Monitor Output

## MAIN ZONE

Video Convert	Input signal				Monitor output				Monitor output (when GUI menu displayed)				
	HDMI	COMPONENT	S-VIDEO	VIDEO	HDMI	COMPONENT	S-VIDEO	VIDEO	HDMI	COMPONENT	S-VIDEO	VIDEO	
ON	With HDMI monitor	○	×	×	×	※				※ *4			
		×	×	×	○	※ VIDEO *1	VIDEO *1	VIDEO *1 *5	VIDEO *1 *5	※ VIDEO *3	VIDEO *3	VIDEO *3	VIDEO *3
		×	×	×	×	※ S-VIDEO *1	S-VIDEO *1	S-VIDEO *1	S-VIDEO *1	※ S-VIDEO *3	S-VIDEO *3	S-VIDEO *3	S-VIDEO *3
		×	×	○	○	※ S-VIDEO *1	S-VIDEO *1	S-VIDEO *1	S-VIDEO *1	※ S-VIDEO *3	S-VIDEO *3	S-VIDEO *3	S-VIDEO *3
		×	○ (1080p)	×	×	×	COMPONENT	×	×	※ *4	*4	*4	*4
		×	○ (480p ~ 720p)	×	×	※ COMPONENT *1	COMPONENT *1	×	×	※ COMPONENT *3	COMPONENT *3	×	×
		×	○ (480i/576i)	×	×	※ COMPONENT *1	COMPONENT *1	COMPONENT *1	COMPONENT *1	※ COMPONENT *3	COMPONENT *3	COMPONENT *3	COMPONENT *3
		×	○ (1080p)	×	○	※ VIDEO *1	COMPONENT	VIDEO *1 *5	VIDEO *1 *5	※ VIDEO *3	VIDEO *3	VIDEO *3	VIDEO *3
		×	○ (480p ~ 720p)	×	○	※ COMPONENT *1	COMPONENT *1	×	VIDEO	※ COMPONENT *3	COMPONENT *3	×	VIDEO
		×	○ (480i/576i)	×	○	※ COMPONENT *1	COMPONENT *1	COMPONENT *1	COMPONENT *1	※ COMPONENT *3	COMPONENT *3	COMPONENT *3	COMPONENT *3
		×	○ (1080p)	○	×	※ S-VIDEO *1	COMPONENT	S-VIDEO *1	S-VIDEO *1	※ S-VIDEO *3	S-VIDEO *3	S-VIDEO *3	S-VIDEO *3
		×	○ (480p ~ 720p)	○	×	※ COMPONENT *1	COMPONENT *1	S-VIDEO	S-VIDEO	※ COMPONENT *3	COMPONENT *3	S-VIDEO	S-VIDEO
		×	○ (480i/576i)	○	×	※ COMPONENT *1	COMPONENT *1	COMPONENT *1	COMPONENT *1	※ COMPONENT *3	COMPONENT *3	COMPONENT *3	COMPONENT *3
		×	○ (1080p)	○	○	※ S-VIDEO *1	COMPONENT	S-VIDEO *1	S-VIDEO *1	※ S-VIDEO *3	S-VIDEO *3	S-VIDEO *3	S-VIDEO *3
		×	○ (480p ~ 720p)	○	○	※ COMPONENT *1	COMPONENT *1	S-VIDEO	S-VIDEO	※ COMPONENT *3	COMPONENT *3	S-VIDEO	S-VIDEO
	×	○ (480i/576i)	○	○	※ COMPONENT *1	COMPONENT *1	COMPONENT *1	COMPONENT *1	※ COMPONENT *3	COMPONENT *3	COMPONENT *3	COMPONENT *3	
	Without HDMI monitor or with HDMI monitor off	○	×	×	×	HDMI *2	×	×	×	HDMI *3	×	×	×
		○	×	×	○	HDMI *2	VIDEO *1	VIDEO *1 *5	VIDEO *1 *5	HDMI *3	VIDEO	VIDEO	VIDEO
		○	×	○	×	HDMI *2	S-VIDEO *1	S-VIDEO *1	S-VIDEO *1	HDMI *3	S-VIDEO	S-VIDEO	S-VIDEO
		○	×	○	×	HDMI *2	S-VIDEO *1	S-VIDEO *1	S-VIDEO *1	HDMI *3	S-VIDEO	S-VIDEO	S-VIDEO
		○	○ (1080p)	×	×	HDMI *2	COMPONENT	×	×	HDMI *3	COMPONENT	×	×
		○	○ (480p ~ 720p)	×	×	HDMI *2	COMPONENT *1	×	×	HDMI *3	COMPONENT	×	×
		○	○ (480i/576i)	×	×	HDMI *2	COMPONENT *1	COMPONENT *1	COMPONENT *1	HDMI *3	COMPONENT	COMPONENT	COMPONENT
		○	○ (1080p)	×	○	HDMI *2	COMPONENT	VIDEO *1 *5	VIDEO *1 *5	HDMI *3	COMPONENT	VIDEO	VIDEO
		○	○ (480p ~ 720p)	×	○	HDMI *2	COMPONENT *1	×	VIDEO	HDMI *3	COMPONENT	×	VIDEO
		○	○ (480i/576i)	×	○	HDMI *2	COMPONENT *1	COMPONENT *1	COMPONENT *1	HDMI *3	COMPONENT	COMPONENT	COMPONENT
		○	○ (1080p)	○	×	HDMI *2	COMPONENT	S-VIDEO *1	S-VIDEO *1	HDMI *3	COMPONENT	S-VIDEO	S-VIDEO
		○	○ (480p ~ 720p)	○	×	HDMI *2	COMPONENT *1	S-VIDEO	S-VIDEO	HDMI *3	COMPONENT	S-VIDEO	S-VIDEO
		○	○ (480i/576i)	○	○	HDMI *2	COMPONENT *1	COMPONENT *1	COMPONENT *1	HDMI *3	COMPONENT	COMPONENT	COMPONENT
		○	○ (1080p)	○	○	HDMI *2	COMPONENT	S-VIDEO *1	S-VIDEO *1	HDMI *3	COMPONENT	S-VIDEO	S-VIDEO
○		○ (480p ~ 720p)	○	○	HDMI *2	COMPONENT *1	S-VIDEO	S-VIDEO	HDMI *3	COMPONENT	S-VIDEO	S-VIDEO	
○	○ (480i/576i)	○	○	HDMI *2	COMPONENT *1	COMPONENT *1	COMPONENT *1	HDMI *3	COMPONENT	COMPONENT	COMPONENT		

○ : Signal present  
 × : No signal  
 480p ~ 720p : 480p / 576p / 1080i / 720p

× : No output  
 \*1 : The "Picture Adjust" setting can be made ("Contrast", "Brightness", "Chroma Level", "Hue").  
 \*2 : The "Picture Adjust" setting can be made ("DNR", "Enhancer", "Sharpness").  
 \*3 : Superimposed over video signal  
 \*4 : Only displayed when the **MENU** button is pressed  
 \*5 : If the input signal is in SECAM format, it is converted to PAL for output

※ : Output according to "Resolution" setting (i/p Scaler : When "A to H" is set) (page 45).  
 : Wallpaper or set background color displayed  
 : Output according to "Resolution" setting (i/p Scaler : When "H to H" is set) (page 45).  
 : GUI menu not displayed

- The MAIN ZONE video conversion function is compatible with the following formats: NTSC, PAL, SECAM, NTSC4,43, PAL -N, PAL -M and PAL -60.
- When SECAM signals of video input are up-converted, the signals are output in PAL format from the S-Video connector.
- If the input signal is a component 1080p signal, up-converting to HDMI is not possible.
- The GUI menu display cannot be superimposed when xvYCC signals and component 1080p signal, computer's resolution (e.g. VGA) are input.

Getting Started  
 Connections  
 Setup  
 Playback  
 Remote Control  
 Multi-Zone  
 Information  
 Troubleshooting

Video Convert	Input signal				Monitor output (Normally)				Monitor output (when GUI menu displayed)			
	HDMI	COMPONENT	S-VIDEO	VIDEO	HDMI	COMPONENT	S-VIDEO	VIDEO	HDMI	COMPONENT	S-VIDEO	VIDEO
OFF	×	×	×	×	×	×	×	×	○	○	○	○
	×	×	×	○	×	×	×	○ (VIDEO)	○	○	○	○
	×	×	○	×	×	×	○ (S-VIDEO)	×	○	○	○	○
	×	×	○	○	×	×	○ (S-VIDEO)	○ (VIDEO)	○	○	○	○
	×	○	×	×	×	○ (COMPONENT)	×	×	○	○	○	○
	×	○	×	○	×	○ (COMPONENT)	×	○ (VIDEO)	○	○	○	○
	×	○	○	×	×	○ (COMPONENT)	○ (S-VIDEO)	×	○	○	○	○
	×	○	○	○	×	○ (COMPONENT)	○ (S-VIDEO)	○ (VIDEO)	○	○	○	○
	○	×	×	×	○ (HDMI)	×	×	×	○ (HDMI)*	×	×	×
	○	×	×	○	○ (HDMI)	×	×	○ (VIDEO)	○ (HDMI)*	×	×	×
	○	×	○	×	○ (HDMI)	×	○ (S-VIDEO)	×	○ (HDMI)*	×	×	×
	○	×	○	○	○ (HDMI)	×	○ (S-VIDEO)	○ (VIDEO)	○ (HDMI)*	×	×	×
	○	○	×	×	○ (HDMI)	○ (COMPONENT)	×	×	○ (HDMI)*	×	×	×
	○	○	×	○	○ (HDMI)	○ (COMPONENT)	×	○ (VIDEO)	○ (HDMI)*	×	×	×
	○	○	○	×	○ (HDMI)	○ (COMPONENT)	○ (S-VIDEO)	×	○ (HDMI)*	×	×	×
	○	○	○	○	○ (HDMI)	○ (COMPONENT)	○ (S-VIDEO)	○ (VIDEO)	○ (HDMI)*	×	×	×

○ : Signal present  
 × : No signal

○ : Output present  
 × : No output  
 \* : Superimposed over video signal



To display the GUI menu on an HDMI monitor, output with a resolution of 480p/576p.

**ZONE2**

Video Convert	Input signal			Monitor output		
	COMPONENT	S-VIDEO	VIDEO	COMPONENT	S-VIDEO	VIDEO
ON	×	×	×	×	×	×
	×	×	○	○ (VIDEO)	○ (VIDEO)	○ (VIDEO)
	×	○	×	○ (S-VIDEO)	○ (S-VIDEO)	○ (S-VIDEO)
	×	○	○	○ (S-VIDEO)	○ (S-VIDEO)	○ (S-VIDEO)
	○ (1080p)	×	×	○ (COMPONENT)	×	×
	○ (480p ~ 720p)	×	×	○ (COMPONENT)	×	×
	○ (480i / 576i)	×	×	○ (COMPONENT)	○ (COMPONENT)	○ (COMPONENT)
	○ (1080p)	×	○	○ (COMPONENT)*1	○ (VIDEO)	○ (VIDEO)
	○ (480p ~ 720p)	×	○	○ (COMPONENT)*1	○ (VIDEO)	○ (VIDEO)
	○ (480i / 576i)	×	○	○ (COMPONENT)*1	○ (COMPONENT)	○ (VIDEO)
	○ (1080p)	○	×	○ (COMPONENT)*2	○ (S-VIDEO)	○ (S-VIDEO)
	○ (480p ~ 720p)	○	×	○ (COMPONENT)*2	○ (S-VIDEO)	○ (S-VIDEO)
	○ (480i / 576i)	○	×	○ (COMPONENT)*2	○ (S-VIDEO)	○ (S-VIDEO)
	○ (1080p)	○	○	○ (COMPONENT)*2	○ (S-VIDEO)	○ (S-VIDEO)
	○ (480p ~ 720p)	○	○	○ (COMPONENT)*2	○ (S-VIDEO)	○ (S-VIDEO)
	○ (480i / 576i)	○	○	○ (COMPONENT)*2	○ (S-VIDEO)	○ (S-VIDEO)

○ : Output present  
 × : No output  
 \*1 : With On-screen display, the VIDEO signal is superimposed output.  
 \*2 : With On-screen display, the S-VIDEO signal is superimposed output.  
 COMPONENT :  
 When you operate the **MENU** button, on-screen display is displayed.

Video Convert	S-VIDEO Monitor Out	Input signal			Monitor output		
		COMPONENT	S-VIDEO	VIDEO	COMPONENT	S-VIDEO	VIDEO
OFF	-	×	×	×	×	×	×
	-	×	×	○	×	×	○ (VIDEO)
	-	×	○	×	×	○ (S-VIDEO)	×
	Used	×	○	○	×	○ (S-VIDEO)	○ (VIDEO)*2
	Not used	×	○	○	×	-	○ (VIDEO)
	-	○	×	×	○ (COMPONENT)	×	×
	-	○	×	○	○ (COMPONENT)*1	×	○ (VIDEO)
	-	○	○	×	○ (COMPONENT)*2	○ (S-VIDEO)	×
	Used	○	○	○	○ (COMPONENT)*2	○ (S-VIDEO)	○ (VIDEO)*2
Not used	○	○	○	○ (COMPONENT)*1	-	○ (VIDEO)	

○ : Output present  
 × : No output  
 \*1 : With On-screen display, the VIDEO signal is superimposed output.  
 \*2 : With On-screen display, the S-VIDEO signal is superimposed output.

□ ZONE3

Input signal		Monitor output
S-VIDEO	VIDEO	VIDEO
×	×	×
×	○	○ (VIDEO)
○	×	○ (S-VIDEO)
○	○	○ (S-VIDEO)
×	×	×
×	○	○ (VIDEO)
○	×	○ (S-VIDEO)
○	○	○ (S-VIDEO)

○ : Signal present  
 × : No signal  
 ○ : Output present  
 × : No output

# Troubleshooting

If a problem should arise, first check the following:

1. Are the connections correct?
2. Is the set being operated as described in the owner's manual?
3. Are the other components operating properly?

If this unit does not operate properly, check the items listed in the table below. Should the problem persist, there may be a malfunction.

In this case, disconnect the power immediately and contact your store of purchase.

## [General]

Symptom	Cause	Countermeasure	Page
Power does not turn on, or turns off directly after it was turned on.	<ul style="list-style-type: none"> <li>• Connection of the power cord is faulty.</li> </ul>	<ul style="list-style-type: none"> <li>• Check that the power plugs are securely inserted into the AVP-A1HD's AC inlet and the wall power outlet.</li> </ul>	22
No sound is produced from speakers.	<ul style="list-style-type: none"> <li>• The connection with the input devices or power amp is faulty.</li> <li>• Device you want to play and set input source do not match.</li> <li>• Master volume is turned too low.</li> <li>• Mute mode is set.</li> <li>• Headphones are connected.</li> <li>• No digital signals are being input.</li> </ul>	<ul style="list-style-type: none"> <li>• Check the connections.</li> </ul>	11
		<ul style="list-style-type: none"> <li>• Select an appropriate input source.</li> <li>• Adjust the master volume to an appropriate level.</li> <li>• Cancel the mute mode.</li> <li>• Disconnect the headphones.</li> <li>• Select an input source for which the digital input setting has been made.</li> </ul>	42 54 54 42 ~ 44
	<ul style="list-style-type: none"> <li>• The connectors to which the digital inputs are assigned and the settable input modes do not match.</li> </ul>	<ul style="list-style-type: none"> <li>• Set the input mode.</li> </ul>	45
Display is off.	<ul style="list-style-type: none"> <li>• The "Dimmer" setting is set to "OFF".</li> <li>• The PURE DIRECT mode is set.</li> </ul>	<ul style="list-style-type: none"> <li>• Set to something other than "OFF".</li> </ul>	41
		<ul style="list-style-type: none"> <li>• Set a surround mode other than the PURE DIRECT mode.</li> </ul>	48
"DOLBY DIGITAL" indicator does not appear on display.	<ul style="list-style-type: none"> <li>• DVD player's digital audio output setting is not proper.</li> </ul>	<ul style="list-style-type: none"> <li>• Check the DVD player's audio output setting. For details, read the DVD player's operating instructions.</li> </ul>	-

Symptom	Cause	Countermeasure	Page
Power turns off suddenly and power indicator flashes red.	<ul style="list-style-type: none"> <li>• Set is damaged.</li> </ul>	<ul style="list-style-type: none"> <li>• Turn off the power and contact a DENON service center.</li> </ul>	-

## [Remote Control Unit]

Symptom	Cause	Countermeasure	Page
Set does not work properly when remote control unit operated.	<ul style="list-style-type: none"> <li>• Batteries are worn.</li> <li>• You are operating outside of the specified range.</li> <li>• Obstacle between main unit and remote control unit.</li> <li>• The batteries are not inserted in the proper direction, as indicated by the polarity marks in the battery compartment.</li> <li>• The set's remote control sensor is exposed to strong light (direct sunlight, inverter type fluorescent bulb light, etc.).</li> <li>• The remote ID of the main unit and remote control unit do not match.</li> </ul>	<ul style="list-style-type: none"> <li>• Replace with new batteries.</li> <li>• Operate within the specified range.</li> <li>• Remove the obstacle.</li> <li>• Insert the batteries in the proper direction, following the polarity marks in the battery compartment.</li> <li>• Move the set to a place in which the remote control sensor will not be exposed to strong light.</li> <li>• Set the same remote IDs for the main unit and remote control unit.</li> </ul>	3, 4 4 - 3, 4 4 40, 69, 74



[Audio]

Symptom	Cause	Countermeasure	Page
No sound is produced from center speaker.	<ul style="list-style-type: none"> <li>You are playing a monaural source (TV, AM radio broadcast, etc.) in the "STANDARD" (Dolby/DTS Surround) or "HOME THX CINEMA" mode.</li> </ul>	<ul style="list-style-type: none"> <li>The mode is set to something other than "STANDARD" (Dolby/DTS Surround) or "HOME THX CINEMA" .</li> </ul>	46, 47
No sound is produced from surround speakers.	<ul style="list-style-type: none"> <li>The surround mode is set to "STEREO", "DIRECT" or "PURE DIRECT".</li> </ul>	<ul style="list-style-type: none"> <li>Set to a surround playback mode.</li> </ul>	46 ~ 48
No sound is produced from surround back speaker.	<ul style="list-style-type: none"> <li>Surround back speaker setting is set to "None".</li> <li>Surround mode not set to a mode for 6.1- or 7.1-channel playback.</li> </ul>	<ul style="list-style-type: none"> <li>Set to something other than "None".</li> <li>Select a surround playback mode.</li> </ul>	28 46 ~ 48
No sound is produced from subwoofer.	<ul style="list-style-type: none"> <li>Subwoofer's power not turned on.</li> <li>The "Subwoofer" setting at "Speaker configuration" is set to "No".</li> <li>The subwoofer is not properly connected.</li> <li>The subwoofer's volume is turned off.</li> </ul>	<ul style="list-style-type: none"> <li>Turn on the subwoofer's power.</li> <li>Set to "Yes".</li> <li>Check the connections.</li> <li>Adjust the subwoofer's volume to an appropriate level.</li> </ul>	- 28 11 -
No test tones are produced when main remote control unit's <b>TEST</b> button is pressed.	<ul style="list-style-type: none"> <li>Surround mode not set to "STANDARD" (Dolby/DTS Surround) or "HOME THX CINEMA" mode.</li> </ul>	<ul style="list-style-type: none"> <li>Set to the "STANDARD" (Dolby/DTS Surround) or "HOME THX CINEMA" mode.</li> </ul>	46, 47
DTS sound is not output.	<ul style="list-style-type: none"> <li>DVD player's audio output setting is not set to bitstream.</li> <li>DVD player is not compatible with DTS sound playback.</li> <li>The AVP-A1HD's "Decode Mode" setting is set to "PCM".</li> </ul>	<ul style="list-style-type: none"> <li>Set the DVD player. For details, refer to the DVD player's operating instructions.</li> <li>Use a DTS-compatible player.</li> <li>Set to the "Auto" or "DTS" mode.</li> </ul>	- - 45
HDMI audio signals are not output from speakers.	<ul style="list-style-type: none"> <li>The "Manual Setup" – "HDMI Setup" – "Audio" setting is set to "TV".</li> </ul>	<ul style="list-style-type: none"> <li>Set to "Amp".</li> </ul>	31

Symptom	Cause	Countermeasure	Page
No sound is output from the monitor connected with HDMI connections.	<ul style="list-style-type: none"> <li>The "Manual Setup" – "HDMI Setup" – "Audio" setting is set to "Amp".</li> </ul>	<ul style="list-style-type: none"> <li>Set to "TV".</li> </ul>	31

[Video]

Symptom	Cause	Countermeasure	Page
The on-screen display does not appear.	<ul style="list-style-type: none"> <li>The format of the GUI and TV (PAL or NTSC) do not match.</li> </ul>	<ul style="list-style-type: none"> <li>Match the format of the GUI and TV.</li> </ul>	39
No picture appears.	<ul style="list-style-type: none"> <li>The connections between the AVP-A1HD and monitor are faulty.</li> <li>The monitor's input setting is wrong.</li> <li>PURE DIRECT mode is set.</li> <li>The player is connected using the component input connectors, the monitor is connected using the video (yellow) or S-Video output connectors.</li> </ul>	<ul style="list-style-type: none"> <li>Check the connections.</li> <li>Set properly.</li> <li>Cancel the PURE DIRECT mode.</li> <li>High definition (1080i/720p) and progressive (480p/576p) video signals are not down-converted. Set the player to interlace (480i/576i) signals.</li> </ul>	12, 13 - 48 -
No picture appears with HDMI connections.	<ul style="list-style-type: none"> <li>The connections to the HDMI connectors are faulty.</li> <li>HDMI input setting is improper.</li> <li>The monitor is not compatible with copyright protection (HDCP).</li> <li>The HDMI format of the player and monitor do not match.</li> </ul>	<ul style="list-style-type: none"> <li>Check the connections.</li> <li>Check the HDMI input setting.</li> <li>Connect a monitor that is compatible with copyright protection (HDCP).</li> <li>Match the HDMI format of the player and monitor.</li> </ul>	12 43 12 12
Picture cannot be recorded.	<ul style="list-style-type: none"> <li>Input source does not match recorder's video connection connector (video or S-Video).</li> </ul>	<ul style="list-style-type: none"> <li>The video conversion function does not work for the REC OUT connectors. Match the input source and recorder connections.</li> </ul>	16, 17
DVDs cannot be copied on a VCR.	-	<ul style="list-style-type: none"> <li>This is not a malfunction. Most movie software includes copy prevention signals and cannot be copied.</li> </ul>	-

[iPod]

Symptom	Cause	Countermeasure	Page
iPod cannot be played.	<ul style="list-style-type: none"> <li>The input source assigned to "iPod dock" is not selected.</li> <li>Cable is not properly connected.</li> <li>Control Dock for iPod's AC adapter is not connected to power outlet.</li> </ul>	Switch to the input source assigned at "iPod dock".	44
		Reconnect.	14
		Plug the Control Dock for iPod's AC adapter into a power outlet.	-

[NET/USB]

Symptom	Cause	Countermeasure	Page
When a USB memory device is connected, "USB" is not displayed on the GUI menu.	<ul style="list-style-type: none"> <li>The set cannot recognize a USB memory device.</li> <li>A USB memory device not conforming to mass storage class or MTP standards is connected.</li> <li>The set port and the connected port do not match.</li> <li>A USB memory device that the set cannot recognize is connected.</li> <li>USB memory device is connected via USB hub.</li> </ul>	Check the connection.	19
		Connect a USB memory device conforming to mass storage class or MTP standards.	-
		Connect to the port set at "USB Select".	46
		This is not a malfunction. DENON does not guarantee that all USB memory devices will operate or receive power.	-
Files on a USB memory device cannot be played.	<ul style="list-style-type: none"> <li>USB memory device is in format other than FAT16 or FAT32.</li> <li>USB memory device is divided into multiple partitions.</li> <li>Files are stored in a non-compatible format.</li> <li>You are attempting to play a file that is copyright protected.</li> </ul>	Connect the USB memory device directly to the USB port.	-
		Set the format to FAT16 or FAT32. For details, refer to the USB memory device's operating instructions.	-
		When divided into multiple partitions, only files stored in the top partition can be played.	57
		Record the files in a compatible format.	57
The file names are not displayed properly (".." etc.).	<ul style="list-style-type: none"> <li>Characters that cannot be displayed are used.</li> </ul>	Files that are copyright protected cannot be played on this set.	-
		This is not a malfunction. On this set, characters that cannot be displayed are replaced with a ". (period)".	-

Symptom	Cause	Countermeasure	Page
Internet radio cannot be played.	<ul style="list-style-type: none"> <li>Ethernet cable is not properly connected or network is disconnected.</li> <li>Program is being broadcast in non-compatible format.</li> <li>The computer's or router's firewall is activated.</li> <li>Radio station is not currently broadcasting.</li> <li>IP address is wrong.</li> </ul>	Check the connection status.	20
		Only Internet radio programs in MP3 and WMA can be played on this set.	56, 57
		Check the computer's or router's firewall settings.	-
Files stored on a computer cannot be played.	<ul style="list-style-type: none"> <li>Files are stored in a non-compatible format.</li> <li>You are attempting to play a file that is copyright protected.</li> <li>Set and computer are connected by USB cable.</li> </ul>	Choose a radio station that is currently broadcasting.	59
		Check the set's IP address.	36
		Record in a compatible format.	56, 57
Server is not found, or it is not possible to connect to the server.	<ul style="list-style-type: none"> <li>The computer's or router's firewall is activated.</li> <li>Computer's power is not turned on.</li> <li>Server is not running.</li> <li>Set's IP address is wrong.</li> </ul>	Files that are copyright protected cannot be played on this set.	56, 57
		The set's USB port cannot be used for connection to a computer.	-
		Check the computer's or router's firewall settings.	-
Cannot connect to preset or favorite radio stations.	<ul style="list-style-type: none"> <li>Radio station is not currently broadcasting.</li> <li>Radio station is not currently in service.</li> </ul>	Turn on the power.	-
		Launch the server.	-
		Check the set's IP address.	36
For some radio stations, "Server Full" or "Connection Down" is displayed and station cannot be connected to.	<ul style="list-style-type: none"> <li>Station is congested or not currently broadcasting.</li> </ul>	Wait a while before trying again.	-
		It is not possible to connect to radio stations that are no longer in service.	-
Sound is broken during playback.	<ul style="list-style-type: none"> <li>Network's signal transfer speed is slow or communications lines or radio station is congested.</li> </ul>	Wait a while before trying again.	-
		This is not a malfunction. When playing broadcast data with a high bit rate, the sound may be broken, depending on the communications conditions.	-
Sound quality is poor or played sound is noisy.	<ul style="list-style-type: none"> <li>File being played has a low bit rate.</li> </ul>	This is not a malfunction.	-

**[Wireless LAN]**

Symptom	Cause	Countermeasure	Page
Cannot connect to network.	<ul style="list-style-type: none"> <li>The settings of the SSID and network key (WEP) are incorrect.</li> <li>The reception is poor and the signals cannot be received.</li> </ul>	<ul style="list-style-type: none"> <li>Match the network settings with the AVP-A1HD's settings.</li> </ul>	34, 35
		<ul style="list-style-type: none"> <li>Shorten the distance from the wireless LAN's access point, remove any obstacles and otherwise improve visibility, then try reconnecting. Also install away from microwave ovens and the access points of other networks.</li> </ul>	—
Played sound is interrupted or sound cannot be played.	<ul style="list-style-type: none"> <li>There are multiple networks and the usable channels overlap.</li> </ul>	<ul style="list-style-type: none"> <li>Set the access point's channel settings away from the channels used for other networks. Alternatively, connect using a network cable.</li> </ul>	—
		<ul style="list-style-type: none"> <li>Set the access point's channel settings away from the channels used for other networks. Alternatively, connect using a network cable.</li> </ul>	—

## Specifications

### □ Audio section

#### • Analog

**Input sensitivity / Input impedance:** RCA Pre output (unbalanced) : 200 mV / 47 kΩ/kohms  
XLR Pre output (balanced) : 400 mV / 100 kΩ/kohms

**Frequency response:** 10 Hz ~ 100 kHz +1, -3 dB (DIRECT mode)

**S/N:** 102 dB (IHF-A weighted, DIRECT mode)

**Distortion:** 0.005 % (20 Hz ~ 20 kHz) (DIRECT mode)

**Rated output:** RCA Pre output (unbalanced) : 1.2 V  
XLR Pre output (balanced) : 2.4 V

#### • Digital

**D/A output:** Rated output — 2 V (at 0 dB playback)  
Total harmonic distortion — 0.005 % (1 kHz, at 0 dB)  
Dynamic range — 110 dB  
Format — Digital audio interface

#### Digital input:

#### • Phono equalizer (PHONO input — REC OUT)

**Input sensitivity:** 2.5 mV

**RIAA deviation:** ±1 dB (20 Hz to 20 kHz)

**S/N:** 74 dB (A weighting, with 5 mV input)

**Rated output:** 150 mV

**Distortion factor:** 0.03 % (1 kHz, 3 V)

### □ Video section

#### • Standard video connectors

**Input / output level and impedance:** 1 Vp-p, 75 Ω/ohms

**Frequency response:** 5 Hz ~ 10 MHz — +0, -3 dB (when video convert set to "OFF")

#### • S-Video connectors

**Input / output level and impedance:** Y (brightness) signal — 1 Vp-p, 75 Ω/ohms  
C (color) signal — 0.3 (PAL) / 0.286 (NTSC) Vp-p, 75 Ω/ohms

**Frequency response:** 5 Hz ~ 10 MHz — +0, -3 dB (when video convert set to "OFF")

#### • Color component video connector

**Input / output level and impedance:** Y (brightness) signal — 1 Vp-p, 75 Ω/ohms  
P<sub>B</sub> / C<sub>B</sub> signal — 0.7 Vp-p, 75 Ω/ohms  
P<sub>R</sub> / C<sub>R</sub> signal — 0.7 Vp-p, 75 Ω/ohms

**Frequency response:** 5 Hz ~ 100 MHz — +0, -3 dB (when video convert set to "OFF")

## Wireless LAN

<b>Network type (wireless LAN standards) :</b>	Conforming to IEEE 802.11b Conforming to IEEE 802.11g (Conforming to Wi-Fi®)*
<b>Transfer rate:</b>	DS-SS: 11 / 5.5 / 2 / 1 Mbps (Automatic switching) OFDM: 54 / 48 / 36 / 24 / 18 / 12 / 9 / 6 Mbps (Automatic switching)
<b>Security:</b>	SSID (Network name) WEP key (network key) (64/128 bits) WPA-PSK (TKIP/AES) WPA2-PSK (TKIP/AES)
<b>Used frequency range:</b>	2,412 MHz ~ 2,472 MHz
<b>No. of channels:</b>	Conforming to IEEE 802.11b : 13ch (DS-SS) (Of which 1 channel used) Conforming to IEEE 802.11g : 13ch (OFDM) (Of which 1 channel used)

## General

<b>Power supply:</b>	AC 230 V, 50 Hz
<b>Power consumption:</b>	150 W 0.3 W (Standby)
<b>Maximum external dimensions:</b>	434 (W) x 214 (H) x 485 (D) mm
<b>Weight:</b>	27.5 kg

## Main remote control unit (RC-1067)

<b>Batteries:</b>	LR6/AA Type (two batteries)
<b>Maximum external dimensions:</b>	63 (W) x 238 (H) x 31 (D) mm
<b>Weight:</b>	190 g (including batteries)

## Sub remote control unit (RC-1070)

<b>Batteries:</b>	R03/AAA Type (two batteries)
<b>Maximum external dimensions:</b>	49 (W) x 220 (H) x 24.5 (D) mm
<b>Weight:</b>	114 g (including batteries)

\* : Wi-Fi® conformity indicates tested and proven interoperability by the "Wi-Fi Alliance," a group certifying interoperability among wireless LAN devices.

※ For purposes of improvement, specifications and design are subject to change without notice.

## Erste Schritte

### Zubehör

Überprüfen Sie, dass folgendes Zubehör im Lieferumfang des Produkts enthalten ist.

① Bedienungsanleitung.....	1
② CD-ROM (Bedienungsanleitung) .....	1
③ Kundendienstverzeichnis.....	1
④ Netzkabel (Kabellänge: Etwa 1,5 m).....	1
⑤ Haupt-Fernbedienung (RC-1067) .....	1
⑥ LR6/AA-Batterien (für RC-1067).....	2
⑦ Zusatz-Fernbedienung (RC-1070) .....	1
⑧ R03/AAA-Batterien (für RC-1070) .....	2
⑨ Stabantenne für Funk-LAN.....	1
⑩ Einmessmikrofon (Kabellänge: Etwa 7,6 m) .....	1

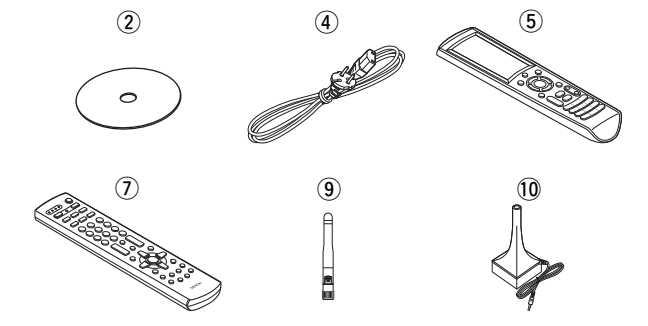

### Vorsichtshinweise zur Handhabung

#### • Vor dem Einschalten des Netzschalters

Vergewissern Sie sich noch einmal, dass alle Anschlüsse richtig sind und es keinerlei Probleme mit den Anschlusskabeln gibt.

- Es werden auch dann einige Schaltkreise mit Strom versorgt, wenn das Gerät in den Bereitschaftsmodus geschaltet wurde. Ziehen Sie den Stecker aus der Steckdose, wenn Sie verreisen oder die Wohnung für längere Zeit verlassen.

#### • Kondensation

Wenn zwischen der Temperatur im Inneren des Geräts und der Außentemperatur ein großer Unterschied besteht, kann es auf Bauteilen im Inneren des Geräts zu Kondensation (Taubildung) kommen, wodurch das Gerät nicht ordnungsgemäß funktioniert.

Lassen Sie das Gerät in diesem Fall ein bis zwei Stunden ausgeschaltet stehen und warten Sie, bis sich der Temperaturunterschied ausgeglichen hat, bevor Sie das Gerät benutzen.

#### • Vorsichtshinweise für die Verwendung von Mobiltelefonen

Die Verwendung eines Mobiltelefons in der Nähe dieses Gerätes kann zu Störungen führen. Sollte dies der Fall sein, verwenden Sie das Mobiltelefon bitte in sicherer Entfernung vom Gerät.

#### • Transport des Gerätes

Schalten Sie die Stromversorgung aus und ziehen Sie das Netzkabel aus der Netzsteckdose.

Ziehen Sie dann die Anschlusskabel anderer Systemgeräte ab, bevor Sie das Gerät transportieren.

- Beachten Sie bitte, dass die Abbildungen in dieser Betriebsanleitung vom tatsächlichen Gerätemodell abweichen können.
- Im AVP-A1HD-Stromkreis werden Leuchtdioden (LED) verwendet. Beim Einschalten des Stroms leuchtet im Innern des AVP-A1HD-Verstärkers ein grünes Licht auf; dies ist jedoch kein Fehler.

### Vorsichtshinweise zur Aufstellung

#### Hinweis:

Stellen Sie das Gerät nicht an einem geschlossenen Ort, wie in einem Bücherregal oder einer ähnlichen Einrichtung auf, da dies eine ausreichende Belüftung des Geräts behindern könnte.

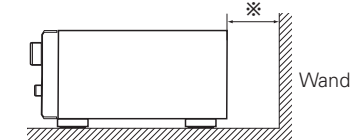
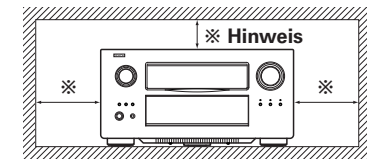

Bezeichnung und Funktionen der Teile

Vorderseite

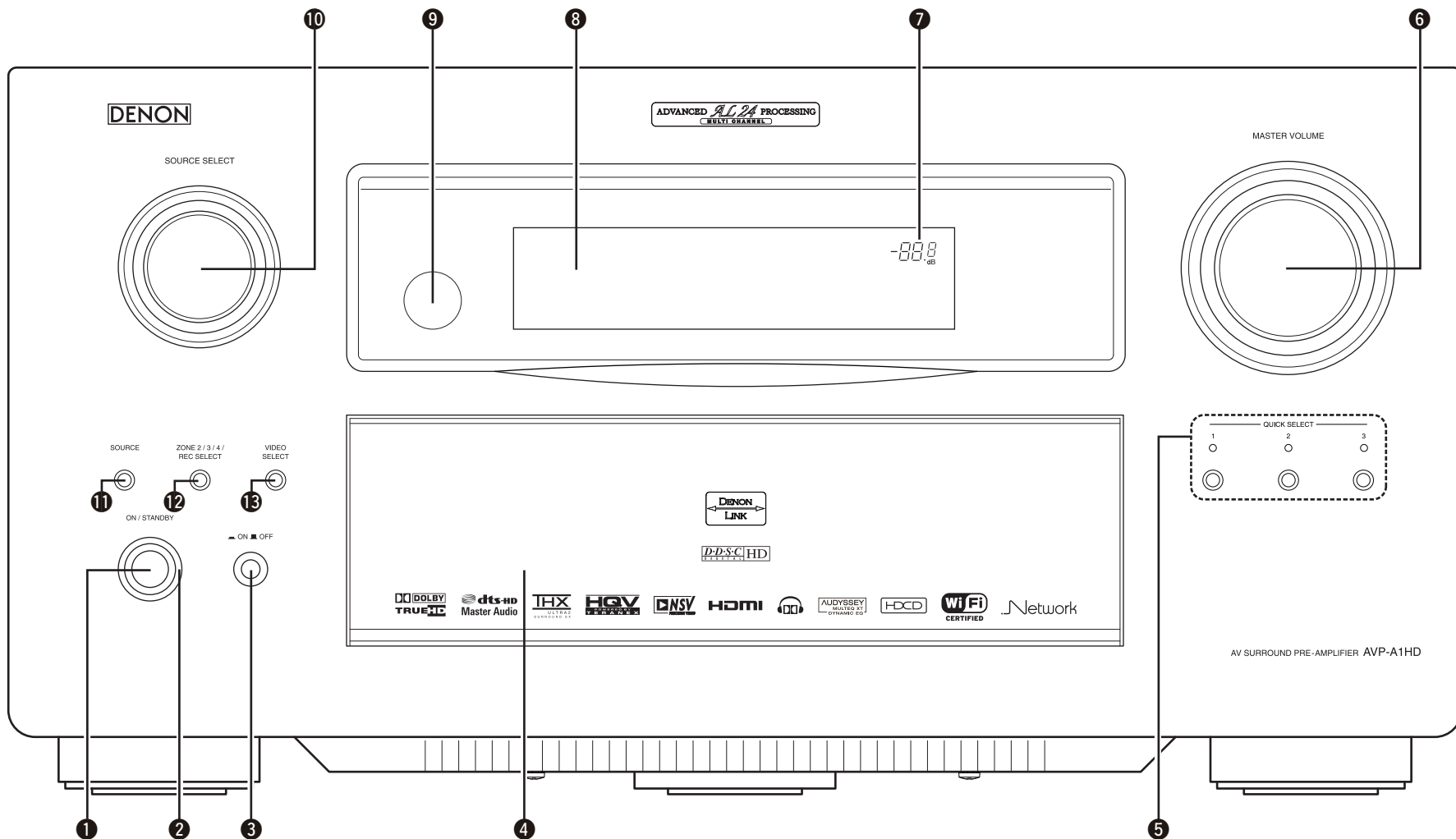

❶ Netzschalter (ON/STANDBY)

❷ Netzanzeige

❸ Geräteschalter (ON OFF)

❹ Klappe

❺ Tasten / Anzeigen QUICK SELECT

❻ MASTER VOLUME-Knopf

❼ Hauptlautstärkeanzeige

❽ Display

❾ Fernbedienungssensor

❿ SOURCE SELECT-Knopf

⓫ SOURCE-Taste

⓬ ZONE 2/3/4 / REC SELECT-Taste

⓭ VIDEO SELECT-Taste

[Mit offener Klappe]

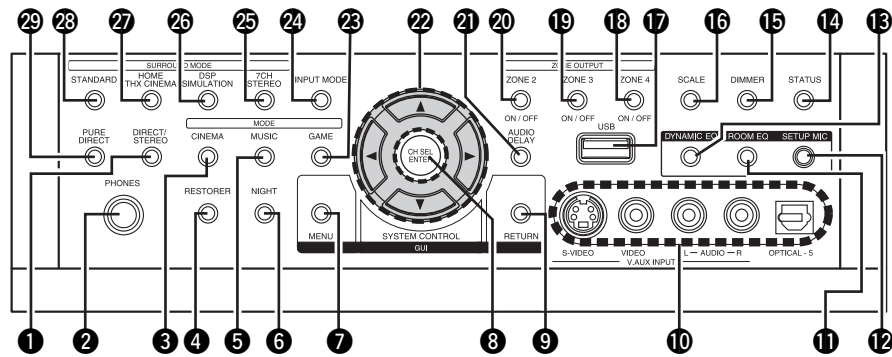

- 1 DIRECT/STEREO-Taste
- 2 Kopfhörerbuchse (PHONES)
- 3 CINEMA-Taste
- 4 RESTORER-Taste
- 5 MUSIC-Taste
- 6 NIGHT-Taste
- 7 MENU-Taste
- 8 CH SEL / ENTER-Taste
- 9 RETURN-Taste
- 10 V.AUX INPUT-Anschlüsse
- 11 ROOM EQ-Taste
- 12 SETUP MIC-Buchse
- 13 DYNAMIC EQ-Taste
- 14 STATUS-Taste
- 15 DIMMER-Taste
- 16 SCALE-Taste
- 17 USB-Anschluss
- 18 ZONE4 ON/OFF-Taste
- 19 ZONE3 ON/OFF-Taste
- 20 ZONE2 ON/OFF-Taste
- 21 AUDIO DELAY-Taste
- 22 Pfeiltaste (△▽◀▶)
- 23 GAME-Taste
- 24 INPUT MODE-Taste
- 25 7CH STEREO-Taste
- 26 DSP SIMULATION-Taste
- 27 HOME THX CINEMA-Taste
- 28 STANDARD-Taste
- 29 PURE DIRECT-Taste

Display

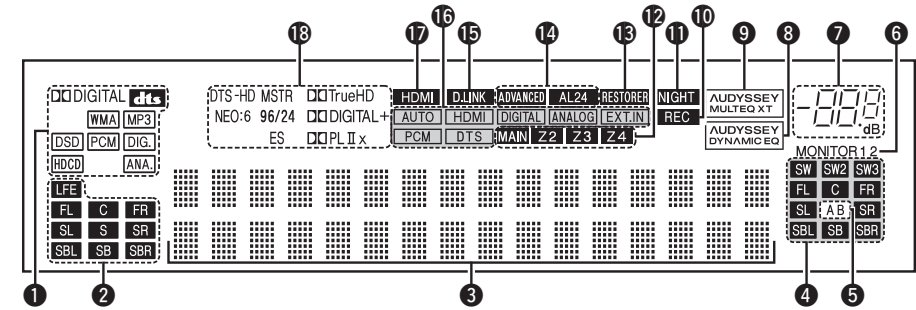

- 1 Anzeigen für das Eingangssignal
- 2 Anzeigen für den Kanal des Eingangssignals
- 3 Informationsdisplay
- 4 Anzeigen für den Kanal des Ausgangssignals
- 5 Surround-Lautsprecher-Anzeigen
- 6 Monitorausgabeanzeigen
- 7 Hauptlautstärkeanzeige
- 8 Anzeige AUDYSSEY DYNAMIC EQ
- 9 Anzeige AUDYSSEY MULTEQ XT
- 10 Anzeige für die Aufnahmeausgabequelle
- 11 NIGHT-Anzeige
- 12 Multi-Zone-Anzeigen
- 13 RESTORER-Anzeige
- 14 Anzeige ADVANCED AL24
- 15 Anzeige D.LINK
- 16 Eingangsmodusanzeigen
- 17 HDMI-Anzeige
- 18 Decoder-Anzeigen

Rückseite

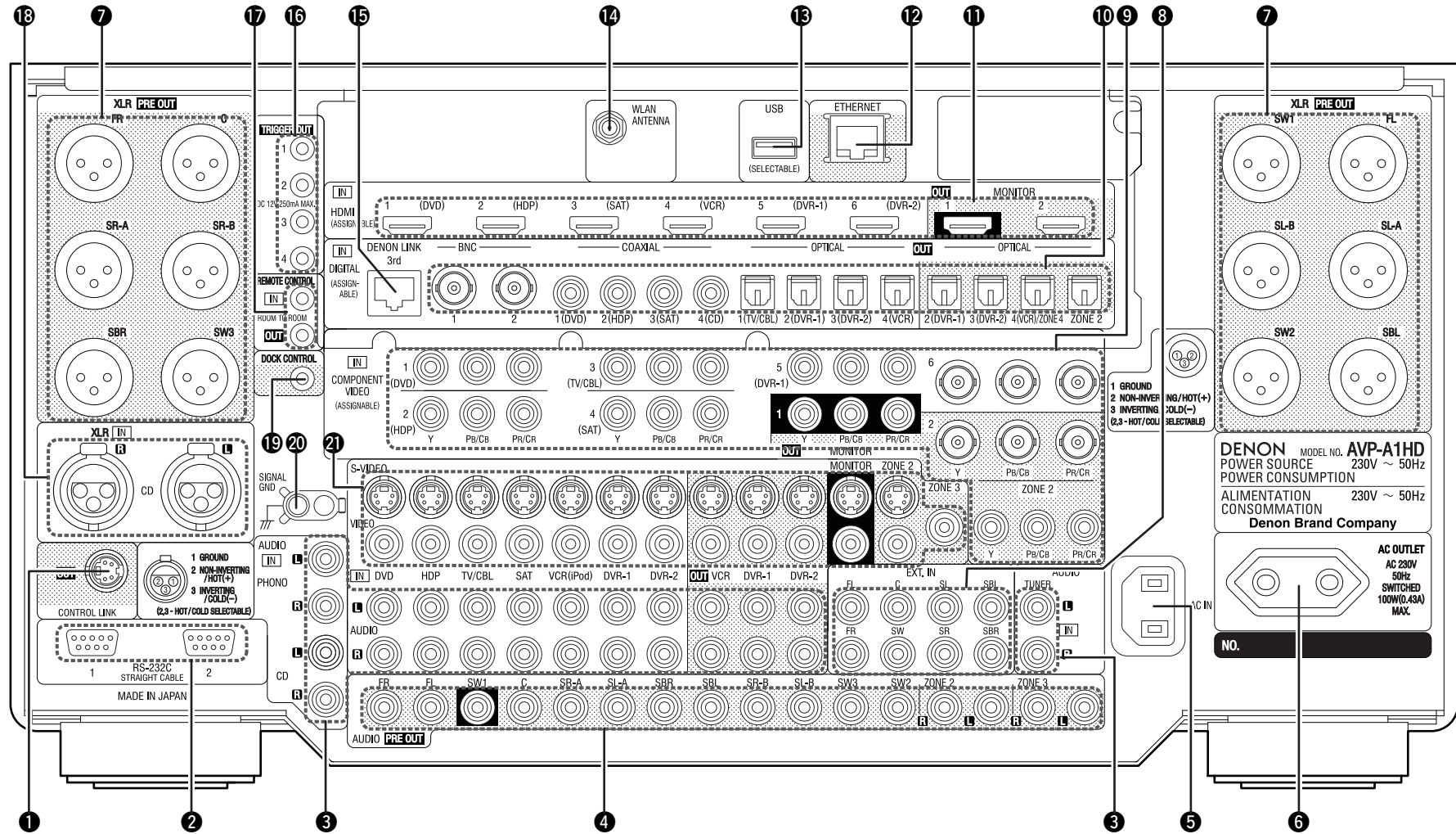

- 1 CONTROL LINK-Anschlüsse
- 2 RS-232C-Anschlüsse
- 3 Analoge Audioanschlüsse (AUDIO)
- 4 RCA PRE-Anschlüsse
- 5 AC-Eingang (AC IN)
- 6 Wechselstromausgang (AC OUTLET)

- 7 XLR PREOUT-Anschlüsse
- 8 EXT. IN-Anschlüsse
- 9 COMPONENT VIDEO-Anschlüsse
- 10 Digitale Audioanschlüsse (OPTICAL / COAXIAL / BNC)
- 11 HDMI-Anschlüsse

- 12 ETHERNET-Anschluss
- 13 USB-Anschluss
- 14 WLAN ANTENNA-Anschluss
- 15 DENON LINK-Anschluss
- 16 TRIGGER OUT-Buchsen
- 17 REMOTE CONTROL-Buchsen

- 18 XLR-Audiostecker (CD)
- 19 DOCK CONTROL-Buchse
- 20 SIGNAL GND-Anschluss
- 21 VIDEO / S-VIDEO-Anschlüsse



# Technische Daten

## Audiobereich

### • Analog

<b>Eingangsempfindlichkeit / Eingangsimpedanz:</b>	RCA-Pre-Output (nicht ausgeglichen) : 200 mV / 47 k $\Omega$ /kohm XLR-Pre-Output (ausgeglichen) : 400 mV / 100 k $\Omega$ /kohm
<b>Frequenzgang:</b>	10 Hz ~ 100 kHz — +1, -3 dB (DIRECT-Modus)
<b>Störabstand:</b>	102 dB (IHFA-bewertet, DIRECT-Modus)
<b>Klirrfaktor:</b>	0,005 % (20 Hz ~ 20 kHz), (DIRECT-Modus)
<b>Nennausgang:</b>	RCA-Pre-Output (nicht ausgeglichen) : 1,2 V XLR-Pre-Output (ausgeglichen) : 2,4 V

### • Digital

<b>D/A-Ausgang:</b>	Nennleistung — 2 V (bei 0 dB Wiedergabe) Harmonische Gesamtverzerrung (THD) — 0,005 % (1 kHz, bei 0 dB) Dynamikbereich — 110 dB
<b>Digitale Eingang:</b>	Format — Digitale Audioschnittstelle

### • Phono-Equalizer (PHONO-Eingang — REC OUT)

<b>Eingangsempfindlichkeit:</b>	2,5 mV
<b>RIAA-Abweichung:</b>	$\pm$ 1 dB (20 Hz bis 20 kHz)
<b>Störabstand:</b>	74 dB (A-Bewertung mit 5 mV Eingang)
<b>Nennausgang:</b>	150 mV
<b>Klirrfaktor:</b>	0,03 % (1 kHz, 3 V)

## Video

### • Standardvideoanschlüsse

<b>Eingangs- / Ausgangspegel und Impedanz:</b>	1 Vp-p, 75 $\Omega$ /Ohm
<b>Frequenzgang:</b>	5 Hz ~ 10 MHz — +0, -3 dB (wenn Videoumwandlung deaktiviert ist)

### • S-Video-Anschlüsse

<b>Eingangs- / Ausgangspegel und Impedanz:</b>	Y-Signal (Helligkeit) — 1 Vp-p, 75 $\Omega$ /Ohm C-Signal (Farbe) — 0,3 (PAL) / 0,286 (NTSC) Vp-p, 75 $\Omega$ /Ohm
<b>Frequenzgang:</b>	5 Hz ~ 10 MHz — +0, -3 dB (wenn Videoumwandlung deaktiviert ist)

### • Farbkomponenten-Videoanschluss

<b>Eingangs- / Ausgangspegel und Impedanz:</b>	Y-Signal (Helligkeit) — 1 Vp-p, 75 $\Omega$ /Ohm Pe- / Cb-Signal — 0,7 Vp-p, 75 $\Omega$ /Ohm Pr- / Cr-Signal — 0,7 Vp-p, 75 $\Omega$ /Ohm
<b>Frequenzgang:</b>	5 Hz ~ 10 MHz — +0, -3 dB (wenn Videoumwandlung deaktiviert ist)

## Funk-LAN

<b>Netzwerkart (Funk-LAN-Standards):</b>	IEEE 802.11b-konform IEEE 802.11g-konform (Wi-Fi <sup>®</sup> -konform)*
<b>Übertragungsrate:</b>	DS-SS: 11 / 5,5 / 2 / 1 MBit/s (Automatisches Switching) OFDM: 54 / 48 / 36 / 24 / 18 / 12 / 9 / 6 MBit/s (Automatisches Switching)
<b>Sicherheit:</b>	SSID (Netzwerkname) WEP-Schlüssel (Netzwerkschlüssel) (64/128 Bit) WPA-PSK (TKIP/AES) WPA2-PSK (TKIP/AES)
<b>Verwendeter Frequenzbereich:</b>	2,412 MHz ~ 2,472 MHz
<b>Kanalanzahl:</b>	IEEE 802.11b-konform: 13 Kanäle (DS-SS) (davon 1 Kanal verwendet) IEEE 802.11g-konform: 13 Kanäle (OFDM) (davon 1 Kanal verwendet)

## Allgemein

<b>Netzteil:</b>	230 V Wechselstrom, 50 Hz
<b>Leistungsverbrauch:</b>	150 W 0,3 W (Bereitschaft)
<b>Max. äußere Abmessungen:</b>	434 (B) x 214 (H) x 485 (T) mm
<b>Gewicht:</b>	275 kg

## Haupt-Fernbedienung (RC-1067)

<b>Batterien:</b>	LR6/AA-Typ (zwei Batterien)
<b>Max. äußere Abmessungen:</b>	63 (B) x 238 (H) x 31 (T) mm
<b>Gewicht:</b>	190 g (mit Batterien)

## Zusatz-Fernbedienung (RC-1070)

<b>Batterien:</b>	Typ R03/AAA (zwei Batterien)
<b>Max. äußere Abmessungen:</b>	49 (B) x 220 (H) x 24,5 (T) mm
<b>Gewicht:</b>	114 g (mit Batterien)

\*: Die Wi-Fi<sup>®</sup>-Konformität kennzeichnet die von der Wi-Fi Alliance, einer Gruppe, die die Interoperabilität für Funk-LAN-Geräte zertifiziert, getestete und nachgewiesene Interoperabilität.

※ Änderung der technischen Angaben und des Designs zum Zwecke der Verbesserung ohne Ankündigung vorbehalten.

# Introduction

## Accessoires

Assurez-vous que les articles suivants sont fournis avec l'appareil.

① Manuel de l'Utilisateur .....	1
② CD-ROM (Manuel de l'Utilisateur).....	1
③ Liste des services après-vente .....	1
④ Cordon d'alimentation (longueur du cordon: environ 1,5 m) .....	1
⑤ Télécommande principale (RC-1067) .....	1
⑥ Piles LR6/AA (pour RC-1067).....	2
⑦ Télécommande secondaire (RC-1070) .....	1
⑧ Pile R03/AAA (pour RC-1070) .....	2
⑨ Antenne en tige pour connexion au réseau local sans fil (WLAN).....	1
⑩ Microphone de configuration (longueur du cordon: environ 7,6 m) .....	1

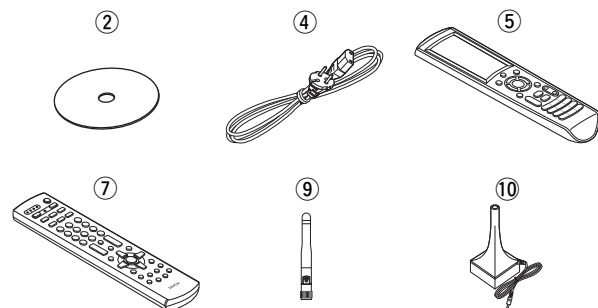

## Précautions de manipulation

- **Avant de mettre l'appareil sous tension**  
Vérifiez que toutes les connexions ont été correctement effectuées et que les câbles sont fonctionnels.
- Certains circuits restent sous tension même lorsque l'appareil est mis en mode veille. En cas d'absence prolongée, débranchez le cordon d'alimentation de la prise murale.
- **A propos de la condensation**  
Si la différence de température entre l'intérieur de l'unité et la pièce est importante, de la condensation (buée) risque de se former sur les pièces internes, empêchant l'unité de fonctionner correctement.  
Dans ce cas, laissez l'unité hors tension au repos pendant une heure ou deux, jusqu'à ce que la différence de température diminue.
- **Précautions liées à l'utilisation des téléphones portables**  
L'utilisation d'un téléphone portable à proximité de cette unité risque de causer du bruit. Dans ce cas, éloignez le téléphone portable de l'unité lorsque celle-ci est en marche.
- **Déplacement de l'unité**  
Eteignez l'unité et débranchez le cordon d'alimentation de la prise murale.  
Débranchez ensuite les câbles de connexion aux autres composants du système avant de déplacer l'unité.
- Veuillez remarquer que les illustrations de ce manuel sont données à titre explicatif et peuvent différer par rapport à l'unité.
- Les diodes électroluminescentes (LED) sont dans le circuit AVP-A1HD. Une fois l'appareil activé, un témoin vert s'allume dans le AVP-A1HD. Il ne s'agit pas d'une anomalie.

## Précautions d'installation

**Remarque:**  
Pour permettre la dissipation de chaleur requise, n'installez pas cette unité dans un espace confiné tel qu'une bibliothèque ou un endroit similaire.

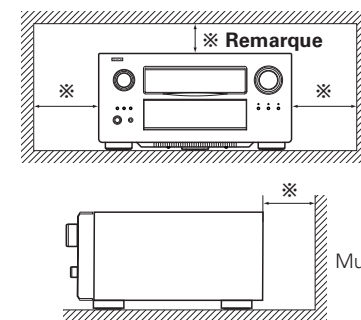

## Nomenclature et fonctions

## Panneau avant

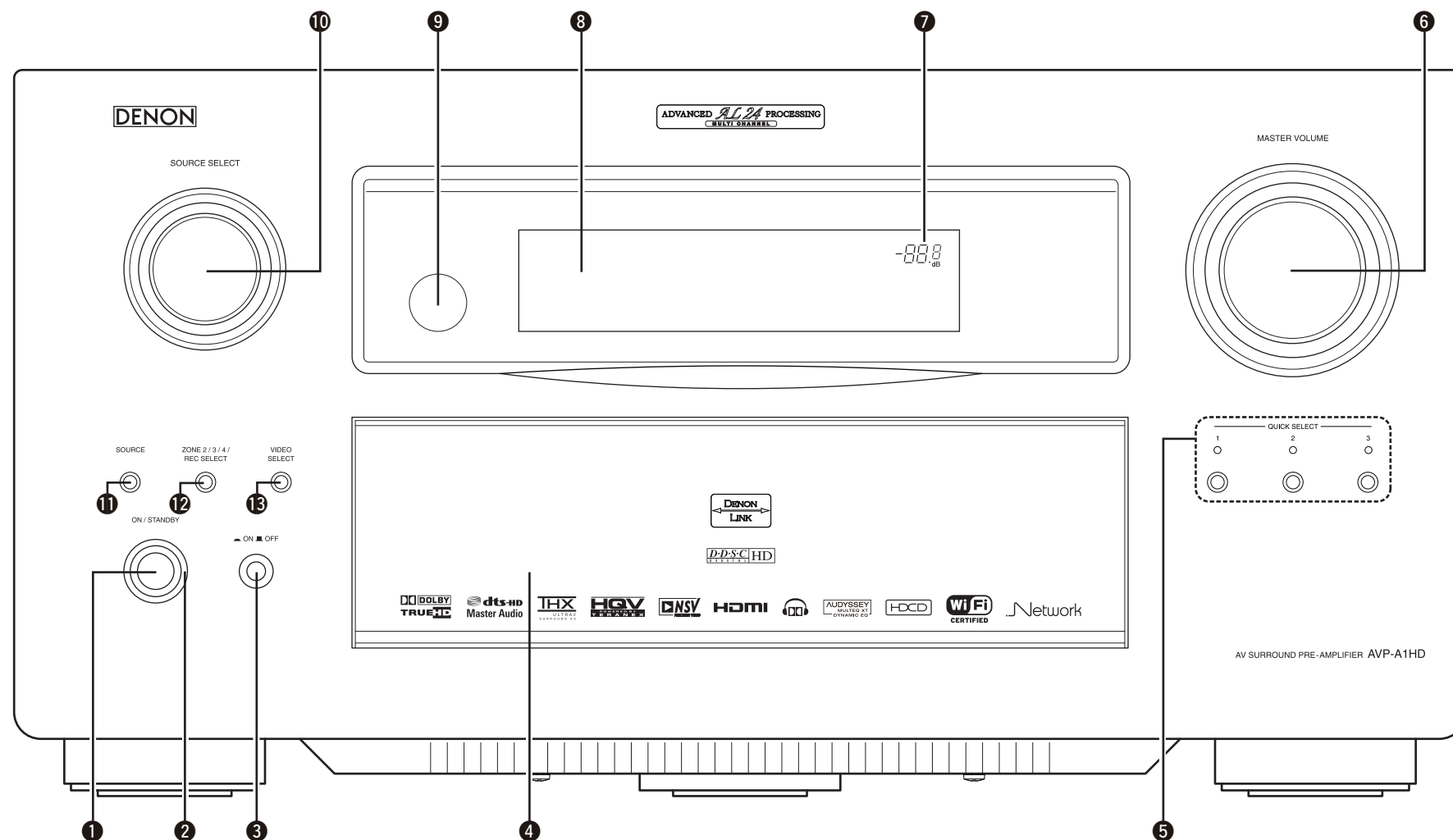

- ❶ Touche d'alimentation (ON/STANDBY)
- ❷ Témoin d'alimentation
- ❸ Interrupteur principal (ON OFF)
- ❹ Porte
- ❺ Touches / témoins QUICK SELECT

- ❻ Molette de contrôle MASTER VOLUME
- ❼ Témoin de volume principal
- ❽ Affichage
- ❾ Capteur de télécommande

- ❿ Molette SOURCE SELECT
- ⓫ Touche SOURCE
- ⓬ Touche ZONE 2/3/4 / REC SELECT
- ⓭ Touche VIDEO SELECT

## [Façade ouverte]

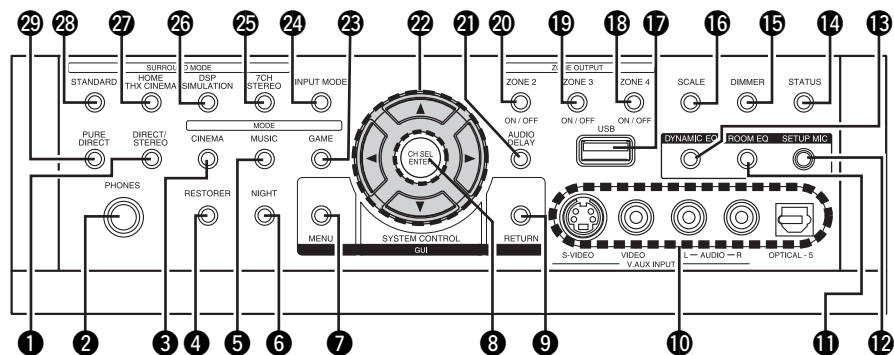

- 1 Touche DIRECT/STEREO
- 2 Prise de casque audio (PHONES)
- 3 Touche CINEMA
- 4 Touche RESTORER
- 5 Touche MUSIC
- 6 Touche NIGHT
- 7 Touche MENU
- 8 Touche CH SEL / ENTER
- 9 Touche RETURN
- 10 Bornes V.AUX INPUT
- 11 Touche ROOM EQ
- 12 Prise SETUP MIC
- 13 Touche DYNAMIC EQ
- 14 Touche STATUS
- 15 Touche DIMMER
- 16 Touche SCALE
- 17 Port USB
- 18 Touche ZONE4 ON/OFF
- 19 Touche ZONE3 ON/OFF
- 20 Touche ZONE2 ON/OFF
- 21 Touche AUDIO DELAY
- 22 Touches curseurs (Δ ▽ ◀ ▶)
- 23 Touche GAME
- 24 Touche INPUT MODE
- 25 Touche 7CH STEREO
- 26 Touche DSP SIMULATION
- 27 Touche HOMETHX CINEMA
- 28 Touche STANDARD
- 29 Touche PURE DIRECT

## Affichage

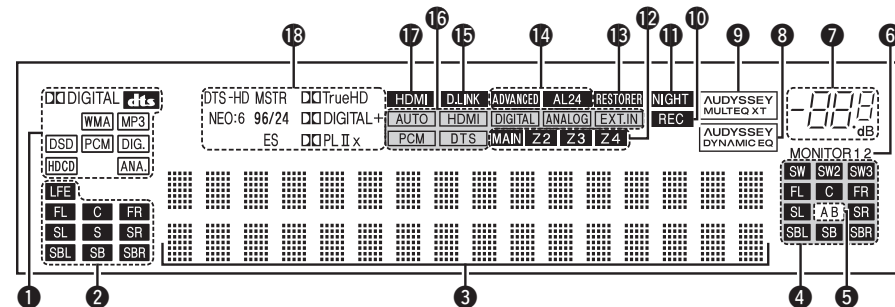

- 1 Témoins de signal d'entrée
- 2 Témoins de canal d'entrée  
S'allument lors de l'entrée de signaux numériques.
- 3 Affichage des informations  
Le nom de la source d'entrée, le mode surround, les valeurs des réglages et d'autres informations sont affichés ici.
- 4 Témoins de canal du signal de sortie
- 5 Témoins d'enceintes surround  
S'allument en fonction des réglages des enceintes surround A et B.
- 6 Témoins de sortie moniteur  
S'allument en fonction du réglage de la sortie moniteur HDMI. Si le réglage est sur "Auto (Dual)", les témoins s'allument en fonction de l'état de la connexion.
- 7 Témoin de volume principal
- 8 Témoin AUDYSSEY DYNAMIC EQ  
S'allume lorsque le Dynamic EQ a été sélectionné.
- 9 Témoin AUDYSSEY MULTEQ XT  
S'allume lorsque l'égaliseur de pièce a été sélectionné.
- 10 Témoin de source de sortie d'enregistrement  
S'allume lorsque le mode REC OUT a été sélectionné.
- 11 Témoin NIGHT  
S'allume lorsque le mode de nuit a été sélectionné.
- 12 Témoins multi-zone  
S'allument lorsque l'alimentation de la zone concernée a été activée.
- 13 Témoin RESTORER  
S'allume lorsque le mode RESTORER a été sélectionné.
- 14 Témoin ADVANCED AL24  
S'allume lorsque Advanced AL24 Processing a été activé.
- 15 Témoin D.LINK  
S'allume lorsque la reproduction se fait par l'intermédiaire des connexions DENON LINK.
- 16 Témoin en mode d'entrée
- 17 Témoin HDMI  
S'allume lorsque la reproduction se fait par l'intermédiaire des connexions HDMI.
- 18 Témoins de décodeur  
S'allument lorsque les décodeurs respectifs fonctionnent.

## Panneau arrière

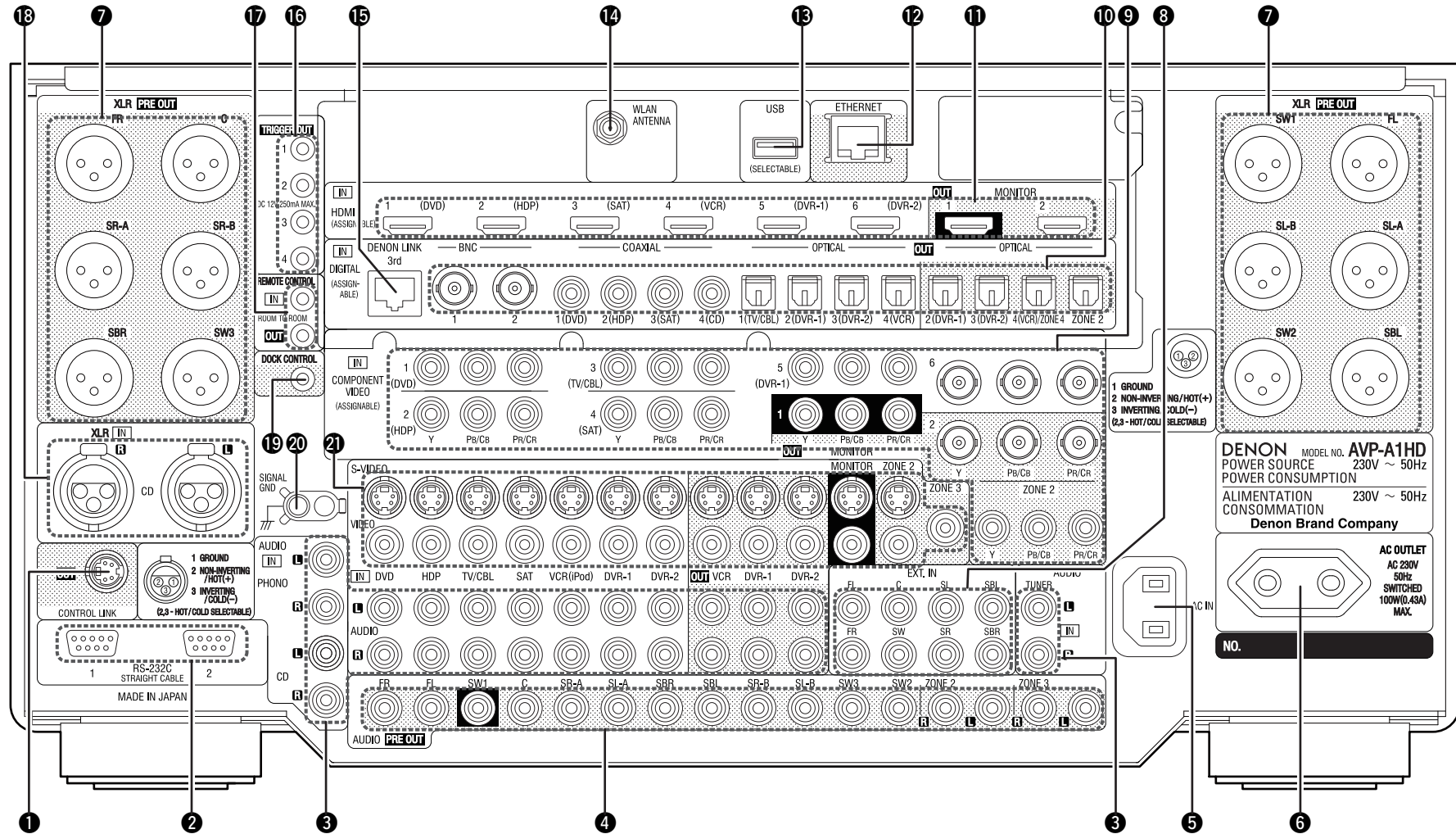

❶ Borne CONTROL LINK

❷ Borne RS-232C

❸ Bornes audio analogiques (AUDIO)

❹ Bornes RCA PRE OUT

❺ Prise CA (AC IN)

❻ Sortie CA (AC OUTLET)

❷ Bornes XLR PREOUT

❸ Bornes EXT. IN

❹ Bornes COMPONENT VIDEO

❺ Bornes audio numériques  
(OPTICAL / COAXIAL / BNC)

❻ Bornes HDMI

❷ Borne ETHERNET

❸ Port USB

❹ Borne WLAN ANTENNA

❺ Borne DENON LINK

❻ Prises TRIGGER OUT

❼ Prises REMOTE CONTROL

❷ Bornes XLR audio (CD)

❸ Prise DOCK CONTROL

❹ Borne SIGNAL GND terminal

❺ Bornes VIDEO / S-VIDEO

# Spécifications

## Section audio

### Analogique

**Sensibilité d'entrée / Impédance d'entrée:** Pré-sortie RCA (non balancé) : 200 mV / 47 kΩ/kohms  
Pré-sortie XLR (balancé) : 400 mV / 100 kΩ/kohms

**Réponse en fréquence:** 10 Hz ~ 100 kHz — +1, -3 dB (mode DIRECT)

**S/B:** 102 dB (IHF-A chargée, mode DIRECT)

**Distorsion:** 0,005 % (20 Hz ~ 20 kHz, mode DIRECT)

**Puissance nominale:** Pré-sortie RCA (non balancé) : 1,2 V  
Pré-sortie XLR (balancé) : 2,4 V

### Numérique

**Sortie N/A:** Sortie nominale — 2 V (en lecture à 0 dB)  
Distorsion harmonique totale — 0,005 % (1 kHz, à 0 dB)  
Gamme dynamique — 110 dB

**Entrée numérique:** Format — Interface audio numérique

### Egaliseur phono (entrée PHONO — REC OUT)

**Sensibilité de l'entrée:** 2,5 mV

**Variation RIAA:** ±1 dB (20 Hz à 20 kHz)

**S/B:** 74 dB (pondéré, avec entrée de 5 mV)

**Puissance nominale:** 150 mV

**Facteur de distorsion:** 0,03 % (1 kHz, 3 V)

## Section vidéo

### Bornes vidéo standard

**Niveau d'entrée / sortie et impédance:** 1 Vp-p, 75 Ω/ohms

**Réponse en fréquence:** 5 Hz ~ 10 MHz — +0, -3 dB (conversion vidéo réglée sur "ARRÊT")

### Bornes S-Vidéo

**Niveau d'entrée / sortie et impédance:** Signal Y (luminosité) — 1 Vp-p, 75 Ω/ohms  
Signal C (couleur) — 0,3 (PAL) / 0,286 (NTSC) Vp-p, 75 Ω/ohms

**Réponse en fréquence:** 5 Hz ~ 10 MHz — +0, -3 dB (conversion vidéo réglée sur "ARRÊT")

### Borne vidéo composante couleur

**Niveau d'entrée / sortie et impédance:** Signal Y (luminosité) — 1 Vp-p, 75 Ω/ohms  
Signal P<sub>B</sub> / C<sub>B</sub> — 0,7 Vp-p, 75 Ω/ohms  
Signal P<sub>R</sub> / C<sub>R</sub> — 0,7 Vp-p, 75 Ω/ohms

**Réponse en fréquence:** 5 Hz ~ 100 MHz — +0, -3 dB (conversion vidéo réglée sur "ARRÊT")

## LAN sans fil

### Type de réseau

#### (standards de LAN sans fil):

Conforme IEEE 802.11b  
Conforme IEEE 802.11g  
(Conforme Wi-Fi®)\*

### Taux de transfert:

DS-SS: 11 / 5,5 / 2 / 1 Mbps (Commutation automatique)  
OFDM: 54 / 48 / 36 / 24 / 18 / 12 / 9 / 6 Mbps (Commutation automatique)

### Sécurité:

SSID (Nom de réseau)  
Clé WEP (clé de réseau) (64/128 bits)  
WPA-PSK (TKIP/AES)  
WPA2-PSK (TKIP/AES)

### Bande de fréquences utilisée:

#### No. de canaux:

2,412 MHz ~ 2,472 MHz  
Conforme IEEE 802.11b: 13 canaux (DS-SS) (1 canal utilisé)  
Conforme IEEE 802.11g: 13 canaux (OFDM) (1 canal utilisé)

## Généralités

### Alimentation:

CA 230 V, 50 Hz

### Consommation:

150 W  
0,3 W (veille)

### Dimensions externes maximales:

434 (L) x 214 (H) x 485 (P) mm

### Poids:

27,5 kg

## Télécommande principale (RC-1067)

### Piles:

LR6/AA (deux piles)

### Dimensions externes maximales:

63 (L) x 238 (H) x 31 (P) mm

### Poids:

190 g (piles incluses)

## Télécommande secondaire (RC-1070)

### Piles:

R03/AAA (deux piles)

### Dimensions externes maximales:

49 (L) x 220 (H) x 24,5 (P) mm

### Poids:

114 g (piles incluses)

\*: La conformité Wi-Fi® indique l'interopérabilité testée et approuvée par l'Alliance Wi-Fi, un groupe de certification de l'interopérabilité entre les appareils LAN sans fil.

※ Pour des raisons d'amélioration, les caractéristiques et l'apparence sont susceptibles d'être modifiées sans avertissement préalable.

## Guida introduttiva

### Accessori

Verificare che le seguenti parti siano in dotazione con il prodotto.

①	Manuale delle istruzioni.....	1
②	CD-ROM (Manuale delle istruzioni).....	1
③	Elenco dei centri di assistenza tecnica.....	1
④	Cavo di alimentazione (lunghezza cavo: Circa 1,5 m).....	1
⑤	Telecomando principale (RC-1067).....	1
⑥	Batterie LR6/AA (per RC-1067).....	2
⑦	Telecomando secondario (RC-1070).....	1
⑧	Batterie R03/AAA (per RC-1070).....	2
⑨	Antenna a bacchetta per reti LAN wireless.....	1
⑩	Microfono di configurazione (lunghezza cavo: Circa 7,6 m).....	1

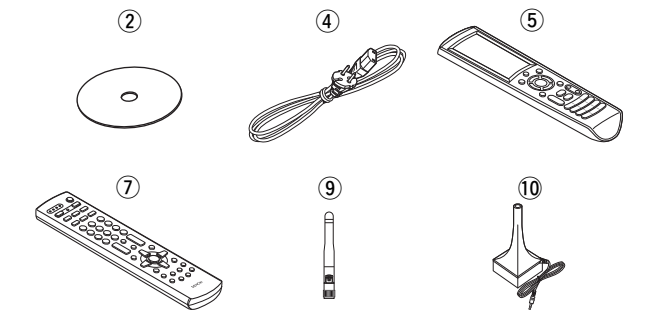

### Precauzioni per l'uso

#### • Prima di premere l'interruttore di accensione

Controllare nuovamente che tutti i collegamenti siano corretti e che non ci siano dei problemi con i cavi di collegamento.

- Anche quando l'unità viene impostata in modo standby, alcuni dei circuiti continuano a ricevere alimentazione. In previsione di un viaggio oppure di un'assenza prolungata, assicurarsi di scollegare il cavo di alimentazione della presa.

#### • Informazioni sulla condensa

Se la temperatura interna dell'unità differisce sensibilmente da quella nelle sue immediate vicinanze, può formarsi della condensa sulle parti operative all'interno dell'unità, causando dei malfunzionamenti nella stessa.

In tal caso, lasciar riposare l'unità per circa una-due ore con alimentazione spenta ed attendere una riduzione nella differenza di temperatura prima di utilizzare l'unità.

#### • Avvertenze sull'utilizzo di telefoni cellulari

L'utilizzo di un telefono cellulare vicino all'unità può provocare rumore. In tal caso, allontanare il telefono cellulare dall'unità quando questa è in uso.

#### • Spostamento dell'unità

Spegnere l'alimentazione e scollegare il cavo di alimentazione dalla presa di corrente.

Scollegare poi i cavi di connessione da altre unità di sistema prima di spostare l'unità.

- Osservare che, per fini esplicativi, le illustrazioni contenute nelle presenti istruzioni possono differire da quelle dell'unità effettiva.
- Il circuito dell'unità AVP-A1HD è dotato di Diodi a Emissione Luminosa (LED). A unità accesa, all'interno dell'unità AVP-A1HD, si accende una luce di colore verde, che non indica alcun malfunzionamento.

### Precauzioni sull'installazione

#### Nota:

Per una dispersione adeguata del calore, non installare questa apparecchiatura in uno spazio ristretto, come ad esempio una libreria o simili.

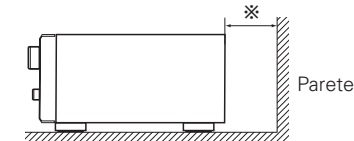
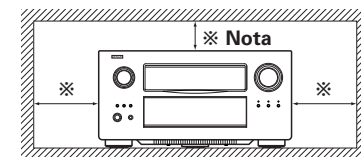

## Nomi delle parti e funzioni

## Pannello anteriore

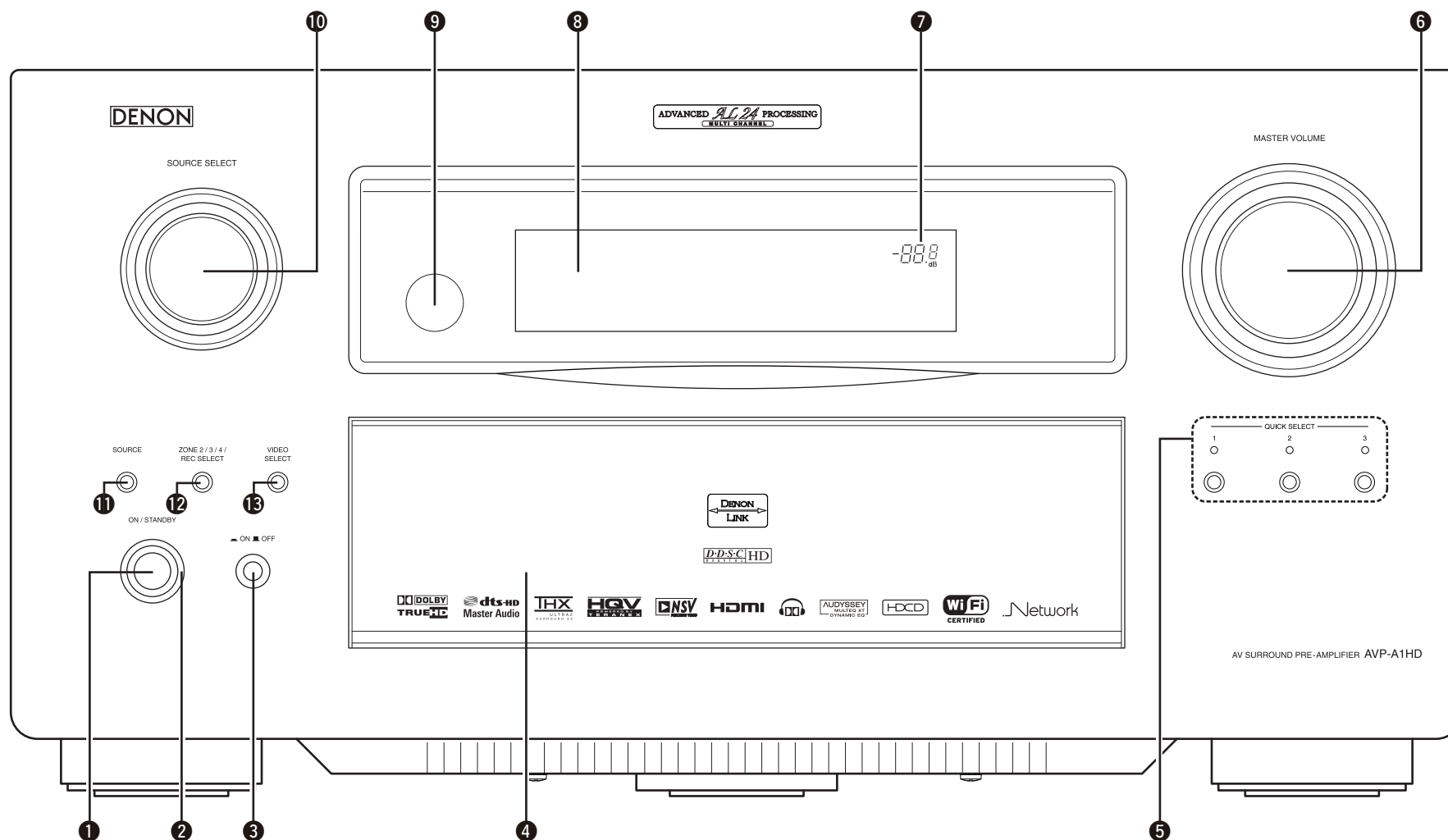

- ❶ Pulsante di alimentazione (ON/STANDBY)
- ❷ Indicatore di alimentazione
- ❸ Interruttore di accensione (ON OFF)
- ❹ Sportello
- ❺ Pulsanti / indicatori QUICK SELECT

- ❻ Manopola di controllo MASTER VOLUME
- ❼ Indicatore volume principale
- ❽ Display
- ❾ Sensore del telecomando

- ❿ Manopola SOURCE SELECT
- ⓫ Pulsante SOURCE
- ⓬ Pulsante ZONE 2/3/4 / REC SELECT
- ⓭ Pulsante VIDEO SELECT





Pannello posteriore

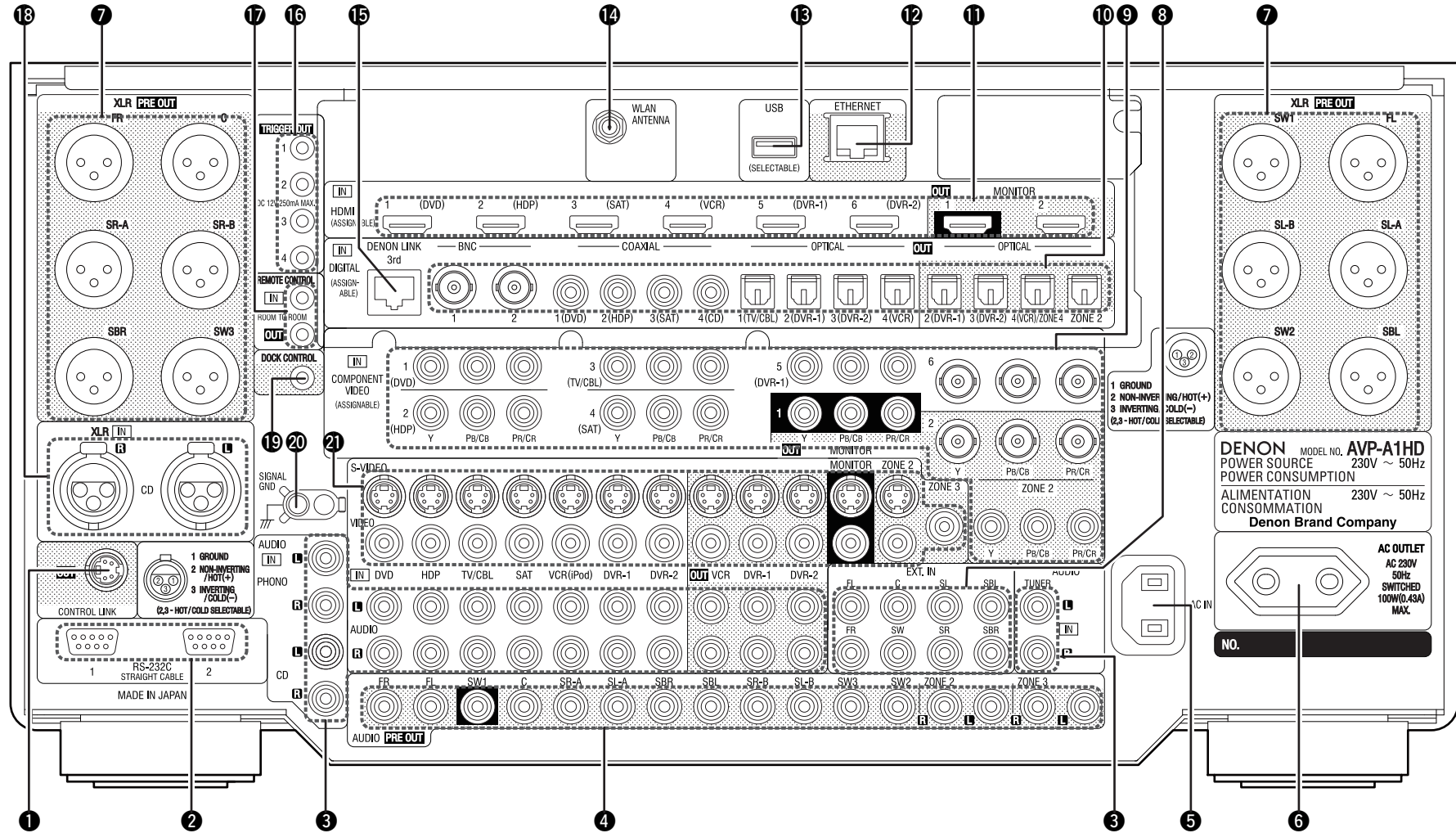

- |  |   |  |   |
|--|---|--|---|
| <ul style="list-style-type: none"> <li>❶ Connettore CONTROL LINK</li> <li>❷ Connettore RS-232C</li> <li>❸ Connettori audio analogico (AUDIO)</li> <li>❹ Connettori RCA PRE OUT</li> <li>❺ Ingresso CA (AC IN)</li> <li>❻ Presa CA (AC OUTLET)</li> </ul> | <ul style="list-style-type: none"> <li>❼ Connettori XLR PREOUT</li> <li>❽ Connettori EXT. IN</li> <li>❾ Connettori COMPONENT VIDEO</li> <li>❿ Connettori audio digitale (OPTICAL / COAXIAL / BNC)</li> <li>⓫ Connettori HDMI</li> </ul> | <ul style="list-style-type: none"> <li>⓬ Connettore ETHERNET</li> <li>⓭ Porta USB</li> <li>⓮ Terminale WLAN ANTENNA</li> <li>⓯ Connettore DENON LINK</li> <li>⓰ Prese TRIGGER OUT</li> <li>⓱ Prese REMOTE CONTROL</li> </ul> | <ul style="list-style-type: none"> <li>Ⓜ Connettori audio XLR (CD)</li> <li>Ⓨ Presa DOCK CONTROL</li> <li>Ⓩ Terminale SIGNAL GND</li> <li>ⓐ Connettori VIDEO / S-VIDEO</li> </ul> |
|--|---|--|---|

# Specifiche

## Sezione audio

### Analogico

<b>Sensibilità di ingresso / Impedenza di ingresso:</b>	Preuscita RCA (non bilanciata) : 200 mV / 47 kΩ/kohm Pre-uscita XLR (bilanciata) : 400 mV / 100 kΩ/kohms
<b>Risposta di frequenza:</b>	10 Hz ~ 100 kHz — +1, -3 dB (modo DIRECT)
<b>S/R:</b>	102 dB (IHFA weighted, modo DIRECT)
<b>Distorsione:</b>	0,005 % (20 Hz ~ 20 kHz, modo DIRECT)
<b>Uscita nominale:</b>	Preuscita RCA (non bilanciata) : 1,2 V Pre-uscita XLR (bilanciata) : 2,4 V

### Digitale

<b>Uscita D/A:</b>	Uscita nominale — 2 V (con riproduzione 0 dB) Distorsione armonica totale — 0,005 % (1 kHz, a 0 dB) Gamma dinamica — 110 dB
<b>Ingresso digitale:</b>	Formato — Interfaccia audio digitale

### Equalizzatore phono (ingresso PHONO — REC OUT)

<b>Sensibilità di ingresso:</b>	2,5 mV
<b>Deviazione RIAA:</b>	±1 dB (da 20 Hz a 20 kHz)
<b>S/R:</b>	74 dB (A weighting, con ingresso 5 mV)
<b>Uscita nominale:</b>	150 mV
<b>Fattore di distorsione:</b>	0,03 % (1 kHz, 3 V)

## Sezione video

### Connettori video standard

<b>Livello e impedenza di ingresso / uscita:</b>	1 Vp-p, 75 Ω/ohm
<b>Risposta di frequenza:</b>	5 Hz ~ 10 MHz — +0, -3 dB (con conversione video impostata su "Spento")

### Connettori S-Video

<b>Livello e impedenza di ingresso / uscita:</b>	Segnale Y (luminosità) — 1 Vp-p, 75 Ω/ohm Segnale C (colore) — 0,3 (PAL) / 0,286 (NTSC) Vp-p, 75 Ω/ohm
<b>Risposta di frequenza:</b>	5 Hz ~ 10 MHz — +0, -3 dB (con conversione video impostata su "Spento")

### Connettore video component colore

<b>Livello e impedenza di ingresso / uscita:</b>	Segnale Y (luminosità) — 1 Vp-p, 75 Ω/ohm Segnale P <sub>B</sub> / C <sub>B</sub> — 0,7 Vp-p, 75 Ω/ohm Segnale P <sub>R</sub> / C <sub>R</sub> — 0,7 Vp-p, 75 Ω/ohm
<b>Risposta di frequenza:</b>	5 Hz ~ 10 MHz — +0, -3 dB (con conversione video impostata su "Spento")

## LAN senza fili

<b>Tipo di rete (standard LAN senza fili):</b>	In conformità con IEEE 802.11b In conformità con IEEE 802.11g (in conformità con Wi-Fi®)*
<b>Velocità di trasferimento:</b>	DS-SS: 11 / 5,5 / 2 / 1 Mbps (commutazione automatica) OFDM: 54 / 48 / 36 / 24 / 18 / 12 / 9 / 6 Mbps (commutazione automatica)
<b>Sicurezza:</b>	SSID (nome rete) Chiave WEP (chiave rete) (64/128 bit) WPA-PSK (TKIP/AES) WPA2-PSK (TKIP/AES)
<b>Gamma di frequenza usata:</b>	2,412 MHz ~ 2,472 MHz
<b>Num. di canali:</b>	In conformità con IEEE 802.11b 13ch (DS-SS) (dei quali è usato 1 canale) In conformità con IEEE 802.11g 13ch (OFDM) (dei quali è usato 1 canale)

## Generale

<b>Alimentazione:</b>	CA 230 V, 50 Hz
<b>Consumo corrente:</b>	150 W 0,3 W (standby)
<b>Dimensioni esterne massime:</b>	434 (L) x 214 (A) x 485 (P) mm
<b>Massa:</b>	275 kg

## Telecomando principale (RC-1067)

<b>Batterie:</b>	Tipo LR6/AA (due batterie)
<b>Dimensioni esterne massime:</b>	63 (L) x 238 (A) x 31 (P) mm
<b>Massa:</b>	190 g (batterie incluse)

## Telecomando secondario (RC-1070)

<b>Batterie:</b>	Tipo R03/AAA (due batterie)
<b>Dimensioni esterne massime:</b>	49 (L) x 220 (A) x 24,5 (P) mm
<b>Massa:</b>	114 g (batterie incluse)

\*: La conformità Wi-Fi® garantisce un'interoperabilità testata e provata da Wi-Fi Alliance, un gruppo che certifica l'interoperabilità tra apparecchi LAN senza fili.

※ Per motivi di miglioramento del prodotto, le specifiche ed il design sono soggetti a modifiche senza preavviso.

# Primeros pasos

## Accesorios

Compruebe que el producto va acompañado de las piezas siguientes.

- ① Manual del usuario ..... 1
- ② CD-ROM (Manual del usuario) ..... 1
- ③ Lista de servicios técnicos ..... 1
- ④ Cable de suministro eléctrico (Longitud del cable: Aprox. 1,5 m) ... 1
- ⑤ Mando a distancia principal (RC-1067) ..... 1
- ⑥ Pila LR6/AA (para el RC-1067) ..... 2
- ⑦ Mando a distancia secundario (RC-1070) ..... 1
- ⑧ Pila R03/AAA (para el RC-1070) ..... 2
- ⑨ Antena de varilla ..... 1
- ⑩ Micrófono con base (Longitud del cable: Aprox. 7,6 m) ..... 1

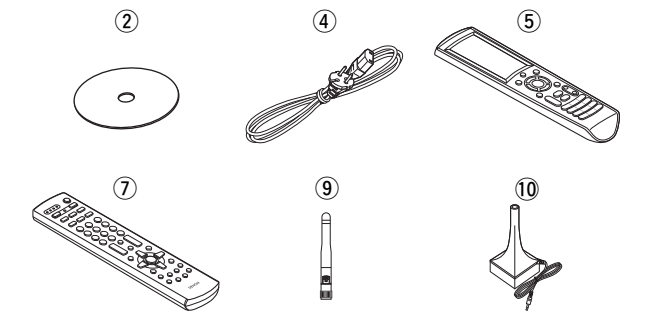

## Precauciones al manipular

- **Antes de encender el interruptor de alimentación**  
Compruebe de nuevo que todas las conexiones están correctamente hechas y que los cables no presentan problemas.
- La energía eléctrica se suministra a algunos sistemas de circuitos aún cuando la unidad se encuentra en modo de espera. Cuando salga de viaje o cuando vaya a estar ausente durante períodos prolongados, desconecte el cable de suministro eléctrico de la toma de corriente.
- **Acerca de la condensación**  
Si hay una gran diferencia entre la temperatura interna de la unidad y la temperatura circundante, se puede producir condensación (rocío) en las piezas internas de la unidad, impidiendo que funcione correctamente. Si esto sucediera, deje la unidad apagada durante una o dos horas y espere hasta que la diferencia de temperatura sea mínima antes de utilizar la unidad.
- **Precauciones con el uso de teléfonos móviles**  
Si se utiliza un teléfono móvil cerca de esta unidad puede que se produzcan ruidos. En tal caso, mueva el teléfono móvil lejos de esta unidad cuando esté en funcionamiento.
- **Mover la unidad**  
Apague el producto, desconecte el cable de suministro eléctrico de la fuente de alimentación. Después, desconecte los cables de conexión de otras unidades del sistema antes de mover la unidad.
- Note que las ilustraciones en estas instrucciones podrían diferir de la actual unidad para propósitos de explicación únicamente.
- En el circuito de AVP-A1HD se emplean Diodos emisores de luz (LED). Cuando reciben alimentación eléctrica, una luz verde aparece dentro de parte de la unidad AVP-A1HD, pero no se trata de un fallo.

## Precauciones durante la instalación

**Nota:**  
Para la dispersión del calor adecuadamente, no instale este equipo en un lugar confinado tal como una librería o unidad similar.

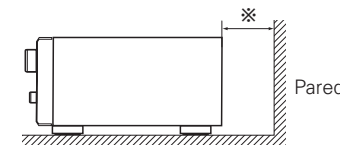
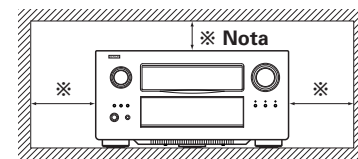

Nombres y funciones de las piezas

Panel delantero

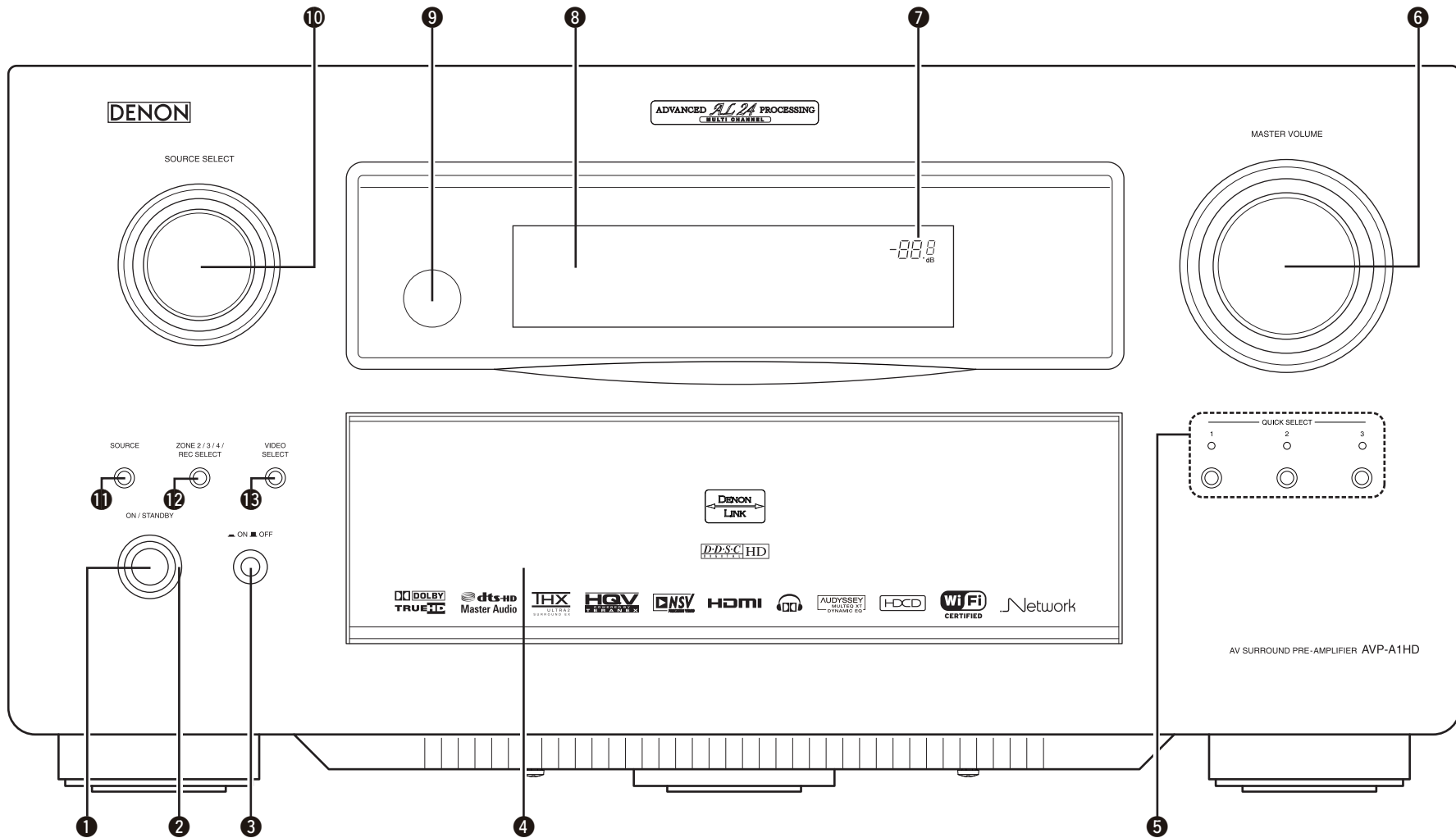

- ❶ Botón de alimentación (ON/STANDBY)
- ❷ Indicador de alimentación
- ❸ Interruptor de alimentación (ON / OFF)
- ❹ Puerta
- ❺ Botones / indicadores QUICK SELECT

- ❻ Control MASTER VOLUME
- ❼ Indicador de volumen principal
- ❽ Pantalla
- ❾ Sensor de mando a distancia

- ❿ Control SOURCE SELECT
- ⓫ Botón SOURCE
- ⓬ Botón ZONE 2/3/4 / REC SELECT
- ⓭ Botón VIDEO SELECT

[Con la tapa abierta]

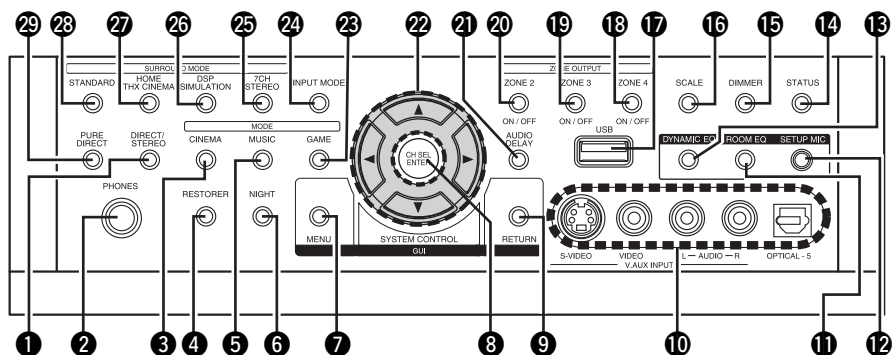

- 1 Botón DIRECT/STEREO
- 2 Conector de auriculares (PHONES)
- 3 Botón CINEMA
- 4 Botón RESTORER
- 5 Botón MUSIC
- 6 Botón NIGHT
- 7 Botón MENU
- 8 Botón CH SEL / ENTER
- 9 Botón RETURN
- 10 Conectores V.AUX INPUT
- 11 Botón ROOM EQ
- 12 Conector SETUP MIC
- 13 Botón DYNAMIC EQ
- 14 Botón STATUS
- 15 Botón DIMMER
- 16 Botón SCALE
- 17 Puerto USB
- 18 Botón ZONE4 ON/OFF
- 19 Botón ZONE3 ON/OFF
- 20 Botón ZONE2 ON/OFF
- 21 Botón AUDIO DELAY
- 22 Botones de cursor (▲▼◀▶)
- 23 Botón GAME
- 24 Botón INPUT MODE
- 25 Botón 7CH STEREO
- 26 Botón DSP SIMULATION
- 27 Botón HOME THX CINEMA
- 28 Botón STANDARD
- 29 Botón PURE DIRECT

Pantalla

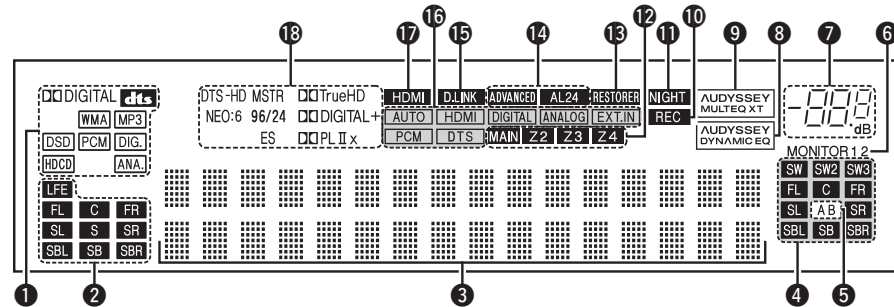

- 1 Indicadores de señal de entrada
- 2 Indicadores de canal de señal de entrada  
Se iluminan durante la recepción de señales digitales.
- 3 Sección de información  
Aquí se indica el nombre de la fuente de entrada, el modo surround, los valores de ajuste y otra información.
- 4 Indicadores de canal de señal de salida  
Se iluminan de acuerdo con los ajustes de los altavoces surround A y B.
- 5 Indicadores de altavoces surround  
Se iluminan de acuerdo con el ajuste de salida de monitor HDMI. Cuando se selecciona "Automática (Dual)"; los indicadores se iluminan según el estado de conexión.
- 6 Indicadores de salida de monitor  
Se iluminan de acuerdo con el ajuste de salida de monitor HDMI. Cuando se selecciona "Automática (Dual)"; los indicadores se iluminan según el estado de conexión.
- 7 Indicador de volumen principal
- 8 Indicador AUDYSSEY DYNAMIC EQ  
Se ilumina cuando se selecciona el Dynamic EQ de sala.
- 9 Indicador AUDYSSEY MULTEQ XT  
Se ilumina cuando se selecciona el ecualizador de sala.
- 10 Indicador de fuente de salida de grabación  
Se ilumina cuando se selecciona el modo REC OUT.
- 11 Indicador NIGHT  
Se ilumina cuando se selecciona el modo nocturno.
- 12 Indicadores multizona  
Se iluminan cuando se conecta la alimentación de la zona correspondiente.
- 13 Indicador RESTORER  
Se ilumina cuando se selecciona el modo RESTORER.
- 14 Indicador ADVANCED AL24  
Se ilumina cuando se activa la función Advanced AL24 Processing.
- 15 Indicador D.LINK  
Se ilumina durante la reproducción mediante conexiones DENON LINK.
- 16 Indicadores de modo de entrada
- 17 Indicador HDMI  
Se ilumina durante la reproducción mediante conexiones HDMI.
- 18 Indicadores de decodificador  
Se iluminan cuando los decodificadores correspondientes están en funcionamiento.

Panel trasero

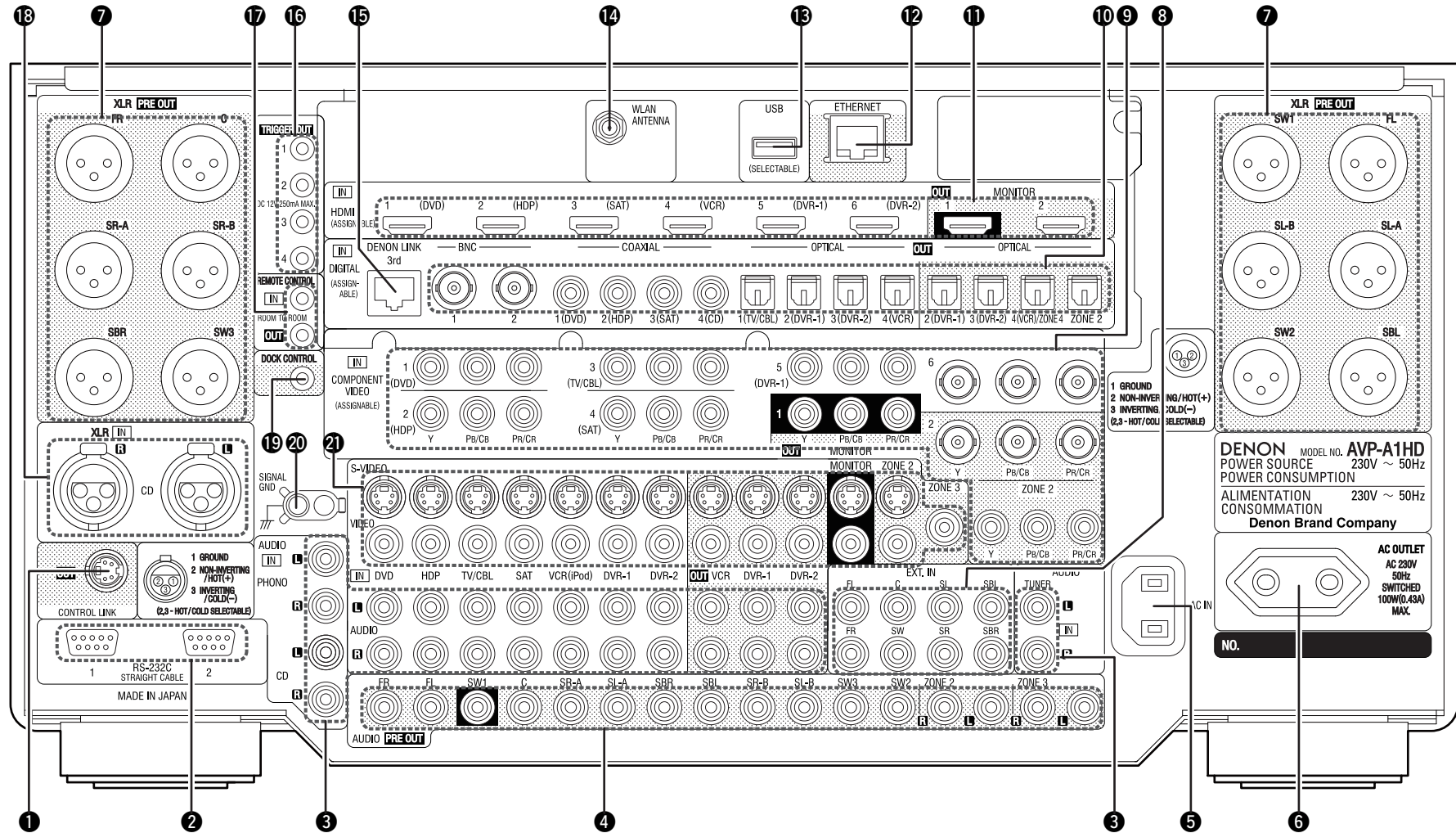

- 1 Conector CONTROL LINK
- 2 Conector RS-232C
- 3 Conectores de audio analógico (AUDIO)
- 4 Conectores RCA PRE OUT
- 5 Toma de AC (AC IN)
- 6 Salida de CA (AC OUTLET)

- 7 Conectores XLR PREOUT
- 8 Conectores EXT. IN
- 9 Conectores COMPONENT VIDEO
- 10 Conectores de audio digital (OPTICAL / COAXIAL / BNC)
- 11 Conectores HDMI

- 12 Conector ETHERNET
- 13 Puerto USB
- 14 Terminal WLAN ANTENNA
- 15 Conector DENON LINK
- 16 Conectores TRIGGER OUT
- 17 Conectores REMOTE CONTROL

- 18 Conectores audio XLR (CD)
- 19 Conector DOCK CONTROL
- 20 Terminal SIGNAL GND
- 21 Conectores VIDEO / S-VIDEO

DENON MODEL NO. AVP-A1HD  
 POWER SOURCE 230V ~ 50Hz  
 POWER CONSUMPTION  
 ALIMENTATION 230V ~ 50Hz  
 CONSUMMATION  
 Denon Brand Company

AC OUTLET  
 AC 230V  
 50Hz  
 SWITCHED  
 100W(0.43A)  
 MAX.

NO. [REDACTED]

# Especificaciones

## Sección de audio

### Analógico

<b>Sensibilidad de entrada / impedancia de entrada:</b>	Salida previa RCA (sin equilibrar): 200 mV / 47 k $\Omega$ /kohmios Salida previa XLR (equilibrada) : 400 mV / 100 k $\Omega$ /kohmios
<b>Frecuencia de respuesta:</b>	10 Hz ~ 100 kHz — +1, -3 dB (modo DIRECT)
<b>S/R:</b>	102 dB (IHFA pesado, modo DIRECT)
<b>Distorsión:</b>	0,005 % (20 Hz ~ 20 kHz, modo DIRECT)
<b>Salida nominal:</b>	Salida previa RCA (sin equilibrar) : 1,2 V Salida previa XLR (equilibrada) : 2,4 V

### Digital

<b>Salida D/A:</b>	Salida nominal — 2 V (reproducción a 0 dB) Distorsión armónica total — 0,005 % (1 kHz, a 0 dB) Margen dinámico — 110 dB
<b>Entrada digital:</b>	Formato — Interfaz de audio digital

### Ecuador fonográfico (entrada PHONO — REC OUT)

<b>Sensibilidad de entrada:</b>	2.5 mV
<b>Variación RIAA:</b>	$\pm$ 1 dB (20 Hz a 20 kHz)
<b>S/R:</b>	74 dB (ponderación A, con entrada de 5 mV)
<b>Salida nominal:</b>	150 mV
<b>Factor de distorsión:</b>	0,03 % (1 kHz, 3 V)

## Sección de vídeo

### Conectores de vídeo estándar

<b>Nivel de entrada/salida e impedancia:</b>	1 Vp-p, 75 $\Omega$ /ohmios
<b>Frecuencia de respuesta:</b>	5 Hz ~ 10 MHz — +0, -3 dB (cuando la función de conversión de vídeo está ajustada a "Desactivado")

### Conectores de S-Vídeo

<b>Nivel de entrada/salida e impedancia:</b>	Señal Y (luminosidad) — 1 Vp-p, 75 $\Omega$ /ohmios Señal C (color) — 0,3 (PAL) / 0,286 (NTSC) Vp-p, 75 $\Omega$ /ohmios
<b>Frecuencia de respuesta:</b>	5 Hz ~ 10 MHz — +0, -3 dB (cuando la función de conversión de vídeo está ajustada a "Desactivado")

### Conector de vídeo por componentes de color

<b>Nivel de entrada/salida e impedancia:</b>	Señal Y (luminosidad) — 1 Vp-p, 75 $\Omega$ /ohmios Señal P <sub>B</sub> / C <sub>B</sub> — 0,7 Vp-p, 75 $\Omega$ /ohmios Señal P <sub>R</sub> / C <sub>R</sub> — 0,7 Vp-p, 75 $\Omega$ /ohmios
<b>Frecuencia de respuesta:</b>	5 Hz ~ 10 MHz — +0, -3 dB (cuando la función de conversión de vídeo está ajustada a "Desactivado")

## LAN inalámbrica

<b>Tipo de red (estándar de LAN inalámbrica):</b>	Conforme a la norma IEEE 802.11b Conforme a la norma IEEE 802.11g (Conforme a Wi-Fi®)*
<b>Velocidad de transferencia:</b>	DS-SS: 11 / 5,5 / 2 / 1 Mbps (conmutación automática) OFDM: 54 / 48 / 36 / 24 / 18 / 12 / 9 / 6 Mbps (conmutación automática)
<b>Seguridad:</b>	SSID (nombre de red) Clave WEP (clave de red) (64/128 bits) WPA-PSK (TKIP/AES) WPA2-PSK (TKIP/AES)
<b>Gama de frecuencias utilizadas:</b>	2,412 MHz ~ 2,472 MHz
<b>Núm. de canales:</b>	Conforme a la norma IEEE 802.11b: 13 canales (DS-SS) (de cuales se utiliza 1 canal) Conforme a la norma IEEE 802.11g: 13 canales (OFDM) (de cuales se utiliza 1 canal)

## General

<b>Alimentación eléctrica:</b>	CA 230 V, 50 Hz
<b>Consumo de energía:</b>	150 W 0,3 W (modo de espera)
<b>Dimensiones externas máximas:</b>	434 (A) x 214 (A) x 485 (P) mm
<b>Peso:</b>	27,5 kg

## Mando a distancia principal (RC-1067)

<b>Baterías:</b>	Tipo LR6/AA (dos baterías)
<b>Dimensiones externas máximas:</b>	63 (A) x 238 (A) x 31 (P) mm
<b>Peso:</b>	190 g (incluyendo baterías)

## Mando a distancia secundario (RC-1070)

<b>Baterías:</b>	Tipo R03/AAA (dos baterías)
<b>Dimensiones externas máximas:</b>	49 (A) x 220 (A) x 24,5 (P) mm
<b>Peso:</b>	114 g (incluyendo baterías)

\*: La conformidad con Wi-Fi® indica una interoperabilidad probada por "Wi-Fi Alliance", un grupo que certifica la interoperabilidad entre dispositivos de LAN inalámbrica.

※ Con el propósito de introducir mejoras, las especificaciones y el diseño del equipo están sujetos a cambios sin previo aviso.



## Aan de slag

Dank u voor het vertrouwen dat u in dit DENON-product hebt gesteld. Lees deze gebruiksaanwijzing in zijn geheel aandachtig door om er zeker van kunt zijn dat u het toestel op de juiste wijze leert te bedienen. Bewaar deze gebruiksaanwijzing na hem te hebben gelezen voor toekomstig gebruik.

## Accessoires

Controleer of bij dit product de volgende onderdelen zijn meegeleverd.

①	Gebruiksaanwijzing .....	1
②	CD-ROM (Gebruiksaanwijzing) .....	1
③	Lijst van serviceadressen .....	1
④	Netsnoer (Snoerlengte: Ca. 1,5 m).....	1
⑤	Hoofdafstandsbediening (RC-1067).....	1
⑥	LR6/AA-batterijen (voor RC-1067).....	2
⑦	Tweede afstandsbediening (RC-1070).....	1
⑧	R03/AAA-batterijen (voor RC-1070).....	2
⑨	Staafantenne voor draadloze LAN-verbinding .....	1
⑩	Setup-microfoon (Snoerlengte: Ca. 7,6 m).....	1

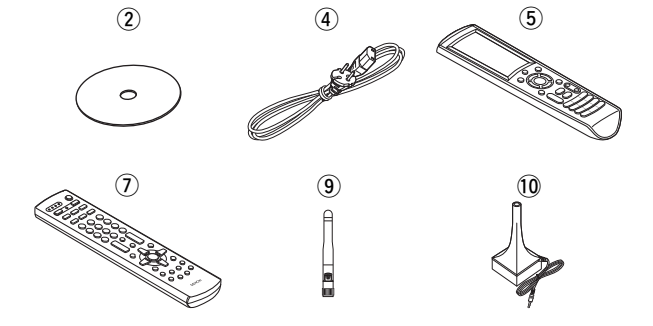

## Vorzorgsmaatregelen voor het gebruik

- **Alvorens de spanning in te schakelen**  
Controleer nogmaals of alle aansluitingen juist zijn en of er geen problemen zijn met de aansluitsnoeren.
- Zelfs wanneer het toestel met de netschakelaar stand-by is gezet, verbruiken enkele circuits een bepaalde hoeveelheid stroom. Trek de stekker van het netsnoer uit het stopcontact wanneer u op reis gaat of gedurende langere tijd van huis bent.
- **Over condensvorming**  
Als er grote verschillen zijn tussen de temperatuur in het toestel en daarbuiten, dan kunnen er op sommige werkende onderdelen binnen in de eenheid waterdruppels (condens) verschijnen waardoor het toestel mogelijk niet naar behoren functioneert. Wanneer dit zich voordoet laat u het het toestel gedurende een paar uren met uitgeschakelde netspanning staan en wacht u totdat het temperatuurverschil is afgenomen voordat u het toestel weer in gebruik neemt.
- **Waarschuwingen voor het gebruik van mobiele telefoons**  
Het gebruiken van een mobiele telefoon in de buurt van dit toestel kan ruis tot gevolg hebben. Vergroot in dat geval de afstand tussen het toestel en de mobiele telefoon tijdens het gebruik.
- **Verplaatsen van het toestel**  
Schakel de netspanning uit en trek de stekker van het netsnoer uit het stopcontact. Koppel vervolgens ook de aansluitsnoeren naar andere systeemcomponenten los voordat u het toestel verplaatst.
- De afbeeldingen in deze gebruiksaanwijzing kunnen ten behoeve van de duidelijkheid afwijken van het werkelijke toestel.
- Er worden Light Emitting Diodes (LED) gebruikt in het AVP-A1HD circuit. Bij inschakeling is een groen licht zichtbaar in de AVP-A1HD, maar dit is geen storing.

## Vorzorgsmaatregelen bij de installatie

**Opmerking:**  
Plaats dit toestel niet in een kleine afgesloten ruimte, zoals een boekenkast e.d., omdat anders de warmte niet op gepaste wijze kan worden afgevoerd.

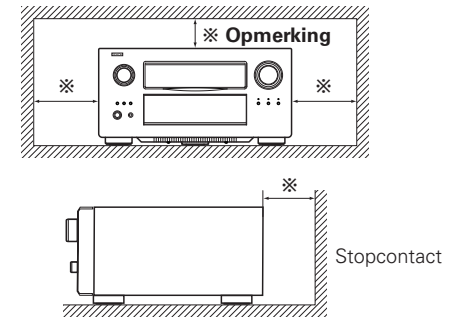

# Namen en functies van onderdelen

## Voorpaneel

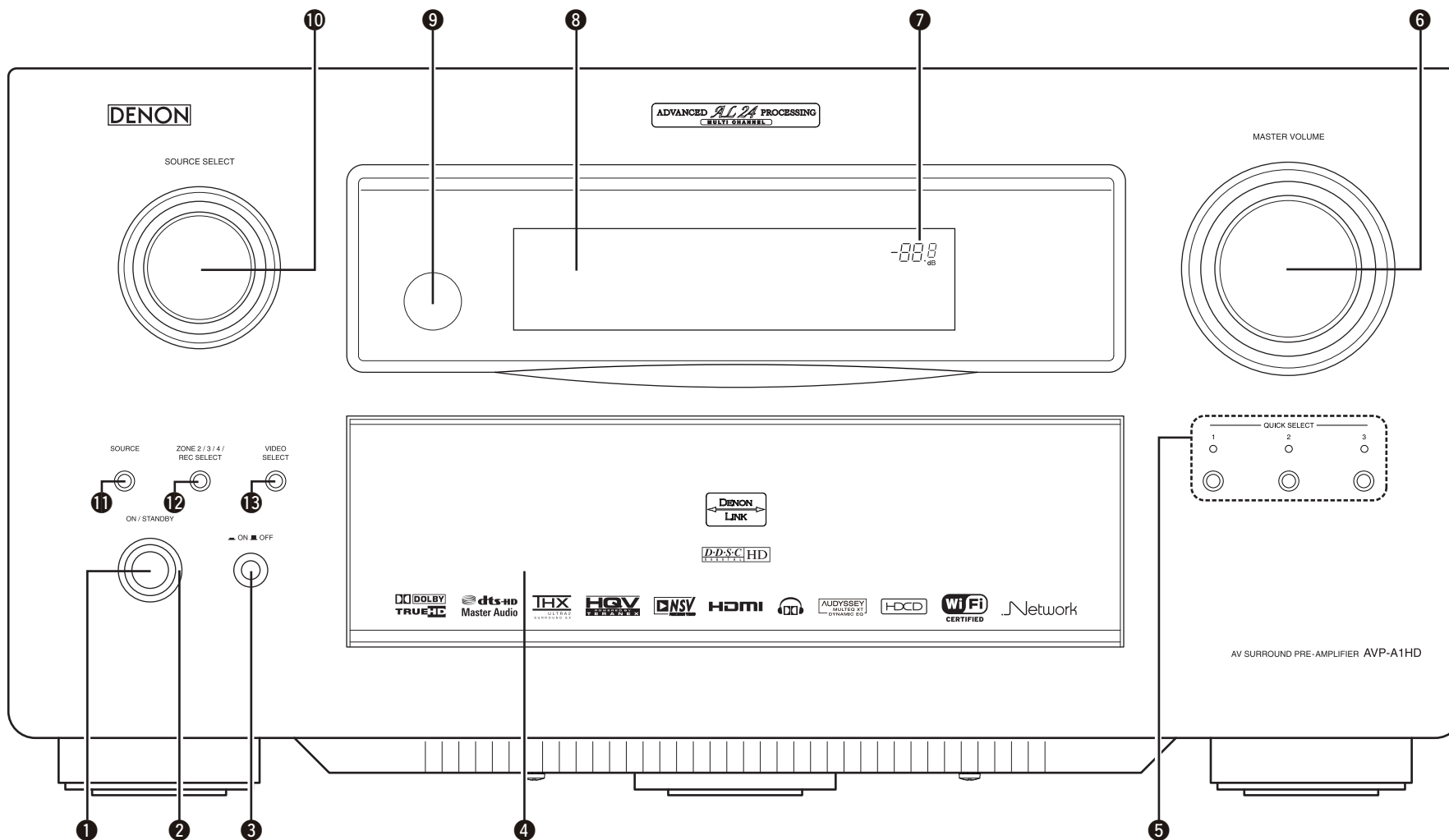

- ❶ Netspanningstoets (ON/STANDBY)
- ❷ Netspanningsindicator
- ❸ Hoofdschakelaar (ON/OFF)
- ❹ Klep
- ❺ QUICK SELECT-toetsen / indicators

- ❻ MASTER VOLUME-regelaar
- ❼ Hoofdvolume-indicator
- ❽ Display
- ❾ Afstandsbedieningssensor

- ❿ SOURCE SELECT-regelaar
- ⓫ SOURCE-toets
- ⓬ ZONE 2/3/4 / REC SELECT-toets
- ⓭ VIDEO SELECT-toets

[Met geopend paneel]

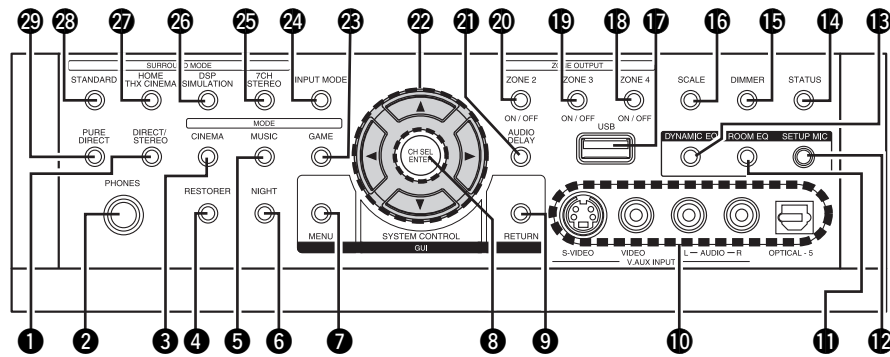

- 1 DIRECT/STEREO-toets
- 2 Hoofdtelefoonaansluiting (PHONES)
- 3 CINEMA-toets
- 4 RESTORER-toets
- 5 MUSIC-toets
- 6 NIGHT-toets
- 7 MENU-toets
- 8 CH SEL / ENTER-toets
- 9 RETURN-toets
- 10 V.AUX INPUT-aansluitingen
- 11 ROOM EQ-toets
- 12 SETUP MIC-aansluiting
- 13 DYNAMIC EQ-toets
- 14 STATUS-toets
- 15 DIMMER-toets
- 16 SCALE-toets
- 17 USB-poort
- 18 ZONE4 ON/OFF-toets
- 19 ZONE3 ON/OFF-toets
- 20 ZONE2 ON/OFF-toets
- 21 AUDIO DELAY-toets
- 22 Cursortoetsen (Δ ▽ ◀ ▶)
- 23 GAME-toets
- 24 INPUT MODE-toets
- 25 7CH STEREO-toets
- 26 DSP SIMULATION-toets
- 27 HOME THX CINEMA-toets
- 28 STANDARD-toets
- 29 PURE DIRECT-toets

Display

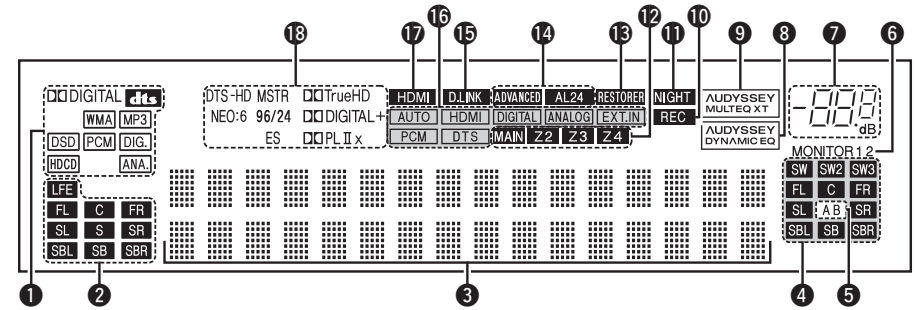

- 1 Ingangssignaalindicatoren
- 2 Kanaalindicatoren voor het ingangssignaal  
Deze indicators lichten op bij invoer van een digitaal signaal.
- 3 Informatiedisplay  
Hier worden de naam van de ingangsbron, de surroundmodus, instelwaarden en overige informatie getoond.
- 4 Kanaalindicatoren voor het uitgangssignaal
- 5 Surround luidsprekerindicatoren  
Deze indicators lichten afhankelijk van de instellingen van de surround luidsprekers A en B op.
- 6 Monitoruitgangindicatoren  
Deze indicators lichten afhankelijk van de instelling van de HDMI-monitoruitgang op. Bij instelling op "Automatisch (Dual)" lichten de indicators afhankelijk van de verbindingstatus op.
- 7 Hoofdvolume-indicator
- 8 AUDYSSEY DYNAMIC EQ-indicator  
Deze indicator licht op wanneer de Dynamic EQ is geselecteerd.
- 9 AUDYSSEY MULTEQ XT-indicator  
Deze indicator licht op wanneer de kamerequalizer is geselecteerd.
- 10 Opnameuitgangsbronindicator  
Deze indicator licht op wanneer de REC OUT-modus is geselecteerd.
- 11 NIGHT-indicator  
Deze indicator licht op wanneer de nachtmodus is geselecteerd.
- 12 Multi-zone indicators  
Deze indicators lichten op wanneer de bijbehorende zones worden ingeschakeld.
- 13 RESTORER-indicator  
Deze indicator licht op wanneer de RESTORER-functie is geselecteerd.
- 14 ADVANCED AL24-indicator  
Deze indicator licht op wanneer Advanced AL24 Processing is geactiveerd.
- 15 D.LINK-indicator  
Deze indicator licht op tijdens weergave met gebruik van een DENON LINK-aansluiting.
- 16 Ingangsmodusindicatoren
- 17 HDMI-indicator  
Deze indicator licht op tijdens weergave met gebruik van een HDMI-aansluiting.
- 18 Decoderindicatoren  
Deze indicators lichten op wanneer de bijbehorende decoders in werking zijn.

Achterpaneel

Aan de slag Technische gegevens

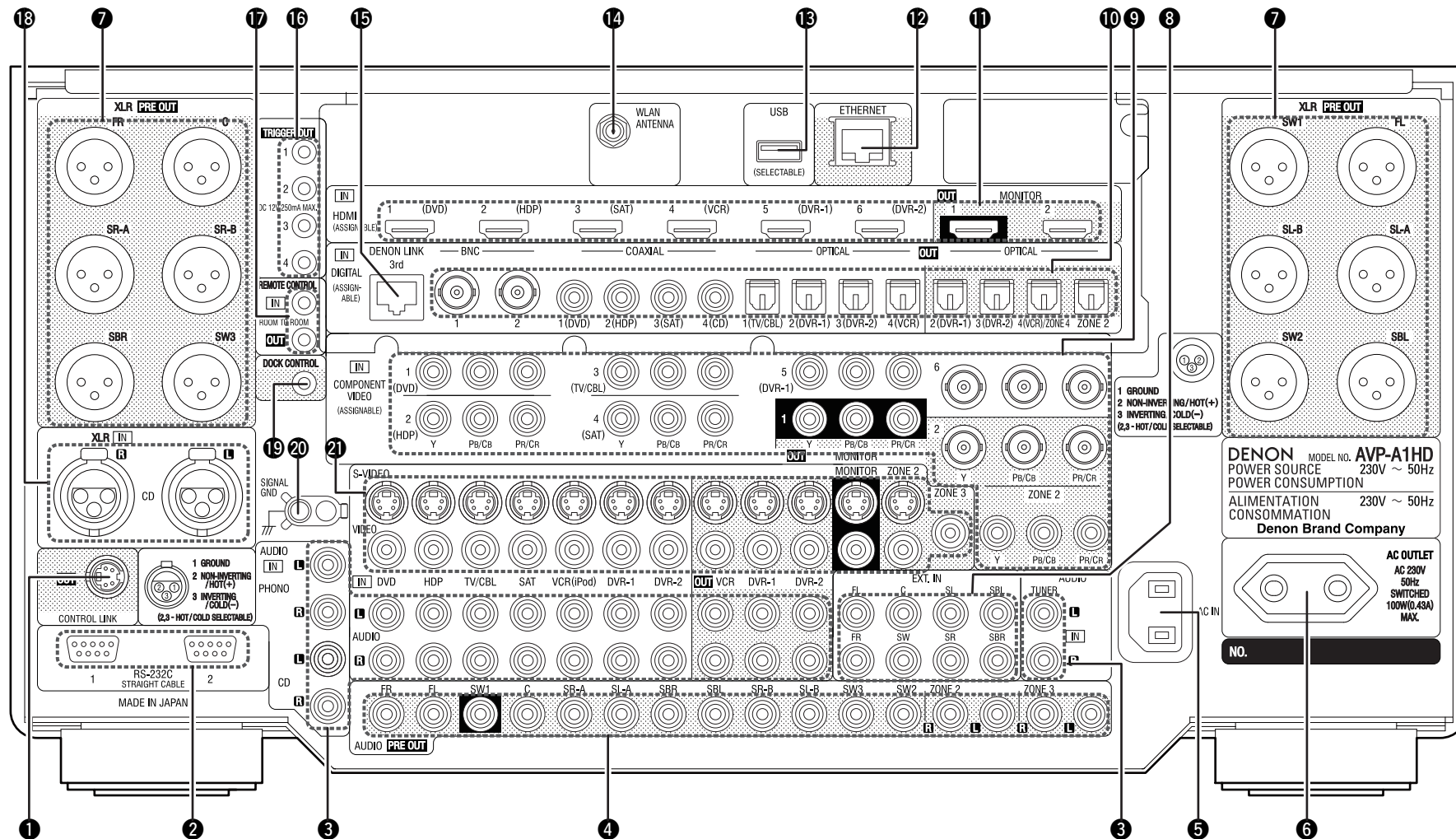

- 1 CONTROL LINK-aansluiting
- 2 RS-232C-aansluiting
- 3 Analoge audio-aansluitingen (AUDIO)
- 4 RCA PRE OUT-aansluitingen
- 5 AC Netingang (AC IN)
- 6 AC-netuitgang (AC OUTLET)
- 7 XLR PREOUT-aansluitingen
- 8 EXT. IN-aansluitingen
- 9 COMPONENT VIDEO-aansluitingen
- 10 Digitale audio-aansluitingen (OPTICAL / COAXIAL / BNC)
- 11 HDMI-aansluitingen
- 12 ETHERNET-aansluiting
- 13 USB-poort
- 14 WLAN ANTENNA-aansluiting
- 15 DENON LINK-aansluitin
- 16 TRIGGER OUT-aansluitingen
- 17 REMOTE CONTROL-aansluitingen
- 18 XLR audio-aansluitingen (CD)
- 19 DOCK CONTROL-aansluiting
- 20 SIGNAL GND-aansluiting
- 21 VIDEO / S-VIDEO-aansluitingen

# Technische gegevens

## Audio gedeelte

### Analoog

**Ingangsgevoeligheid / Ingangsimpedantie:** RCA Voor-output (niet-gebalanceerd) : 200 mV / 47 kΩ/kohms  
 XLR Voor-output (gebalanceerd) : 400 mV / 100 kΩ/kohms  
 10 Hz ~ 100 kHz — +1, -3 dB (DIRECT-modus)  
**Frequentieweergave:** 102 dB (IHF-A gewogen, DIRECT-modus)  
**Signaal-ruis verhouding:** 0,005 % (20 Hz ~ 20 kHz, DIRECT-modus)  
**Vervorming:** RCA Voor-output (niet-gebalanceerd) : 1,2 V  
 XLR Voor-output (gebalanceerd) : 2,4 V

### Digitaal

**D/A-uitgang:** Nominaal — 2 V (bij 0 dB weergave)  
 Totale harmonische vervorming — 0,005 % (1 kHz, bij 0 dB)  
 Dynamisch bereik — 110 dB  
 Formaat — Digitale audio-interface

### Digitale ingang:

### Phono-equalizer (PHONO-ingang — REC OUT)

**Ingangsgevoeligheid:** 2,5 mV  
**RIAA-afwijking:** ±1 dB (20 Hz tot 20 kHz)  
**Signaal-ruis verhouding:** 74 dB (A-gewogen, met 5 mV ingang)  
**Nominaal vermogen:** 150 mV  
**Vervormingsfactor:** 0,03 % (1 kHz, 3 V)

## Video gedeelte

### Standaard video-aansluitingen

**Ingangs- / uitgangsniveau en -impedantie:** 1 Vp-p, 75 Ω/ohm  
**Frequentieweergave:** 5 Hz ~ 10 MHz — +0, -3 dB (met videoconversie "UIT")

### S-Video-aansluitingen

**Ingangs- / uitgangsniveau en -impedantie:** Y (helderheid) -signaal — 1 Vp-p, 75 Ω/ohm  
 C (kleur) -signaal — 0,3 (PAL) / 0,286 (NTSC) Vp-p, 75 Ω/ohm  
**Frequentieweergave:** 5 Hz ~ 10 MHz — +0, -3 dB (met videoconversie "UIT")

### Kleurencomponentvideo-aansluitingen

**Ingangs- / uitgangsniveau en -impedantie:** Y (helderheid) -signaal — 1 Vp-p, 75 Ω/ohm  
 Pb / Cb-sigitaal — 0,7 Vp-p, 75 Ω/ohm  
 Pr / Cr-sigitaal — 0,7 Vp-p, 75 Ω/ohm  
**Frequentieweergave:** 5 Hz ~ 10 MHz — +0, -3 dB (met videoconversie "UIT")

## Draadloos LAN

**Netwerktipe (draadloze LAN normen):** Conform IEEE 802.11b  
 Conform IEEE 802.11g  
 (Conform Wi-Fi®)\*  
**Overdrachtssnelheid:** DS-SS: 11 / 5,5 / 2 / 1 Mbps (automatische omschakeling)  
 OFDM: 54 / 48 / 36 / 24 / 18 / 12 / 9 / 6 Mbps (automatische omschakeling)  
**Beveiliging:** SSID (netwerknnaam)  
 WEP-sleutel (netwerksleutel) (64/128 bits)  
 WPA-PSK (TKIP/AES)  
 WPA2-PSK (TKIP/AES)  
**Gebruik frequentiebereik:** 2,412 MHz ~ 2,472 MHz  
**Aantal kanalen:** Conform IEEE 802.11b: 13ch (DS-SS) (waarvan 1 gebruikt)  
 Conform IEEE 802.11g: 13ch (OFDM) (waarvan 1 gebruikt)

## Algemeen

**Voeding:** 230 V wisselstroom, 50 Hz  
**Stroomverbruik:** 150 W  
 0,3 W (stand-by)  
**Maximale buitenafmetingen:** 434 (B) x 214 (H) x 485 (D) mm  
**Gewicht:** 275 kg

## Hoofdafstandsbediening (RC-1067)

**Batterijen:** LR6/AA-type (twee batterijen)  
**Maximale buitenafmetingen:** 63 (B) x 238 (H) x 31 (D) mm  
**Gewicht:** 190 g (batterijen inbegrepen)

## Tweede afstandsbediening (RC-1070)

**Batterijen:** R03/AAA-type (twee batterijen)  
**Maximale buitenafmetingen:** 49 (B) x 220 (H) x 24,5 (D) mm  
**Gewicht:** 114 g (batterijen inbegrepen)

\*: Wi-Fi®-conformiteit duidt op het zijn getest en geschikt bevonden door de "Wi-Fi Alliance", een groep die de geschiktheid van draadloze netwerkaapraten garandeert.

※ Veranderingen in technische gegevens en ontwerp voorbehouden.

## Komma igång

### Tillbehör

Kontrollera att följande saker levereras tillsammans med produkten.

① Bruksanvisning .....	1
② CD-ROM (Bruksanvisning).....	1
③ Förteckning över serviceställen.....	1
④ Nätkabel (Kabellängd: Cirka 1,5 m).....	1
⑤ Huvudfjärrkontroll (RC-1067) .....	1
⑥ LR6/AA-batterier (för RC-1067).....	2
⑦ Extrafjärrkontroll (RC-1070).....	1
⑧ R03/AAA-batterier (för RC-1070).....	2
⑨ Stavantenn för trådlöst nätverk .....	1
⑩ Mätmikrofon (Kabellängd: Cirka 7,6 m).....	1

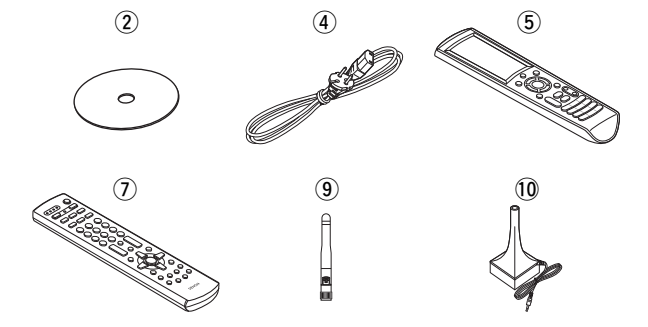

### Försiktighet vid hanteringen

#### • Innan du slår på strömmen

Gör en sista kontroll att alla anslutningar är riktigt gjorda och att det inte är något fel på anslutningskablarna.

- En del kretsar strömförsörjs även om apparaten ställs i standby-läget. När du åker på semester eller är hemifrån under längre tid, ska du därför koppla loss nätkabeln från eluttaget för att helt bryta strömförsörjningen till apparaten.

#### • Angående kondens

Om det finns stora temperaturskillnader mellan apparatens inre och omgivningen, kan kondens bildas på delarna inuti apparaten, vilket gör att apparaten inte fungerar korrekt.

Om detta inträffar ska du låta apparaten stå i en timme eller två med strömmen av och vänta tills temperaturen i apparaten är ungefär samma som i omgivningen.

#### • Försiktighetsmått avseende mobiltelefoner

Om en mobiltelefon används nära enheten kan det orsaka ett oljud. Flytta i så fall mobiltelefonen bort från enheten när den används.

#### • Flyttning av apparaten

Stäng av strömmen och koppla loss nätkabeln från eluttaget. Koppla sedan loss alla anslutningskablar innan enheten flyttas.

- Observera att bilderna i denna bruksanvisning ur förklaringsyfte kan skilja sig något från enheten.
- Ljusedioder (LED) används i AVP-A1HD-kretsen. När strömmen är på visas ett grönt ljus i delar av AVP-A1HD, men detta är inget fel.

### Försiktighet vid installationen

#### Observera:

För att tillförsäkra god värmeavledning får utrustningen inte installeras i instängda utrymmen, som t.ex. en bokhylla eller liknande.

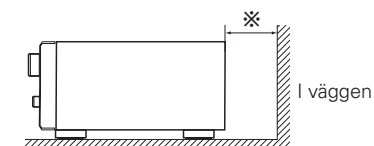
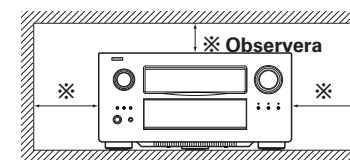

## De olika delarna och deras funktioner

## Frontpanelen

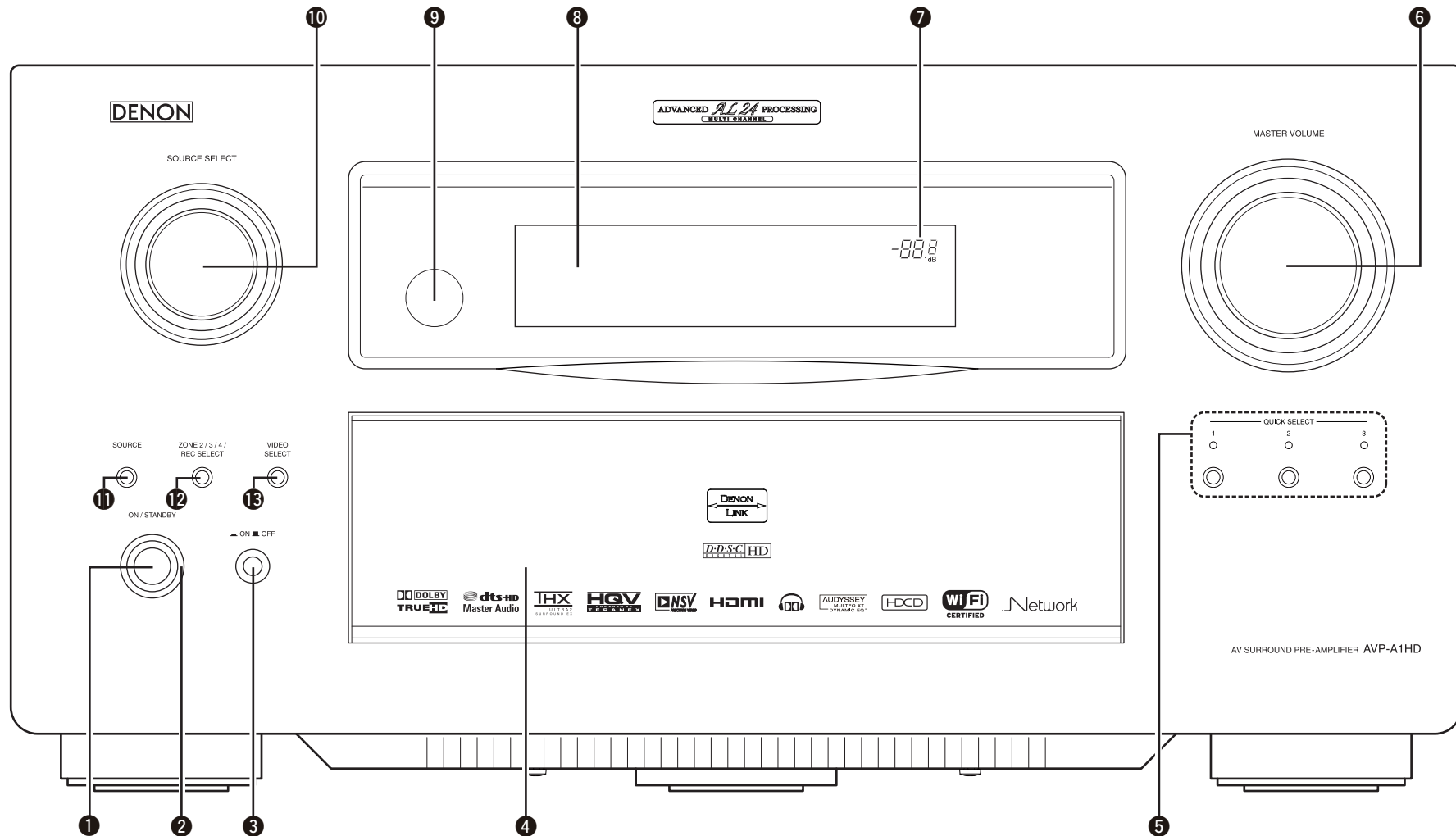

- ❶ Strömbrytare (ON/STANDBY)
- ❷ Strömindikator
- ❸ Huvudströmbrytare (ON OFF)
- ❹ Dörr
- ❺ QUICK SELECT-tangenter / indikatorer

- ❻ MASTER VOLUME-kontroll
- ❼ Huvudvolymindikator
- ❽ Display
- ❾ Fjärrkontrollsensor

- ❿ SOURCE SELECT-kontroll
- ⓫ SOURCE-tangent
- ⓬ ZONE 2/3/4 / REC SELECT-tangent
- ⓭ VIDEO SELECT-tangent

[Med frontluckan öppen]

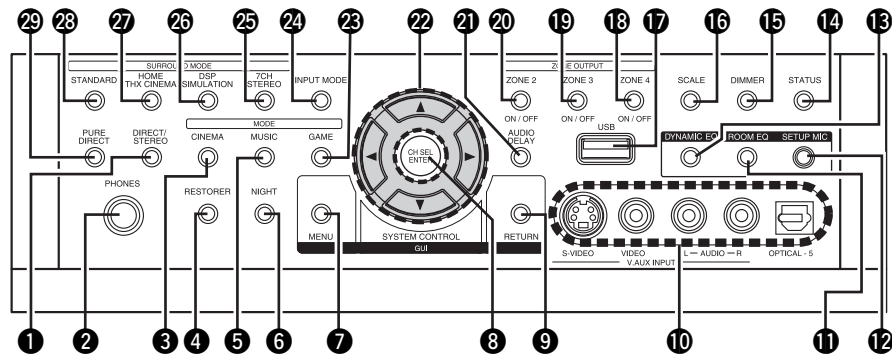

- 1 DIRECT/STEREO-tangent
- 2 Hörlursuttag (PHONES)
- 3 CINEMA-tangent
- 4 RESTORER-tangent
- 5 MUSIC-tangent
- 6 NIGHT-tangent
- 7 MENU-tangent
- 8 CH SEL / ENTER-tangent
- 9 RETURN-tangent
- 10 V.AUX INPUT-anslutningar
- 11 ROOM EQ-tangent
- 12 SETUP MIC-anslutning
- 13 DYNAMIC EQ-tangent
- 14 STATUS-tangent
- 15 DIMMER-tangent
- 16 SCALE-tangent
- 17 USB-port
- 18 ZONE4 ON/OFF-tangent
- 19 ZONE3 ON/OFF-tangent
- 20 ZONE2 ON/OFF-tangent
- 21 AUDIO DELAY-tangent
- 22 Piltangenter (Δ ▽ ◀ ▶)
- 23 GAME-tangent
- 24 INPUT MODE-tangent
- 25 7CH STEREO-tangent
- 26 DSP SIMULATION-tangent
- 27 HOME THX CINEMA-tangent
- 28 STANDARD-tangent
- 29 PURE DIRECT-tangent

Visning

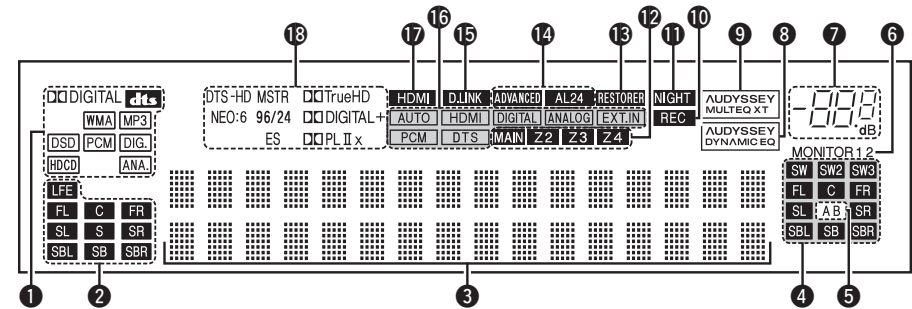

- 1 Indikatorer för ingångssignal
- 2 Kanalindikatorer för ingångssignalen  
Dessa indikatorer lyser när digitala signaler tas emot.
- 3 Informationsfönster  
Detta fönster visar källan, surroundläget, inställningsvärden och annan praktisk information.
- 4 Kanalindikatorer för utgångssignalen
- 5 Indikatorer för surroundhögtalare  
Dessa indikatorer lyser beroende på inställningarna för surround A- och B-högtalarna.
- 6 Indikatorer för bildskärmsutgång  
Dessa indikatorer lyser beroende på inställningarna för HDMI-videoutgången. I läget "Auto (två skärmar)", lyser indikatorerna beroende på anslutningens status.
- 7 Huvudvolymindikator
- 8 Indikatorer för AUDYSSEY DYNAMIC EQ  
Denna indikator lyser när Dynamic EQ har valts.
- 9 AUDYSSEY MULTEQ XT-indikator  
Denna indikator lyser när rumsequalizern används.
- 10 Indikator för inspelningsutgång  
Denna indikator lyser när REC OUT-läget har valts.
- 11 NIGHT-indikator  
Denna indikator lyser när nattläget har valts.
- 12 Multizonindikatorer  
Dessa indikatorer lyser när strömmen för någon av de andra zonerna är på.
- 13 RESTORER-indikator  
Denna indikator lyser RESTORER-läget har valts.
- 14 ADVANCED AL24-indikator  
Denna indikator lyser när Advanced AL24-signalbehandling används.
- 15 D.LINK-indikator  
Denna indikator lyser vid avspelning över DENON LINK-anslutningarna.
- 16 Indikatorer för ingångsläge
- 17 HDMI-indikator  
Denna indikator lyser vid avspelning över HDMI-anslutningarna.
- 18 Avkodarindikatorer  
Dessa indikatorer visar vilken avkodare som används.



Bakpanelen

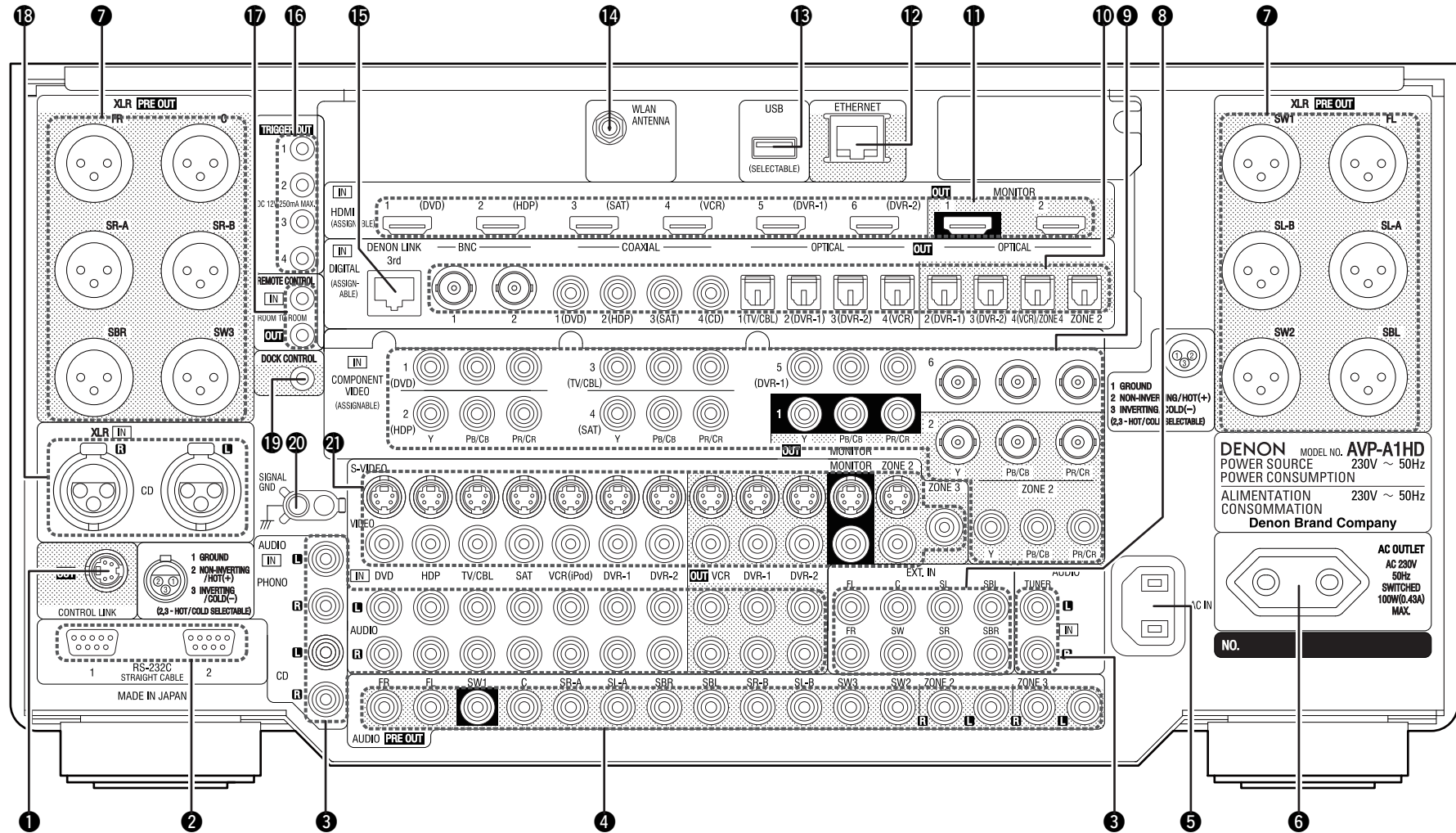

- 1 CONTROL LINK-anslutning
- 2 RS-232C-anslutning
- 3 Analoga ljudanslutningar (AUDIO)
- 4 RCA PRE OUT-anslutningar
- 5 Elanslutning (AC IN)
- 6 Eluttag (AC OUTLET)

- 7 XLR PREOUT-anslutningar
- 8 EXT. IN-anslutningar
- 9 COMPONENT VIDEO-anslutningar
- 10 Digitala ljudanslutningar (OPTICAL / COAXIAL / BNC)
- 11 HDMI-anslutningar

- 12 ETHERNET-anslutning
- 13 USB-port
- 14 WLAN ANTENNA-anslutning
- 15 DENON LINK-anslutning
- 16 TRIGGER OUT-uttag
- 17 REMOTE CONTROL-uttag

- 18 XLR ljudanslutningar (CD)
- 19 DOCK CONTROL-uttag
- 20 SIGNAL GND-anslutning
- 21 VIDEO / S-VIDEO-anslutningar

DENON MODEL NO. AVP-A1HD  
 POWER SOURCE 230V ~ 50Hz  
 POWER CONSUMPTION  
 ALIMENTATION CONSUMMATION 230V ~ 50Hz  
 Denon Brand Company

AC OUTLET  
 AC 230V  
 50Hz  
 SWITCHED  
 100W(0.43A)  
 MAX.

NO. [REDACTED]

# Tekniska data

## Ljuddelen

- Analog**  
**Insignalkänslighet / inimpedans:** RCA-Pre-utgång (obalanserad) : 200 mV / 47 k $\Omega$ /kohm  
 XLR-Pre-utgång (balanserad) : 400 mV / 100 k $\Omega$ /kohm  
 10 Hz ~ 100 kHz — +1, -3 dB (DIRECT-läget)  
**Frekvensgång:** 102 dB (IHF-A-vägt, DIRECT-läget)  
**Signal-/brusförhållande:** 102 dB (IHF-A-vägt, DIRECT-läget)  
**Distorsion:** 0,005 % (20 Hz ~ 20 kHz) (DIRECT-läget)  
**Märkeffekt:** RCA-Pre-utgång (obalanserad) : 1,2 V  
 XLR-Pre-utgång (balanserad) : 2,4 V
- Digital**  
**D/A-utgång:** Märknivå — 2 V (vid 0 dB avspelnig)  
 Total harmonisk distorsion — 0,005 % (1 kHz, vid 0 dB)  
 Dynamiskt omfång — 110 dB  
 Format — Digitalt ljudgränssnitt  
**Digitalingång:**
- Phono-equalizer (PHONO-ingång — REC OUT)**  
**Inkänslighet:** 2,5 mV  
**RIAA-avvikelse:**  $\pm 1$  dB (20 Hz till 20 kHz)  
**Signal-/brusförhållande:** 74 dB (A-vägt, med 5 mV-insignal)  
**Märkeffekt:** 150 mV  
**Distorsionsfaktor:** 0,03 % (1 kHz, 3 V)
- Videodelen**
  - Standard videoanslutningar**  
**In-/utnivå och impedans:** 1 Vt-t, 75  $\Omega$ /ohm  
**Frekvensgång:** 5 Hz ~ 10 MHz — +0, -3 dB (när videokonvertering är "AV")
  - S-videoanslutningar**  
**In-/utnivå och impedans:** Y-signal (ljusstyrka) — 1 Vt-t, 75  $\Omega$ /ohm  
 C-signal (färg) — 0,3 (PAL) / 0,286 (NTSC) Vt-t, 75  $\Omega$ /ohm  
 5 Hz ~ 10 MHz — +0, -3 dB (när videokonvertering är "AV")
  - Frekvensgång:**
  - Komponentvideoanslutning, färg**  
**In-/utnivå och impedans:** Y-signal (ljusstyrka) — 1 Vt-t, 75  $\Omega$ /ohm  
 Pb / Ca-signal — 0,7 Vt-t, 75  $\Omega$ /ohms  
 Pr / Cr-signal — 0,7 Vt-t, 75  $\Omega$ /ohm  
 5 Hz ~ 100 MHz — +0, -3 dB (när videokonvertering är "AV")
  - Frekvensgång:**

## Trådlöst nätverk

- Nätverkstyp (Trådlös nätverksstandard):** Uppfyller IEEE 802.11b  
 Uppfyller IEEE 802.11g  
 (Uppfyller Wi-Fi®)\*
- Överföringshastighet:** DS-SS: 11 / 5,5 / 2 / 1 Mbps (automatisk växling)  
 OFDM: 54 / 48 / 36 / 24 / 18 / 12 / 9 / 6 Mbps (automatisk växling)
- Säkerhet:** SSID (nätverksnamn)  
 WEP-nyckel (nätverksnyckel) (64/128 bitar)  
 WPA-PSK (TKIP/AES)  
 WPA2-PSK (TKIP/AES)
- Kommunikationsfrekvenser:** 2,412 MHz ~ 2,472 MHz
- Antal kanaler:** Enligt IEEE 802.11b: 13 kanaler (DS-SS) (bland vilka 1 kanal används)  
 Enligt IEEE 802.11g: 13 kanaler (OFDM) (bland vilka 1 kanal används)

## Allmänt

- Nätspänning:** 230 V växelström, 50 Hz
- Effektförbrukning:** 150 W  
 0,3 W (standby)
- Största yttermått:** 434 (B) x 214 (H) x 485 (D) mm
- Vikt:** 275 kg

## Huvudfjärrkontrollen (RC-1067)

- Batterier:** Typ LR6/AA (två batterier)
- Största yttermått:** 63 (B) x 238 (H) x 31 (D) mm
- Vikt:** 190 g (inklusive batterier)

## Extrafjärrkontrollen (RC-1070)

- Batterier:** Typ R03/AAA (två batterier)
- Största yttermått:** 49 (B) x 220 (H) x 24,5 (D) mm
- Vikt:** 114 g (inklusive batterier)

\* : Wi-Fi®-konformitet garanterar och bevisar kompatibilitet med "Wi-Fi Alliance", som är grupp som certifierar gemensam anpassning av och funktion hos olika trådlösa nätverksenheter.

※ Rätt till ändringar förbehålles i produktförbättringssyfte.

List of preset codes / Liste von voreingestellten Codes / Liste de codes pré-réglés / Lista dei codici pre-regolati /  
 Lista de códigos pre-ajustados / Lijst van voorinstelde codes / Förteckning över förinställda koder

Denon Amp	
D Denon	81001, 82001, 83001, 84001

Denon Tuner	
D Denon (Analog)	52863, 52795, 52800, 52805

Denon Digital Tuner	
D Denon (NET)	62865, 62837, 62838, 62839

Denon iPod	
D Denon	72815, 72816, 72817, 72818

Cable	
-------	--

<b>A</b> A-Mark	00008, 00144
ABC	00237, 00003, 00008
Accuphase	00003
Acorn	00237
Action	00237
Active	00237
ADB	01230
Aichi Denshi	01512
Americast	00899
Amstrad	01222
Archer	00237
Auna	01230
Austar	00276
<b>B</b> BCC	00276
Bell South	00899
Bestlink	00303
Birmingham Cable Communications	00276
British Telecom	00003
<b>C</b> Cable & Wireless	01068
Century	00008
Coship	01462
<b>D</b> Daehan	00778
Daeryung	01877, 00877, 00477, 00008
Digeo	01187
Director	00476
DX Antenna	01500
<b>E</b> Emerson	00303
Encon	00008
<b>F</b> Fosgate	00276
Foxtel	01222
France Telecom	00817
Freebox	01482
Fujitsu	01497

<b>G</b> Galaxi	00008
GE	00237, 00144
Gehua	00476
General Instrument	00476, 00810, 00276, 00003
Gibraltar	00003
GNI	01466
GoldStar	00144
<b>H</b> Hitachi	00003, 00008
Hongtian Jiangsu	01462
Hwalin	00303
<b>I</b> Insight	00476, 00810
<b>J</b> Jerrold	00476, 00810, 00276, 00003
Jiuzhou	01445
<b>K</b> KNC	00008
<b>L</b> LG	00144
<b>M</b> Macab	00817
Madritel	01230
Maspro	01510
Matav	01082
Memorex	00000
Mitsubishi	00003
Motorola	01376, 00476, 00810, 00276, 01187
MS	00303
<b>N</b> NEC	01496
Noos	00817
Nova Vision	00008
Novaplex	00008
NTL	00276, 00003, 01060, 01068
<b>O</b> Oak	00303
Ono	01068
Optus	00276, 01060
<b>P</b> Pace	01877, 00877, 00237, 00008, 01060, 01068, 01577
Panasonic	00000, 00008, 00144, 01488
Paragon	00000, 00008, 00525
Penney	00000
Philips	01305, 00317, 00817
Pioneer	01877, 00877, 00144, 00533, 01500
Pulsar	00000
PVP Stereo Visual Matrix	00003
<b>Q</b> Quasar	00000
<b>R</b> RadioShack	00303
Regal	00276
Runco	00000
<b>S</b> Sagem	00817
Salora	00000
Samsung	00003, 00000, 00144, 00778, 00840, 01060, 01666
Scientific Atlanta	01877, 00877, 00477, 00237, 00003, 00000, 00008, 01510

Skyworth	01464
Sony	01006, 01460
Sprucer	00144
Starcom	00003
StarHub	00276
Sumitomo	01500, 01504
Supercable	00276
<b>T</b> Taihan	00778
TCL	01445
Telewest	01068
Time Warner cable	01877
TongKook	00840
Torx	00003
Toshiba	00000, 01509
Trans PX	00276, 00303
TS	00003, 00303
<b>U</b> United Cable	00276, 00003
US Electronics	00276, 00003, 00008
<b>V</b> Videoway	00000
Visiopass	00817
<b>Z</b> Zenith	00000, 00525, 00899

Cable/PVR Combination ※1

<b>A</b> Americast	00899
<b>D</b> Digeo	01187
<b>F</b> Freebox	01482
<b>G</b> General Instrument	00810
<b>J</b> Jerrold	00810
<b>M</b> Motorola	01376, 00810, 01187
<b>P</b> Pace	01877, 00237
Pioneer	01877, 00877
<b>S</b> Scientific Atlanta	01877, 00877
Sony	01006
Supercable	00276
<b>T</b> Time Warner cable	01877
<b>Z</b> Zenith	00899

CD Player

<b>A</b> Acoustic Research	40420
Advantage	40032
Aiwa	40157
Arcam	40157
Audio Research	40157
Audiolab	40157
Audiomeca	40157
Audioton	40157
AVI	40157
<b>B</b> Balanced Audio Technology	40157

Burmester	40420
Bush	40388
<b>C</b> Cairn	40157
California Audio Labs	40029, 40303
Cambridge	40157
Cambridge Audio	40157
Cambridge Soundworks	40157
Carver	40157, 40179
CDC	40420
CEC	40420
Copland	40393
Curtis Mathes	40032
Cyrus	40157
<b>D</b> Denon	40873, 40003, 40766, [42867] *, 42868
DKK	40000
DMX Electronics	40157
Dual	40003
Dynaco	40157
Dynamic Bass	40179
<b>F</b> Fisher	40000, 40179
<b>G</b> Garrard	40393, 40420
Genexxa	40000, 40032, 40037, 40179
Goldmund	40157
Grundig	40157
<b>H</b> Hafler	40173
Harman/Kardon	40100, 40157, 40173
Hitachi	40032
<b>I</b> Inkel	40157
Integra	40101
<b>J</b> Jerrold	40003
JVC	40032, 40072
<b>K</b> Kenwood	40681, 40000, 40029, 40157, 40028, 40037, 40036, 40190
KLH	41318
Krell	40157
<b>L</b> Linn	40157
Loewe	40157
Luxman	40393
LXI	40179
<b>M</b> Magnavox	40157
Marantz	40029, 40157
Matsui	40157
MCS	40029
Memorex	40000, 40032, 40179, 40420, 40468
Meridian	40157
Micromega	40157
Miro	40000
Mission	40157

Modulaire	40000, 40032, 40087, 40179, 40420, 40468
MTC	40420
Musical Fidelity	40393
Myryad	40157
<b>N</b> NAD	40000, 40721
Naim	40157
NSM	40157
<b>O</b> Onkyo	40868, 40101
Optimus	40000, 40032, 40037, 40087, 40179, 40393, 40420, 40468
Orion	40393
<b>P</b> Panasonic	40029, 40303, 40388, 40752
Parasound	40420
Penney	40029
Philips	40157
Pioneer	40032, 40101, 40468
Polk Audio	40157
Proceed	40420
QED	40157
<b>Q</b> Quad	40157
Quasar	40029
<b>R</b> Radiola	40157
RadioShack	40000, 40032, 40179, 40420, 40468
RCA	40032, 40053, 40179, 40420, 40468
Realistic	40000, 40032, 40087, 40179, 40420, 40468
Restek	40157
Revox	40157
Roksan	40420
Rotel	40157, 40420
Royal	40420
<b>S</b> SAE	40157
Saisho	40000
Sansui	40000, 40157
Sanyo	40000, 40087, 40179
SAST	40157
Sears	40179
Sharp	40037
Siemens	40157
Silsonic	40036
Simaudio	40157
Sonic Frontiers	40157
Sony	40490, 40000, 40100, 41364, 40185
Sugden	40157
Sylvania	40157
<b>T</b> TAG McLaren	40157
Tandy	40032

Tascam	40393, 40420
Teac	40490, 40393, 40420
Technics	40029, 40303
Techwood	40303
Thomson	40053
Thorens	40157
Thule Audio	40157
Tokai	40420
<b>U</b> Universum	40157, 40053
<b>V</b> Victor	40072
<b>W</b> Wadia	40393
Wards	40000, 40032, 40157, 40053, 40087, 40179
<b>Y</b> Yamaha	40490, 40868, 40032, 40036
Yorx	40000

## CD Recorder

<b>D</b> Denon	40766, 42868
<b>J</b> JVC	40072
<b>R</b> RCA	40053, 40420
<b>S</b> Sony	40000, 40100, 41364
<b>T</b> Teac	40420
Thomson	40053

## Tape Deck

<b>A</b> Aiwa	20029, 20197, 20200, 21315
Akai	20283, 20439
Arcam	20076
Audiolab	20029
<b>C</b> Carver	20029
<b>D</b> Denon	20076, 20371, 21311, [22471]*
<b>F</b> Fisher	20074
<b>G</b> Garrard	20308, 20309, 20375, 20439
Genexxa	20439
GoldStar	20375
Grundig	20029, 20375
<b>H</b> Harman/Kardon	20182, 20029, 21314
<b>I</b> Inkel	20070, 20071, 20337
<b>J</b> JVC	20244, 20273, 20274, 20303, 20304, 20310, 21309
<b>K</b> Kenwood	20070, 20071, 20092, 20233, 20234, 21364
<b>L</b> LG	20375
Luxman	20308, 20309
<b>M</b> Magnavox	20029
Marantz	20029, 20009
Memorex	20099
Mitsubishi	20283, 20439
Myryad	20029
<b>O</b> Onkyo	20135, 20136, 20282
Optimus	20027, 20220, 20337, 20439

Orion	20308, 20309
<b>P</b> Palladium	20375
Panasonic	20229
Philips	20029, 20229
Phonotrend	20337
Pioneer	20027, 20220, 20099, 20109, 21306, 21312
Polk Audio	20029
<b>R</b> Radiola	20029
RCA	20027, 20220
Revox	20029
<b>S</b> Sansui	20029, 20009
Sanyo	20074
Sharp	20231, 20371
Sherwood	20337
Sonic	20375
Sony	20243, 20170, 20291, 20234, 21313
<b>T</b> TaeKwang	20439
Tandberg	20109
Teac	20280, 20283, 20289, 20308, 20309
Technics	20229
Technovox	20229
Thorens	20029
<b>U</b> Universum	20375, 20439
<b>V</b> Victor	20244, 20273, 20274
<b>W</b> Wards	20027, 20029
Wharfedale	20439
<b>Y</b> Yamaha	20097, 20094

## HDTV Tuner ※1

<b>A</b> ABS	01272
Accurian	01653
Alienware	01272
<b>C</b> CyberPower	01272
<b>D</b> D-Link	01554
Dgtec	01363
<b>E</b> Epson	01563
<b>G</b> Gateway	01272
<b>H</b> Hewlett Packard	01272, 01267
Howard Computers	01272
HP	01272, 01267
Hush	01272
<b>I</b> iBUYPOWER	01272
<b>L</b> LG	01415
Linksys	01272, 01365
<b>M</b> Media Center PC	01272
Microsoft	01272, 01805
Mind	01272
Motorola	01363
<b>N</b> Niveus Media	01272

Northgate	01272
<b>P</b> Packard Bell	01272
Panasonic	01120
Pioneer	01010
<b>R</b> Ricavision	01272
<b>S</b> Samsung	01190, 01490
Sensory Science	01126
Sharp	01010
SMC	01456
Sony	01272, 01324, 01364
Stack 9	01272
Sylvania	01563
Systemax	01272
<b>T</b> Tagar Systems	01272
Toshiba	01272
Touch	01272
<b>V</b> Viewsonic	01272, 01329
Vizio	01126
Voodoo	01272
<b>X</b> Xbox	01805
<b>Z</b> ZT Group	01272

## Satellite Receiver

<b>A</b> @sat	01300
@Sky	01334
A-Mark	00345
ABsat	00123, 00713
ADB	00642, 01259, 01367, 01418, 01473, 01491
AGS	00710
Aiwa	01514
Akai	00200
Alba	00455, 00713, 01284, 01659, 01811
Allsat	00200, 01043
Alltech	00713
Allvision	01232, 01334, 01412
AlphaStar	00772
Amitronica	00713
Amstrad	00345, 00713, 00795, 00847, 00863, 00882, 01113, 01175, 01693, 01801
Anglo	00713
Ankaro	00713
AntSat	01083
Apollo	00455
Arcon	01043, 01075
Armstrong	00200
Arnion	01300
Asat	00200
ASCII	01334
ASLF	00713
AssCom	00853

Astacom	00710
Aston	00142
Astra	00713
Astratec	01743
Astro	00173, 00658, 01099, 01100, 01113
Atlantic Telephone	01333
Atsat	01300
AtSky	01334
Audioline	01672
Aurora	00642, 00879, 01333, 01433
Austar	00497, 00642, 00863, 00879, 01176, 01259
Axiel	00710
Axil	01457, 01659
Axis	01111
<b>B</b> B@ytronic	01412
Beko	00455
Bell ExpressVu	00775
Big Sat	01457
Black Diamond	01284
Blaupunkt	00173
Blue Sky	00713
Boca	00713, 01232, 01366
Boston	00710, 01251
Brainwave	00658, 01672
British Sky Broadcasting	00847, 01175, 01662, 01847
Broco	00713
BskyB	00847, 01175, 01662
BT	00710, 01296
Bubu Sat	00713
Bush	01284, 01645, 01672, 01743, 01811
<b>C</b> Canal	00853
Canal Digital	00853, 01622
Canal Satellite	00853, 01339, 01853
Canal+	00853
Centrex	01457
CGV	01413, 01567
Chaparral	00216
Cherokee	00123, 00710
Chess	00713, 01085, 01334, 01626
Chili	01718
CityCom	00299, 00394, 00818, 01075, 01176, 01232
Classic	01672
Clatronic	01413
CNS	01367
Comag	01232, 01366, 01412, 01413
Condor	01700
Conia	01695
Contec	00394
Continental Edison	01695

Coship	01457
Crossdigital	01109
Crown	01284
Cryptovision	00455, 00795
Cyfra+	01076
Cyrus	00200
<b>D</b> D-box	00723, 00873, 01114
Daewoo	00713, 01111, 01296, 01743
Delfa	00863
Deltasat	01075
Dgtec	01542, 01631, 01242
Digenius	00299
Digitality	01685
Digifusion	01645, 01743
DigiLogic	01284
DigiQuest	00863, 01300, 01457, 01473
DigiSat	01232
Digisky	01457
DigitAll World	01227
Digiturk	01076
Digiwave	01631
Dijam	01296
DiPro	01367, 01543
DirecTV	01377, 00392, 00566, 00639, 01639, 01142, 00247, 00749, 01749, 00724, 00819, 01856, 01076, 01108, 00099, 01109, 01414, 01442, 01609, 01392, 01640
Discovery	00710
Dish Network System	01505, 01005, 00775, 01775
Dishpro	01505, 01005, 00775, 01775
Distratel	01283, 01704
DMT	01075
DNT	00200
Dream Multimedia	01237
DSE	01375
DSTV	00642, 00879, 01433
Durabrand	01284
DX Antenna	01530
Echostar	01505, 01005, 00775, 00455, 00610, 00713, 00853, 00871, 01086, 01200, 01323, 01409, 01418, 01473, 01775
Einhell	00713
Elap	00713, 01567
Elsat	00713
Elta	00200, 01659
Emme Esse	00871
Energy Sistem	01631
Engel	00713, 01251
EP Sat	00455
Esat	00879
Eurieult	00882

Eurocrypt	00455
EuroLine	01251
Europa	00863
Europhon	00299
Eurosky	00262, 00299
Eurostar	00818
Eutelsat	00713
Expressvu	00775, 01775
<b>F</b> Fenner	00713
Ferguson	00455, 01291, 01743
Finlandia	00455
Finlux	00455
Flair Mate	00713
FMD	01251, 01413, 01457
Force	01101
Fortec Star	01083
Foxtel	00455, 00497, 00795, 00879, 01162, 01176, 01356
Fracapro Planet	00871
Fracarro	00125, 00871
France Telecom	00871
Freesat	00882
FTE	00863
FTEmaximal	00713, 00863
Fuba	00173, 00262, 00299, 00394, 01214, 01251, 01801
Fugionkyo	00125
Funai	01377
<b>G</b> Galaxis	00853, 00863, 01101, 01111, 01557
Gardiner	00818
Garnet	01075
GbSAT	01214
GE	00392, 00566
Gecco	01412
General Instrument	00869
General Satellite	01176
GF Good Friends	01043
GF Star	01043
Globo	01251, 01334, 01412, 01429, 01626
GOD Digital	00200
GOI	00775, 01775
Gold Box	00853
Gold Vision	01631
Golden Interstar	01283
GoldStar	00394
Goodmans	00455, 01284, 01291
Gradiente	00887
Granada	00455
Grundig	00173, 00345, 00847, 00853, 00879, 01291
<b>H</b> Handan	01622
Hanseatic	01099, 01100

Hauptpage	01672
HB	01214, 01801
HDT	01159
Hills	01232
Hirschmann	00125, 00173, 00299, 00710, 00882, 01085, 01111, 01232, 01412
Hisense	01535
Hitachi	00749, 00819, 00455, 01250, 01284, 01518, 01523, 01525
Homecast	01214, 01680, 01700
Hornet	01300
Houston	00775
HTS	00775, 01775
Hughes Network Systems	01142, 00749, 01749, 01442
Humax	00863, 01176, 01225, 01406, 01427, 01675, 01743, 01790, 01915
Huth	01075
Hyundai	01075, 01159
<b>I</b> iCan	01367
ID Digital	01176
ILLUSION sat	01557, 01631
iLo	01535
Imperial	01334, 01429, 01672
Indovision	00887
Ingelen	00882
Innova	00099
Interstar	01214
InVideo	00871
ISkyB	00887
Italtel	00871
ITT Nokia	00455, 00723, 00873
<b>J</b> Jadeworld	00642
Jaeger	01334
Jerrold	00869
Jiuzhou	01450
JOK	00710
JVC	00775, 01507, 01531, 01775
<b>K</b> K-SAT	00713
Kamm	00713
Kaon	01300
KaTelco	01111
Kathrein	00123, 00173, 00200, 00249, 00394, 00442, 00480, 00504, 00658, 00713, 00818, 01221, 01416, 01561, 01567
Kennex	00125
Kenwood	00853
Klap	00710
Kocmoc TB	01333
Koscom	01043
Kosmos	00442, 01333
Kreiling	00249, 00658

Kreismeyer	00173
Kross	01695
<b>L</b> L&S Electronic	01043, 01334
Labgear	01296
LaSAT	00173, 00299
Lava	01631
Legend	01718
Legrand	01718
Lemon	01334
Lenco	00713
Lennox	01611
LG	01075, 01414
Lifesat	00299, 00713, 01043
Lodos	01284
Logik	01284
Logix	01075
Lorenzen	00299
Luxor	00345, 00873
<b>M</b> M Electronic	00818
M vision	01557
Magnavox	00724, 00722
Manata	00710, 00713
Manhattan	00455, 00710, 01083
Marantz	00200
Maspro	00173, 00713, 01530
Master's	00394
Matsui	00173, 00710, 01284, 01743
Maximum	01075, 01334, 01685
McIntosh	00869
MDS	01225
Mediabox	00853
Mediacom	01206
MediaSa	00853
Medion	00299, 00713, 01043, 01075, 01232, 01334, 01412, 01626
Medison	00713
Mega	00200
Memorex	00724
Metronic	00713, 00818, 01283, 01334, 01375, 01704
Metz	00173
MiCO	01811
Micro	00713
Micro Elektronik	00713
Micro Technology	00713
Micromaxx	00299
Microstar	01075
Microtec	00713
Mitsubishi	00749, 00455
Morgan's	00200, 00713, 01232, 01412
Motorola	00869, 00856, 01473
MTEC	01214
Muller	01695

Multibroadcast	00642, 00879
Multichoice	00642, 00879, 01333, 01433, 01559, 01560
Mx Onda	01659
Myriad	00200
Mysat	00713
MySky	01693, 01848, 01850
<b>N</b> NEC	01519
NEOTION	01334
Netgem	01322
Netsat	00099, 00887
Neuf TV	01322
Neuhaus	00713
Neuling	01232
Neusat	00713
Nevir	01659
Next Level	00869
Nikko	00200, 00713, 00723
Noda Electronic	01704
Nokia	00455, 00723, 00751, 00853, 00873, 01023, 01223, 01723
Nordmende	00455, 01611
<b>O</b> OctalTV	01505
Okano	00442
Omega	00887
Opentel	01232, 01412
Optex	00394, 00713, 01043, 01283, 01611
Optimus	00724
Optus	00879
Orbis	01232, 01334, 01412
Orbitech	01099, 01100
Origo	00497
OSAT	00345
<b>P</b> P/Sat	01232
Pace	00200, 00329, 00455, 00497, 00795, 00847, 00853, 00887, 01175, 01323, 01356, 01423, 01693, 01717, 01848, 01850
Pacific	01284, 01375
Packard Bell	01111
Packsat	00710
Palcom	00299, 01409
Panarex	01159
Panasat	00615, 00879, 01333, 01433
Panasonic	00247, 00701, 00455, 00847, 01304, 01404, 01508, 01526, 01527
Panda	00173, 00455
Pansat	01159
Patriot	00710
Paysat	00724
peekTon	01457

Philips	01142, 00749, 01749, 00775, 00724, 00819, 01076, 00722, 00099, 00710, 00455, 00818, 00200, 00847, 00853, 00173, 01114, 00133, 01442, 01543, 01672
Phonotrend	00863, 01200
Pilotime	01339
Pino	01334
Pioneer	01142, 00329, 00853, 01308, 01442
Planet	00871
Plasmatic	00442
Neuf TV	00713, 01611
Polytron	00394
Portland	01296
Preisner	00262, 01101, 01113, 01366
Premier	00723, 00853, 00873, 01429
Prima	00795
Primacom	01111
Primestar	00869
Profile	00710
Promax	00455
Proscan	00392, 00566
Proton	01535
<b>Q</b> QNS	01367, 01402, 01404
Quadral	00710
Quelle	00299
<b>R</b> Radiola	00200
RadioShack	00566, 00775, 00869
Radix	00394, 00882, 01113, 01317
RCA	00392, 00566, 01142, 00775, 00855, 00143, 01291, 01392, 01442
Rebox	01214
Regal	01251
RFT	00200
Roadstar	00713, 00853
Rollmaster	01413
Rover	00713
Rownsonic	01567
<b>S</b> SAB	01251
Saba	00710, 00820
Sabre	00455
Sagem	00820, 01114, 01253, 01307, 01690
Samsung	01377, 01142, 01276, 01108, 01109, 00853, 00863, 01206, 01442, 01458, 01570, 01609, 01700, 01916
Sat Control	01300
Sat Team	00713
SAT+	01409
Satec	00713
Satelco	01232
Satplus	01100

Satstation	01083
Schaub Lorenz	01214
Schneider	00710, 01206, 01251
Schwaiger	00394, 00504, 00863, 01075, 01083, 01111, 01317, 01334, 01412, 01457
SCS	00299
Sedea Electronique	00125, 01206, 01283, 01626
SEG	01075, 01087, 01251, 01626
Seleco	00871
Septimo	01375
Serd	01412
Serino	00610
Servimat	01611
ServiSat	00713, 01251
Sharp	01517
Siemens	00173, 01334, 01429
Silva	00299
Skantin	00713
SKR	00713
SKY	00856, 00099, 00847, 00887, 01014, 01175, 01662, 01693, 01847, 01848, 01850
SKY Italia	00853, 01693, 01847, 01848
Sky Television	01014
Sky XL	01251, 01412
Sky+	01175
Skymaster	00713, 01075, 01085, 01200, 01334, 01409, 01567, 01611
Skymax	00200
Skyplus	01232, 01334, 01412
SkySat	00713
Skyvision	01334
SL	00299, 01672
SM Electronic	00713, 01200, 01409
Smart	00713, 00882, 01101, 01113, 01232, 01404, 01413
Sony	00639, 01639, 00455, 00847, 00853, 01524, 01558, 01640
Star	00887
Star Choice	00869
Star Trak	00772, 00869
Starland	00713
Starlite	00200
Stream	01847, 01848
Strong	00125, 00713, 00820, 00853, 00879, 01159, 01284, 01300, 01409, 01626
Sunkai	00123
Sunny	01300
Sunsat	00713
Sunstar	00642
Supernova	00887
SVA	01455
Systec	01334

<b>T</b> Tantec	00455
Tarbs	01225
Tatung	00455
TBoston	01659
Teac	01225, 01227, 01251, 01322
Tecatel	01200
TechniSat	00262, 00455, 00863, 01099, 01100, 01195, 01197, 01322
Technomate	01283, 01610
Technosonic	01672
Technotrend	01429
Techwood	01284, 01626
Tele System Electronic	01251, 01409, 01611, 01801
Teleciel	01043
TeleClub	01367
Telefunken	00710
Teleka	00262, 00442
Telestar	01099, 01100, 01251, 01334, 01610, 01626
Telesystem	01801
Televés	00455, 01214, 01300, 01334
Televisa	00887
Telewire	01232
Tevion	00713, 01409, 01622, 01672
Thomson	00392, 00566, 00455, 00710, 00713, 00820, 00847, 00853, 01046, 01175, 01291, 01534, 01543, 01662
Thorn	00455
Tiny	01672
Tioko	00394
Tivo	01142, 01442
Tokai	00200
Tonna	00455, 00713, 01611
Topfield	01206, 01208, 01545, 01783
Toshiba	00749, 01749, 00790, 00819, 00455, 01285, 01501, 01516, 01530
TPS	00820, 01253, 01307
Triax	00200, 00713, 00853, 01113, 01227, 01251, 01291, 01296, 01626
Trio	01075
TT-micro	01429
Turnsat	00713
Twiner	00713, 01611
<b>U</b> UEC	00879, 01162, 01333, 01356
UltimateTV	01392, 01640
Uniden	00724, 00722
Unisat	00200
United	01251
Universum	00173, 00299, 01087, 01099, 01251
US Digital	01535
USDTV	01535

<b>V</b> Variosat	00173
Ventana	00200
Vestel	01251
VH Sat	00299
Viasat	01682
ViewSat	01232
Visionic	00125, 01283
VisionNet	01557
Visiosat	00142, 00710, 00713, 01413, 01457, 01718
Viva	00856
Vivid	01162
Voom	00869
VTech	00818
<b>W</b> Wavelength	01232, 01413
Wewa	00455
Wharfedale	01284
Winbox	01801
Wintel	00299
Wisi	00173, 00299, 00455
Worldsat	00123, 00710, 01214, 01251, 01543
<b>X</b> Xcom	00123
XMS	01075
Xsat	00123, 00713, 00847, 01214, 01323
Xtreme	01300
<b>Y</b> Yakumo	01413
Yamada	01718
Yes	00887
Zehnder	00394, 00504, 00818, 01075, 01232, 01251, 01334, 01412, 01413
Zenith	00856, 01856
Zeta Technology	00200
Zodiac	01801

### Satellite Receiver/ PVR Combination ※1, ※3

※1	
<b>A</b> @sat	01300
Allvision	01412
Amstrad	01175
Atsat	01300
<b>B</b> B@ytronic	01412
British Sky Broadcasting	01175
BskyB	01175, 01662
Bush	01645
<b>C</b> Canal Satellite	01339
Comag	01412
<b>D</b> Digi fusion	01645
DigiQuest	01300
Digiturk	01076

DirecTV	01377, 00392, 00639, 01142, 01076, 00099, 01392, 01442, 01640
Dish Network System	01505, 00775
Dishpro	01505, 00775
DMT	01075
Dream Multimedia	01237
<b>E</b> EchoStar	01505, 00775, 00610
Expressvu	00775
<b>F</b> Foxtel	01356
<b>G</b> GbSAT	01214
Gecco	01412
Globo	01412
<b>H</b> HDT	01159
Hirschmann	01412
Homecast	01680
Hughes Network Systems	01142, 01442
Humax	01176, 01427, 01675
Huth	01075
Hyundai	01075, 01159
<b>K</b> Kaon	01300
Kathrein	00249, 00658, 01221, 01561
<b>L</b> LG	01075
<b>M</b> Maximum	01334
Mediacom	01206
Medion	01412
Microstar	01075
Morgan's	01412
Motorola	00869
MTEC	01214
Multichoice	01333, 01559, 01560
MySky	01693, 01848, 01850
<b>N</b> NEOTION	01334
Nokia	01023
<b>O</b> Opentel	01412
Orbis	01412
<b>P</b> Pace	01175, 01356, 01423, 01850
Panasonic	01304
Philips	01142, 00099, 01442
Pilotime	01339
Proscan	00392
<b>R</b> Radix	01317
RCA	01392
Rebox	01214
<b>S</b> Sagem	01253, 01307
Samsung	01206, 01442, 01570, 01609
Sat Control	01300
Schneider	01206
Schwaiger	01075, 01412
Sedea Electronique	01206
Serd	01412
SKY	01175, 01693, 01848, 01850

SKY Italia	01848
Sky XL	01412
Skymaster	01075
Skyplus	01412
Sony	00639, 01640
Star Choice	00869
Strong	01300
Sunny	01300
<b>T</b> TechniSat	01195, 01197
Thomson	01175, 01534, 01662
Topfield	01206, 01545, 01783
TPS	01253, 01307
<b>X</b> Xtreme	01300
<b>Z</b> Zehnder	01075, 01412

### ※3

<b>H</b> Hughes Network Systems	20739
<b>P</b> Philips	20739
<b>S</b> Samsung	20739

### Television

<b>1</b> 888	10264
<b>A</b> A-Mark	10047, 10054, 10009
A.R. Systems	10037, 10352, 10374, 10455, 10556
Accent	10009, 10037
Accuscan	10047
Accuscreen	10001
Acoustic Research	11269
Action	10030, 10650
Acura	10009
Addison	10092, 10108, 10653
ADL	11217
Admiral	10047, 10054, 10017, 10051, 10093, 10463, 10180, 10163, 10264, 10418
Advent	10761, 10783, 10815, 10817, 10842, 10876, 11933
Adventuri	10000
Adyson	10217
AEG	11163, 11556
Agashi	10217, 10264
Agna	10150
Aiko	10092, 10009, 10035, 10037, 10217, 10264, 10361, 10371, 10433
Aim	10706, 10037, 10455, 10805
Aiwa	10264, 10701, 11904, 11911
Akai	10000, 10060, 10812, 10702, 10178, 10030, 10145, 10602, 10606, 10631, 10648, 10672, 10714, 10715, 11207, 11537, 11675, 11676, 11903, 10556, 10548, 10480, 10433, 10371, 10361, 10264, 10218, 10217, 10208, 10163, 10037, 10035, 10009

Akashi	10009, 10860
Akiba	10037, 10218, 10455
Akira	10418
Akito	10037
Akura	10171, 10009, 10037, 10163, 10218, 10264, 10668, 10714, 11037, 11498, 11556, 11982
Alaron	10170
Alba	10009, 10036, 10037, 10073, 10163, 10218, 10352, 10370, 10371, 10418, 10443, 10487, 10668, 10714, 11037
Albatron	10700, 10843
Alfide	10672
All-Tel	10865, 11269
Alleron	10030, 10170
Allorgan	10217
Allstar	10037
Ambassador	10150
America Action	10180
American High	10000, 10060
Amplivision	10217, 10370
Amstrad	10000, 10171, 10009, 10011, 10037, 10163, 10218, 10264, 10362, 10371, 10433, 10648, 11037, 11982
Amtron	10000, 10180
Anam	10250, 10180, 10009, 10037, 10700, 10861
Anam National	10250, 10037, 10650
Andersson	11149, 11163
Anglo	10009, 10264
Anhua	10051
Anitech	10009, 10037, 10264
Ansonic	10009, 10037, 10163, 10370, 10374, 10668
AOC	10451, 10093, 10180, 10060, 10178, 10030, 10092, 10009, 10108
Aolinpike	10264
Apex Digital	10156, 10748, 10879, 10765, 10767, 11217, 11943
AR	10352, 10556
Arc En Ciel	10109
Arcam	10217
Ardem	10037, 10714
Aristocrat	10163
Aristona	10037, 10556
ART	11037
Arthur Martin	10163
ASA	10070
Asberg	10037
Asora	10009
Astra	10037
Asuka	10217, 10218, 10264
ATD	10698
Atlantic	10001, 10037

Atori	10009
Auchan	10163
Audinac	10180
Audiosonic	10009, 10037, 10109, 10217, 10218, 10264, 10370, 10374, 10486, 10714, 10715, 10820
Audioton	10217, 10264, 10370, 10486
Audiovox	10451, 10180, 10092, 10623, 10802, 10875, 11937, 11951, 11952
Audioworld	10698
Aumark	10060
Autovox	10217
Aventura	10171
AVP	10000
Awa	10451, 10009, 10011, 10036, 10108, 10217, 10264, 10374, 10606
Axion	11937, 11958
Axxent	10009
Baier	10876
Baihe	10009, 10264
Baile	10001, 10009, 10374, 10661
Baird	10037, 10073, 10109, 10208, 10217, 10343, 11196
Bang & Olufsen	10565
Baohuashi	10264
Baosheng	10009, 10817
Barco	10163, 10556
Basic Line	10009, 10037, 10163, 10217, 10218, 10374, 10455, 10556, 10668, 11037, 11163
Bastide	10217
Bauer	10805
Baur	10037, 10195, 10361, 10455, 10512
Baysonic	10180
Bazin	10217
Beaumarck	10017, 10178, 10030
Beijing	10812, 10001, 10009, 10208, 10226, 10264, 10374, 10661, 10817, 10821
Beko	10037, 10195, 10370, 10418, 10486, 10606, 10714, 10715, 10808, 11037
Belcor	10030
Bell & Howell	10054, 10017, 10154, 10093
Belson	10698, 11191
Belstar	11037
BenQ	11032, 11756
Beon	10037, 10163, 10218, 10418
Berthen	10668
Best	10370
Bestar	10037, 10370, 10374
Bestar-Daewoo	10374
Binatone	10217
Black Diamond	10614, 10820, 10821, 11037, 11163, 11909

Blackway	10218
Blaupunkt	10036, 10170, 10195, 10200, 10327, 10455
Blue Sky	10037, 10218, 10455, 10487, 10499, 10556, 10668, 10714, 10715, 11037, 11191, 11363
Boots	10009, 10217
BPL	10037, 10208
Bradford	10180
Brandt	10109, 10287, 10335, 10560, 10625, 10714
Brinkmann	10037, 10418, 10486, 10668
Brionvega	10037, 10362
Britannia	10217
Brockwood	10178, 10030
Broksonic	10236, 10463, 10180, 11911, 11938
Brother	10264
BSR	10163
BTC	10218
Bush	11900, 11556, 11037, 10778, 10714, 10698, 10668, 10661, 10614, 10556, 10487, 10374, 10371, 10361, 10335, 10264, 10218, 10217, 10208, 10163, 10037, 10036, 10009
Caihong	10009, 10817
Cailing	10748
Candle	10030
Canton	10218
Capehart	10017, 10178, 10030, 10092, 10036
Capetronic	10030
Capsonic	10264
Carad	10610, 10668, 11037
Carena	10037, 10455
Carnivale	10030
Carrefour	10036, 10037, 10070
Carver	10054, 10170
Cascade	10009, 10037
Casio	10037
Cathay	10037, 10218
CCE	10037, 10217
Celebrity	10000
Celera	10765
Celestial	10767, 10819, 10820, 10821
Centrex	10780
Centrum	11037
Centurion	10037
CGE	10074, 10163, 10370, 10418
Changcheng	10051, 10001, 10009, 10264, 10374, 10661, 10817
Changfei	10009, 10374, 10817
Changfeng	10264, 10817
Changhai	10009, 10817

Changhong	10156, 10765, 10009, 10264, 10508, 10767, 10783, 10817, 10819, 10820, 10821, 11008, 11156
Chengdu	10009, 10817
Ching Tai	10092, 10009
Chun Yun	10000, 10180, 10092, 10009, 10700, 10843
Chunfeng	10009, 10264
Chung Hsin	10180, 10053, 10036, 10108
Chunsun	10009, 10817
Cimline	10009, 10218
Cinema	10672
Cineral	10451, 10092
Cinex	10648, 11556
Citek	10047
Citizen	10054, 10000, 10451, 10463, 10180, 10060, 10030, 10171, 10092, 10001, 10035
City	10009
Clarion	10180
Clarivox	10037, 10070, 10418
Classic	10030, 10092, 10499
Clatronic	10009, 10037, 10217, 10218, 10264, 10370, 10371, 10714
Clayton	11037
CMS Hightec	10217
Colortyme	10047, 10054, 10017, 10060, 10178, 10030
Commercial Solutions	11447, 10047
Concorde	10009
Condor	10009, 10037, 10264, 10370, 10418
Conia	10820, 10821, 11498
Conic	10178
Conrac	10808
Conrowa	10156, 10145, 10009, 10264, 10698, 11156, 11170
Contec	10180, 10009, 10036, 10037
Continental Edison	10109, 10287, 10487
Cosmel	10009, 10037
Craig	10180, 10171
Crosley	10054, 10000, 10180, 10030, 10171, 10074, 10163, 10370, 10093, 10180, 10053, 10009, 10037, 10208, 10370, 10418, 10486, 10487, 10606, 10672, 10712, 10714, 10715, 11037
Crown	
Crown Mustang	10672
CS Electronics	10218
CTX	11756
Curtis Mathes	10047, 10054, 10154, 10000, 10051, 10451, 10093, 10180, 10060, 10702, 10178, 10030, 10145, 10166, 10037, 10035, 11147, 11347
CXC	10180
Cybertron	10218
Cytronix	11298
D-Vision	10037, 10556, 11982

Daewoo	10154, 10451, 10180, 10178, 10030, 10092, 11661, 10634, 10661, 10672, 10700, 10860, 10865, 10876, 10880, 11755, 11756, 11909, 10623, 10556, 10499, 10374, 10264, 10218, 10217, 10170, 10109, 10108, 10037, 10036, 10009
Dainichi	10218
Dansai	10009, 10035, 10036, 10037, 10208, 10217
Dantax	10370, 10486, 10714, 10715
Datsura	10208
Dawa	10009, 10037
Daytek	10672, 11207
Dayton	10092, 10009, 11207
Daytron	10180, 10178, 10030, 10092, 10009, 10036, 10037, 10374
Dayu	10374, 10661
De Graaf	10163, 10208, 10548
Decca	10037, 10217
Degraff	10163, 10208
Deitron	10374
Dell	11080, 11178
Denko	10264
Denon	10145, 10511
Denver	10037, 10587
Desmet	10009, 10037
Diamant	10037
Diamond	10706, 10009, 10371, 10672, 10698, 10820, 10860
Digatron	10037
Digiline	10037, 10668
Digital Life	10872
Digitex	10820
Digitor	10037
Digix Media	10880
Dixi	10009, 10037, 10217
DL	10587, 10780, 10872
Domeos	10668
Domland	10394
Dongda	10009
Donghai	10009
Dream Vision	11164, 11704
DSE	10698, 10820, 11556
DTS	10009
Dual	10037, 10217, 10343, 10352, 10394, 11037, 11137
Dual Tec	10217
Dumont	10017, 10180, 10178, 10070, 10217
Durabrand	10463, 10180, 10178, 10171, 11034, 11463
Dux	10037
Dwin	10093
Dynatech	10217
Dynatron	10037

**D** D-Vision 10037, 10556, 11982

<b>E</b>	Easy Living	11248
	Eaton	10060
	Ecco	10773
	ECE	10037
	Edison-Minerva	10487
	Elbe	10037, 10217, 10218, 10362, 10610
	Elcit	10163
	Electroband	10000
	Electrograph	11755
	Electrohome	10154, 10000, 10463, 10150, 10178, 10030, 10073
	Elekta	10009, 10264
	Elfunk	11037, 11208
	ELG	10037
	Elin	10009, 10037, 10361, 10548
	Elite	10037, 10218
	Elta	10009, 10264
	Emerald	10178
		10047, 10017, 10154, 10451, 10236, 10463, 10180, 10150, 10178, 10171, 11944, 11911, 11909, 10714, 10668, 10623, 10486, 10036, 10371, 10370, 10361, 10037, 10195, 10170, 10070, 10073
	Envision	10030, 10813
	Enzer	10860
	Erae	11371
	Erres	10037
	ESA	10812, 10171, 11944
	ESC	10037, 10217
	Ether	10030, 10009
	Etron	10001, 10009, 10163, 10820
	Eurofeel	10217, 10264
	Euroman	10037, 10217, 10264, 10370
	Europa	10037
	Europhon	10037, 10109, 10217
	Evesham Technology	11248
	Evolution	11756
	Expert	10163
	Exquisit	10037
<b>F</b>	Feilang	10009
	Feilu	10009, 10817
	Feiyan	10264
	Feiyue	10009, 10817
	Fenner	10009, 10374
	Fer0	10335
		10053, 10037, 10073, 10109, 10195, 10287, 10335, 10343, 10443, 10548, 10560, 10625, 11037
	Ferguson	10171, 10037, 10163, 10217, 10264, 10361, 10371, 10512
	Fidelity	10171, 10037, 10163, 10217, 10264, 10361, 10371, 10512
	Filsai	10217
	Finlandia	10163, 10208, 10346, 10361, 10548

	Finlux	10037, 10070, 10163, 10217, 10346, 10480, 10556, 10631, 10714, 10715, 10808, 11556
	Firstar	10236, 10009
	Firstline	10009, 10037, 10208, 10217, 10361, 10374, 10556, 10668, 10714, 10808, 11037, 11191, 11363, 11371
	Fisher	10047, 10054, 10154, 10000, 10036, 10208, 10217, 10361, 10370
	Flint	10037, 10218, 10264, 10455, 10610
	Force	11149
	Formenti	10037, 10163
	Fortress	10093
	Fraba	10037, 10370
	Friac	10009, 10037, 10370, 10499, 10610
	Frontech	10009, 10163, 10217, 10264
	Fujimaro	10865, 11498
	Fujitsu	10009, 10217, 10352, 10683, 10809, 10853
	Fujitsu General	10009, 10217, 10683
	Fujitsu Siemens	10808, 10809, 11163, 11298
	Funai	10000, 10180, 10171, 10264, 10668, 11271, 11904
	Furi	10145, 10264, 10817
	Furichi	10860
	Futronic	10264, 10860
	Futuretech	10180
<b>G</b>	Galaxi	10037
	Galaxis	10037, 10370
	Ganxin	10817
	Gateway	11755, 11756
	GBC	10009, 10163, 10218, 10374
		11447, 10047, 11454, 10000, 10051, 10451, 10093, 10180, 10060, 10178, 10030, 10092, 11922, 11917, 11347, 11147, 10625, 10560, 10335, 10035
	GE	10037, 10163, 10217, 10361
	GEC	10009, 10037, 10217, 10361, 10370, 10394, 10499, 10556, 10634, 10661, 10714, 10808
	Geloso	10009, 10163, 10374
	Gemini	10047
	General	10109, 10287
	General Technic	10009
	Genesis	10009, 10037
	Genexxa	10009, 10037, 10163, 10218
	Gericom	10808, 10865, 10880, 11217, 11298
	Gevalt	11371
	Giant	10009, 10217
	Gibraltar	10017, 10000, 10030
	Go Video	10060, 10886
	Go Vision	11937
	Goldfunk	10668
		10047, 10054, 10154, 10178, 10030, 10715, 10714, 10606, 10455, 10361, 10217, 10163, 10109, 10073, 10037, 10036, 10009, 10061
	GoldStar	10047, 10054, 10154, 10178, 10030, 10715, 10714, 10606, 10455, 10361, 10217, 10163, 10109, 10073, 10037, 10036, 10009, 10061

	Gooding	10487
		10000, 11909, 11900, 11163, 11037, 10880, 10808, 10714, 10668, 10661, 10634, 10625, 10587, 10560, 10556, 10499, 10487, 10480, 10374, 10371, 10343, 10335, 10264, 10218, 10217, 10037, 10036, 10035, 10011, 10009
	Goodmans	10000, 11909, 11900, 11163, 11037, 10880, 10808, 10714, 10668, 10661, 10634, 10625, 10587, 10560, 10556, 10499, 10487, 10480, 10374, 10371, 10343, 10335, 10264, 10218, 10217, 10037, 10036, 10035, 10011, 10009
	Gorenje	10370
	GPM	10218
	Gradiente	10053, 10037, 10170
	Graetz	10163, 10361, 10371, 10487, 10714, 11163
	Gran Prix	10648
	Granada	10036, 10037, 10108, 10163, 10208, 10217, 10226, 10343, 10548, 10560
	Grandin	10009, 10037, 10163, 10218, 10374, 10455, 10610, 10668, 10714, 10715, 10865, 10880, 11037, 11191
	Gronic	10217
		10706, 10009, 10036, 10037, 10070, 10163, 10195, 10443, 10487, 10556, 10587, 10672, 10683, 11371
	Grundig	10706, 10009, 10036, 10037, 10070, 10163, 10195, 10443, 10487, 10556, 10587, 10672, 10683, 11371
	Grundy	10180, 10195
	Grunkel	11163
	Grunpy	10180
<b>H</b>	H & B	10808
	Haaz	10706
	Galaxi	11034, 10037, 10508, 10587, 10698, 11017
	Haihong	10009
	Haiyan	10264, 10817
	Halifax	10217, 10264
	Hallmark	10236, 10180, 10178
	Hampton	10217
	Hanimex	10218
	Hankook	10180, 10178, 10030
	Hanseatic	10009, 10037, 10217, 10361, 10370, 10394, 10499, 10556, 10634, 10661, 10714, 10808
	Hantarex	10009, 10037, 10865
	Hantor	10037
	Harley Davidson	10000, 10180, 10060, 10178, 10030, 11904
	Harman/Kardon	10054
	Harsper	10865
	Harvard	10180
	Harwa	10773, 11196, 11269
	Harwood	10009, 10037, 10487
	Hauppauge	10037
	Havermy	10093
	HCM	10009, 10037, 10217, 10218, 10264, 10418
	Heathkit	10017
	Helios	10865
	Hello Kitty	10451

	Hema	10009, 10217
	Hewlett Packard	11494, 11502
	Hifivox	10109
	Highline	10037, 10264
	Hikona	10218
	Hikone	10218
	Hinari	10009, 10036, 10037, 10163, 10208, 10218, 10264, 10352, 10443
	Hisawa	10218, 10455, 10610, 10714
		10156, 10748, 10145, 10009, 10208, 10508, 10556, 10780, 10821, 10860, 11022, 11156, 11170, 11208, 11363
	Hisense	10047, 10054, 10017, 10000, 11256, 10156, 10051, 10150, 10178, 10030, 11145, 10145, 10092, 10744, 10877, 10634, 11037, 11137, 11149, 11156, 11170, 11225, 11576, 11904, 11960, 10578, 10548, 10508, 10499, 10481, 10480, 10343, 10217, 10163, 10109, 10108, 10037, 10036, 10035, 10009
	Hitachi	10047, 10054, 10017, 10000, 11256, 10156, 10051, 10150, 10178, 10030, 11145, 10145, 10092, 10744, 10877, 10634, 11037, 11137, 11149, 11156, 11170, 11225, 11576, 11904, 11960, 10578, 10548, 10508, 10499, 10481, 10480, 10343, 10217, 10163, 10109, 10108, 10037, 10036, 10035, 10009
	Hitachi Fujian	10150, 10108, 10860
	Hitec	10698
	Hitsu	10009, 10218, 10455, 10610
	Hoehner	10714, 10865, 11163, 11556
	Home Electronics	10606
	Hongmei	10093, 10009, 10264, 10817
	Hongyan	10264, 10817
	Hornophon	10037
	Hoshai	10218, 10455
	HP	11494, 11502
	Hua Tun	10009
	Huafa	10145, 10009
	Huanghaimei	10009
	Huanghe	10009, 10817
	Huanglong	10009
	Huangshan	10009, 10264, 10817
	Huanyu	10217, 10264, 10374, 10817
	Huaqiang	10264
	Huari	10145, 10264
	Hugoson	11217
	Huodateji	10051
	Hygashi	10217
	Hyper	10009, 10217
	Hypersonic	10361
		10037, 10217, 10264, 10455, 10486, 10556, 10668, 10714, 10715, 11037
	Hypson	10037, 10217, 10264, 10455, 10486, 10556, 10668, 10714, 10715, 11037
	Hyundai	10849, 10860, 10865, 10876, 11556
<b>I</b>	Iberia	10037
	ICE	10037, 10217, 10218, 10264, 10371
	ICeS	10218
	Iiyama	10877, 11217

	Ima	10236, 10180, 10178
	Imperial	10037, 10074, 10370, 10418
	Imperial Crown	10001, 10009, 10264, 10374, 10661
	Indiana	10037
	Infinity	10054
	InFocus	11164
	Ingelen	10163, 10487, 10610, 10714
	Ingersol	10009
	Inno Hit	10009, 10217, 10218, 11163
	Innova	10037
	Innowert	10865, 11298
	Inotech	10773, 10820
	Insignia	10171, 11517
	Inteq	10017, 10145
	Interbuy	10009, 10037, 10264
	Interfunk	10037, 10109, 10163, 10200, 10327, 10361, 10512
	Internal	10037, 11909
	Intervision	10009, 10037, 10217, 10218, 10264, 10394, 10455, 10486, 10487
	Irradio	10009, 10037, 10218, 10371
	Isukai	10037, 10218, 10455
	ITC	10217
	ITS	10037, 10218, 10264, 10371
	ITT	10163, 10208, 10346, 10361, 10480, 10548, 10610
		10070, 10163, 10195, 10208, 10346, 10361, 10480, 10548, 10606, 10610
	ITT Nokia	10070, 10163, 10195, 10208, 10346, 10361, 10480, 10548, 10606, 10610
	ITV	10037, 10264, 10374
<b>J</b>	IX	10877
	JBL	10054
	JCB	10000
	JDV	11982
	Jean	10156, 10051, 10236, 10092, 10009, 10036
	JEC	10035
	Jensen	10761, 10815, 10817, 11933
	Jiahua	10051
	JiaLiCai	10009, 10264
	JIL	10030
	Jinfeng	10051, 10208, 10226, 10817
	Jinque	10009, 10264, 10817
	Jinta	10009, 10264
		10054, 10156, 10145, 10009, 10037, 10264, 10556, 10698, 10817, 10821, 11011
	Jinxing	10054, 10156, 10145, 10009, 10037, 10264, 10556, 10698, 10817, 10821, 11011
	JMB	10443, 10499, 10556, 10634
	JNC	10876
	Jocel	10712
	Johnson	10455
	Jubilee	10556
	Juhua	10264, 10817
	Jutan	10030



JVC	10054, 10093, 10463, 10053, 10030, 10070, 10036, 10218, 10371, 10418, 10508, 10606, 10650, 10653, 10683, 10731, 11253, 11923
<b>K</b> Kaige	10009, 10264, 10817
Kaisui	10009, 10037, 10217, 10218, 10455
Kambrook	10217
Kamp	10017, 10180, 10217
Kangli	10001, 10009, 10264, 10374, 10661, 10817
Kangyi	10009, 10264
Kapsch	10163, 10361
Karcher	10264, 10370, 10606, 10610, 10714, 10778, 11556
Kathrein	10556
Kawa	10371
Kawasho	10030
KB Aristocrat	10163
KDS	11498
KEC	10180, 10060
Kendo	10037, 10362, 10370, 10610, 10648, 11037
Kennedy	10163
Kennex	10668, 11037
Kenwood	10180, 10030
Khind	10706
KIC	10217
Kiota	10001, 10371, 10455
Kioto	10706, 10556
Kiton	10037, 10668
KLH	10156, 10180, 10765, 10767, 11962
KLL	10037
Kloss	10030
Kneissel	10037, 10362, 10370, 10374, 10499, 10556, 10610
Kolin	10180, 10150, 10053, 10036, 10108, 11331
Kolster	10037, 10218
Kongque	10009, 10264, 10817
Konichi	10009
Konig	10037
Konka	10180, 10037, 10218, 10371, 10418, 10587, 10641, 10714, 10817, 11084
Kontakt	10487
Korpel	10037
Korting	10370
Kosmos	10037
Koyoda	10009
Kreisen	10876
KTV	10463, 10180, 10030, 10217
Kuaile	10009, 10264
Kulun	10009
Kunlun	10051, 10208, 10226, 10264, 10374, 10661, 10817

**L**

Kyoshu	10418
Kyoto	10163, 10217
L&S Electronic	10714, 10808, 10865
Lark	10154
LaSAT	10486
Lavis	11037
Leader	10009
Lecson	10037
Legend	10009
Lenco	10037, 10374, 10587
Lenoir	10009
Lexsor	11196
Leyco	10037, 10264
LG	10054, 11265, 10060, 10178, 10030, 11758, 11637, 11191, 11178, 10856, 10715, 10714, 10700, 10698, 10556, 10370, 10361, 10217, 10163, 10109, 10108, 10037, 10009, 10001
Liesenk & Tter	10037
Liesenkotter	10037, 10327
Lifetec	10009, 10037, 10218, 10374, 10668, 10683, 10714, 11037, 11137
Lihua	10817
Lloyd's	10236, 10180, 10030, 10001, 10009, 11904
Local India TV	10009, 10208, 10602
Local Malaysia TV	10698
Lodos	11037
Loewe	10037, 10370, 10512, 10633, 10790
Logik	10236, 10180, 10060, 10001, 10009, 10011, 10371, 10698, 10773, 10880, 11037, 11217
Logix	10668
Longjiang	10264, 10817
Luker	11982
Luma	10009, 10163, 10362, 10374, 11037
Lumatron	10037, 10073, 10163, 10217, 10264, 10361, 10556
Lux May	10009, 10037
Luxor	10163, 10208, 10217, 10346, 10361, 10480, 10548, 10631, 11037, 11163
LXI	10047, 10054, 10017, 10154, 10000, 10156, 10051, 10093, 10060, 10053, 10178, 10030, 10171, 10166, 10037, 10036, 10035, 10001, 10208
<b>M</b> M Electronic	10009, 10037, 10109, 10163, 10195, 10217, 10287, 10343, 10346, 10374, 10480, 10512, 10634, 10661, 10714
Madison	10037
MAG	11498
Magnadyne	10054, 10163
Magnafon	10073
Magnasonic	10054, 10000, 10156, 10093, 10030, 10092, 10109

Magnavox	10047, 11454, 10054, 10154, 10000, 10250, 10051, 10180, 10060, 10030, 10171, 10092, 10706, 11944, 11904, 11755, 11254, 10802, 10780, 10011, 10035, 10037, 10036
Magnum	10037, 10648, 10714, 10715
Majestic	10017
Mandor	10264
Manesth	10035, 10037, 10217, 10264
Manhattan	10037, 10668, 10778, 10876, 11037, 11267
Marantz	11454, 10054, 10030, 10037, 10556, 10704, 10855
Mark	10009, 10037, 10217, 10374, 10714, 10715
Master's	10499
Mastro	10053, 10706, 10698, 10780
Masuda	10009, 10037, 10217, 10218, 10264, 10371
Matsui	11037, 10744, 10714, 10556, 10487, 10455, 10443, 10433, 10371, 10352, 10335, 10217, 10208, 10195, 10163, 10037, 10036, 10035, 10011, 10009
Matsushita	10250, 10051, 10650
Maxdorf	10773
Maxent	11755, 11756
Maxim	11556, 11982
MCE	10009
Meck	10698
Mediator	10037, 10556
Medion	10037, 10512, 10556, 10668, 10698, 10714, 10808, 10880, 11037, 11137, 11248, 11900
Megapower	10700
Megas	10610
Megatron	10047, 10178, 10145, 10009
MEI	11037
Meile	10264, 10817
Memorex	10154, 10250, 10463, 10180, 10150, 10060, 10178, 10030, 10009, 10035, 10037, 10195, 10877, 11037, 11911
Memphis	10009
Mercury	10060, 10001, 10009, 10037
Mermaid	10037
Metronic	10625
Metz	10037, 10195, 10367, 10388, 10447, 10587, 10668, 10746, 11163
MGA	10150, 10178, 10030, 10218, 10374
MGN Technology	10178
Micro Genius	10150
Micromaxx	10037, 10668, 10714, 10808, 11037
Microstar	10808
MicroTEK	10820, 10860
Midland	10047, 10017, 10051
Mikomi	11037, 11149

**N**

Minato	10037, 10556
Minerva	10070, 10108, 10195, 10487
Minoka	10037
Mirror	11900
Mitsubishi	10154, 10250, 10093, 10236, 10180, 11250, 10150, 10178, 10030, 11917, 11037, 10836, 10817, 10556, 10512, 10195, 10108, 10037, 10036, 10011
Mivar	10217
Monaco	10009
Monivision	10700, 10843
Morgan's	10037
Motorola	10054, 10051, 10093, 10150
MTC	10180, 10060, 10030, 10092, 10011, 10370, 10512
MTlogic	10714
Mudan	10051, 10009, 10208, 10226, 10264, 10817
Multitec	10037, 10486, 10668, 11037, 11556
Multitech	10180, 10009, 10037, 10217, 10264, 10370, 10486
Murphy	10163
Musikland	10218
Mx Onda	11498
Myryad	10556
NAD	10156, 10178, 10166, 10037, 10361, 10866, 11156
Naiko	10037, 10606, 11982
Nakimura	10037, 10374
Nanbao	10009, 10264
Nansheng	10264, 10817
Narita	11982
NAT	10226
National	10051, 10208, 10226, 10508
NEC	10047, 10154, 10156, 10051, 10053, 10178, 10030, 11704, 11270, 11170, 10817, 10704, 10661, 10653, 10508, 10499, 10455, 10374, 10264, 10217, 10170, 10036, 10011, 10009
Neckermann	10037, 10200, 10327, 10370, 10418, 10556
NEI	10037, 10163, 10371
Neovia	10865, 10876, 11371
Netsat	10037
NetTV	11755
Neufunk	10009, 10037, 10218, 10556, 10610, 10714
New Tech	10009, 10037, 10217, 10343, 10556
New World	10218
Newwave	10093, 10178, 10092, 10009
Nikkai	10009, 10035, 10036, 10037, 10163, 10217, 10218, 10264
Nikkei	10714
Nikko	10178, 10030, 10092
Nikkodo	10178, 10030, 10092

**O**

Nishi	10030
Noblisko	10070
Nogamatic	10109
Nokia	10163, 10208, 10346, 10361, 10374, 10480, 10548, 10606, 10610, 10631
Norcent	10748, 10824
Nordic	10217
Nordmende	10037, 10109, 10195, 10287, 10343, 10560, 10714
Normerel	10037
Novatronic	10037, 10374
NTC	10092
Nu-Tec	10455, 10698, 10820
Nyon	10000
Oceanic	10163, 10208, 10361, 10548
Odeon	10264
Okano	10009, 10037, 10264, 10370
Olevia	11144, 11240, 11331, 11610
Omega	10264
Omni	10748, 10698, 10780, 10872
Onida	10053, 11253
Onimax	10714
Onwa	10180, 10218, 10371, 10433, 10602
Opera	10037
Optimus	10154, 10250, 10093, 10180, 10150, 10178, 10030, 10166, 10650
Optoma	10887
Optonica	10093
Orbit	10037
Orcom	11504
Orion	10017, 10236, 10463, 10180, 10178, 11463, 10011, 10037, 10264, 10443, 10556, 10714, 10880, 11196, 11911
Orline	10037, 10218
Ormond	10668, 11037
Osaki	10037, 10217, 10218, 10264, 10374, 10556
Osio	10037
Oso	10218
Osume	10036, 10037, 10218
Otic	11498
Otto Versand	10093, 10036, 10037, 10109, 10195, 10217, 10226, 10343, 10361, 10512, 10556
<b>P</b> Pace	10092
Pacific	10037, 10443, 10556, 10714, 11037, 11137
Palladium	10037, 10163, 10200, 10217, 10327, 10370, 10418, 10556, 10714, 11137
Palsonic	10001, 10037, 10217, 10218, 10264, 10418, 10698, 10773, 10778, 11196, 11269, 11904
Panama	10009, 10037, 10217, 10264
Panashiba	10001

Panasonic	10054, 10000, 10156, 10250, 10051, 10236, 10030, 11947, 11946, 11941, 11480, 11310, 11291, 11271, 10853, 10650, 10548, 10508, 10367, 10361, 10226, 10208, 10163, 10108, 10037, 10035
Panavision	10037
Panda	10051, 10706, 10009, 10208, 10226, 10264, 10508, 10698, 10780, 10817, 10821
Pathe Cinema	10163
Pathe Marconi	10109
Pausa	10009
Paxonic	10060, 10030
PCE	10156, 10060
Penney	10047, 10000, 10156, 10250, 10051, 10060, 10178, 10030, 10035, 10036, 10037, 10070, 10108, 11347
Perdio	10037, 10163
Perfekt	10037
Petters	11523
Philco	10054, 10451, 10463, 10180, 10178, 10030, 10145, 11661, 10037, 10074, 10163, 10370, 10418
Philharmonic	10217
Philips	11454, 10054, 10017, 10000, 10051, 10178, 10030, 10171, 10092, 11961, 11756, 11254, 10690, 10556, 10512, 10374, 10361, 10343, 10200, 10108, 10037, 10009
Phocus	10714
Phoenix	10037, 10163, 10370, 10486
Phonola	10037, 10556
Pilot	10051, 10060, 10178, 10030, 10706, 10011
Pioneer	10166, 10011, 10037, 10109, 10163, 10170, 10287, 10361, 10370, 10486, 10512, 10679, 10760, 10866, 11260
Pionier	10370, 10486, 11556
Plantron	10009, 10037, 10264
Playsonic	10037, 10217, 10714, 10715
Polaroid	10765, 10865, 11276, 11316, 11341, 11498, 11523
Poppy	10009
Portland	10451, 10092, 10374
Powerpoint	10037, 10487, 10698
Prandoni-Prince	10361
Precision	10236, 10180, 10217
Premier	10009, 10264
President	10860
Prima	10761, 10009, 10264, 10783, 10815, 10817, 11269, 11933
Princeton	10700
Prinston	11037
Prinz	10361
Prism	10250, 10051

Profex	10009, 10163, 10361
Profi	10009
Profilo	11556
Profitronic	10037
Proline	10037, 10073, 10625, 10634, 11037
Proscan	11447, 10047, 11347, 11922
Proscoc	10156
Prosonic	10037, 10217, 10370, 10371, 10374, 10668, 10714
Protec	10009, 10037, 10217, 10264
Protech	10009, 10037, 10217, 10264, 10418, 10486, 10668, 11037
Proton	10178, 10030, 10001, 10009
Proview	11498
ProVision	10037, 10556, 10714, 11037
Pulsar	10017, 10092
Pulser	10178, 10092
Pvision	10876, 11191
Pye	10037, 10374, 10556
Pymi	10009
Qingdao	10051, 10208, 10226, 10264, 10817
Quadral	10051, 10218
Quartz	10150, 10178
Quasar	10250, 10051, 10009, 10035, 10650, 10865
Quelle	10011, 10037, 10070, 10074, 10109, 10195, 10200, 10327, 10361, 10512, 10668, 11037
Questa	10036
Questar	10036
R-Line	10037
Rabbit	10047
Radialva	10163, 10218
Radiola	10037, 10217, 10556
Radiomarelli	10037
RadioShack	10047, 10154, 10180, 10150, 10178, 10030, 10037, 11904
Radiotone	10009, 10037, 10264, 10370, 10418, 10648, 10668, 11037
Rank	10070
Rank Arena	10036, 10602
RBM	10070
RCA	11447, 10047, 11454, 10054, 10000, 10051, 10093, 10178, 10030, 10092, 11958, 11953, 11948, 11922, 11917, 11547, 11347, 11247, 11147, 11047, 10679, 10625, 10560, 10090
Realistic	10047, 10154, 10180, 10150, 10178, 10030
Recor	10037, 10418
Rectiligne	10037
Reddiffusion	10036, 10163, 10346, 10361, 10548
Redstar	10037
Reflex	10037, 10668, 11037
Relisys	10865, 10876, 10877, 11207, 11298

**S**

Remotec	10250, 10093, 10145, 10171, 10037
Reoc	10714
Revov	10037
Rex	10163, 10264
RFT	10037, 10264
Rinex	10773
Roadstar	10009, 10037, 10218, 10264, 10418, 10668, 10714, 11037, 11900
Rolson	11371
Rover	10036, 10877
Rowa	10748, 10009, 10037, 10264, 10587, 10698, 10712, 10817
Royal Lux	10335, 10370
Runco	10017, 10060, 10030
Ruyi	10817
Saba	10250, 10109, 10163, 10287, 10335, 10343, 10361, 10498, 10548, 10560, 10625, 10714
Sagem	10455, 10610, 10618
Saige	10009, 10817
Saisho	10009, 10011, 10163, 10217, 10264
Saivod	10037, 10668, 10712, 11037, 11163, 11556, 11982
Sakai	10163
Sakyno	10455
Salora	10163, 10208, 10361, 10480, 10548, 10631
Salsa	10335
Sampo	10047, 10154, 10093, 10178, 10030, 10171, 10092, 10009, 10036, 10650, 10700, 11755, 11756
Samsung	10047, 10054, 10017, 10154, 10156, 10093, 10060, 10812, 10702, 10178, 10030, 10092, 10814, 10766, 10718, 10618, 10587, 10817, 10821, 11060, 11249, 11312, 11903, 11959, 10556, 10371, 10370, 10362, 10264, 10226, 10217, 10208, 10163, 10090, 10037, 10036, 10035, 10009
Sandra	10217
Sanjian	10264
Sanky	10060, 10030
Sansui	10463, 10060, 10030, 10706, 10037, 10371, 10455, 10602, 10714, 10861, 11371, 11537, 11904, 11911
Santon	10009
Sanyo	10047, 10054, 10154, 10000, 10156, 10463, 10180, 10145, 10171, 11755, 11208, 10704, 10508, 10370, 10264, 10217, 10208, 10170, 10163, 10108, 10088, 10037, 10036, 10011, 10009
Sanyong	10037
Sanyuan	10093, 10009, 10817
Saville	10060

SBR	10037, 10556
Sceptre	11217
Schaub Lorenz	10361, 10374, 10486, 10548, 10606, 10714, 11191
Schneider	11982, 11904, 11137, 11037, 10714, 10668, 10648, 10556, 10394, 10371, 10361, 10352, 10343, 10218, 10217, 10163, 10070, 10037
Scotch	10178
Scotland	10163
Scott	10236, 10180, 10178, 10030
Sears	10047, 10054, 10017, 10154, 10000, 10156, 10051, 10093, 10060, 10053, 10178, 10030, 10171, 10166, 10035, 10036, 10037, 10001, 10208, 11904
Seaway	10634
Seelver	11037
SEG	10009, 10036, 10037, 10217, 10218, 10264, 10362, 10487, 10668, 11037, 11163
SEI	10037, 10163
Sei-Sinudyne	10037
Seleco	10163, 10264, 10346, 10362, 10371
Semivox	10180
Semp	10156
Sencora	10009
Sentra	10035
Serino	10093, 10455, 10610
Shancha	10264, 10817
Shanghai	10009, 10208, 10226, 10264, 10817
Shaofeng	10145, 10817
Sharp	10054, 10093, 10180, 10053, 10030, 10009, 10036, 10200, 10650, 10653, 10668, 11193, 11393, 11917
Shen Ying	10092, 10009
Shencai	10145, 10009, 10264
Sheng Chia	10093, 10236, 10009
Shenyang	10009, 10264, 10817
Sherwood	10009
Shintoshii	10037
Shivaki	10178, 10037, 10374, 10443, 10556
Show	10009, 10418
Siarem	10163
Siemens	10145, 10037, 10195, 10200, 10327
Siera	10037, 10556
Siesta	10370
Signature	10047, 10093, 10030
Silva	10037, 10361, 10648
Silva Schneider	10037, 11556
Silvano	10587
Silver	10036, 10361, 10455, 10715
SilverCrest	11037

Simpson	10178, 10030, 10011
Singer	10060, 10092, 10009, 10037, 10335, 10371, 10433, 11537
Sinotec	10773
Sinudyne	10037, 10163, 10361
Skantic	10163
SKY	10037, 10880, 11504
Sky Brazil	10880
Sky-North	10037
Skygiant	10180
Skyworth	10748, 10009, 10037, 10264, 10698, 10805, 10817, 11115
Sliding	10865, 10880
SLX	10668
Smaragd	10487
Soemtron	10865, 11298
Solar Drape	10000
Solavox	10037, 10163, 10361, 10548
Sole	10813
Sonawa	10218
Songba	10009
Soniko	10037
Sonitron	10208, 10217, 10370
Sonneclair	10037
Sonoko	10009, 10037, 10217, 10264
Sonolor	10163, 10208, 10361, 10548
Sontec	10009, 10037, 10370
Sony	10017, 10154, 11100, 10000, 10150, 10053, 10011, 10036, 10037, 10074, 10353, 10650, 11505, 11651, 11751, 11904
Sound & Vision	10218, 10374
Soundesign	10180, 10178
Soundwave	10037, 10418, 10715
Sova	11952
Sowa	10156, 10051, 10060, 10178, 10092, 10036, 10226
Soyea	10773
Spectra	10009
Spectravision	10156, 10178
Spectroniq	11498
Squareview	10171
SR2000	10154, 10171
SSangyong	10009
SSS	10180
Staksonic	10009
Standard	10009, 10037, 10217, 10218, 10374, 11037
Standard Components	10009, 10218
Starlite	10236, 10180, 10009, 10037, 10163, 10264
Stenway	10218
Stern	10163, 10264
Stevison	11982
Strato	10009, 10037, 10264

Strong	11149, 11163
Studio Experience	10843
Stylandia	10217
Sunkai	10218, 10455, 10487, 10610, 10865
Sunstar	10009, 10037, 10264, 10371
Sunwatt	10455
Sunwood	10037
Superla	10217
Superscan	10093, 10864, 11944
Supersonic	10009, 10208, 10455, 10805
SuperTech	10009, 10037, 10218, 10556
Supra	10178, 10009, 10374
Supreme	10000
Susumu	10218, 10287, 10335
Sutron	10009
SV2000	10054
SVA	10748, 10587, 10865, 10870, 10871, 10872
Svasa	10455
Swisstec	10880, 11504
Sydney	10217
Sylvania	10047, 10054, 10154, 10000, 10051, 10178, 10030, 10171, 10092, 10036, 10037, 10876, 11271, 11904, 11944
Symphonic	10000, 10180, 10178, 10171, 11904, 11944
Synco	10000, 10451, 10093, 10060, 10178, 10092, 10036
Syntax	11144, 11240, 11331
Sysline	10037
T+A	10447
Tacico	10178, 10092, 10009
Tai Yi	10009
Taishan	10009, 10374, 10817
Tandberg	10109, 10361, 10367
Tandy	10093, 10163, 10217, 10218
Targa	11371
Tashiko	10092, 10036, 10163, 10170, 10217, 10650
Tatung	10054, 10154, 10000, 10156, 10051, 10060, 10037, 10036, 10011, 10009, 10217, 11156, 11191, 11248, 11254, 11371, 11556, 11756
TCL	10706, 10698, 11027, 11537
TCM	10714, 10808
Teac	10154, 10178, 10171, 10706, 11755, 11149, 11037, 10714, 10712, 10698, 10668, 10512, 10455, 10418, 10264, 10217, 10170, 10037, 10009
Tec	10009, 10037, 10163, 10217, 10335
Tech Line	10037, 10668, 11163
Techica	10218
Technica	11982

Technics	10054, 10250, 10051, 10226, 10556, 10650
TechniSat	10556, 11267
Technisson	10714
Technosonic	10499, 10556
Technovox	10030, 10217
Techview	10847
Techwood	10250, 10051, 10060, 11163
Tecnimagen	10556
Teco	10051, 10093, 10178, 10092, 10009, 10036, 10218, 10264, 10653, 11040
Tedelex	10009, 10208, 10217, 10418, 10606, 10698, 11537
Teiron	10009
Tek	10820
Teknika	10054, 10463, 10180, 10150, 10060, 10178, 10092
Tele System Electronic	10876
Teleavia	10287, 10343
Telecolor	10017
Telecor	10037, 10163, 10217, 10218, 10394
Telefunken	10702, 11504, 10821, 10820, 10819, 10714, 10712, 10698, 10625, 10587, 10560, 10498, 10486, 10346, 10343, 10335, 10287, 10109, 10074, 10073, 10037
Tелефusion	10037
Telegazi	10037, 10163, 10218, 10264
Telemeister	10037
Telesonic	10037
Telestar	10009, 10037, 10556
Teletech	10009, 10037, 10668, 11037
Teleton	10036, 10217
Televideon	10163
Televiev	10037
Tempest	10009, 10264, 10455
Tennessee	10037
Tensai	10009, 10037, 10217, 10218, 10371, 10374, 10715, 11037
Tenson	10009
Tera	10030, 10092
Tevion	10037, 10556, 10648, 10668, 10714, 10808, 11037, 11137, 11248, 11298, 11498, 11556
Textet	10009, 10217, 10218, 10374
Texla	10780
ThemeScene	10887
Thomas	10047, 10178, 10001, 11904
Thomson	11447, 10047, 10037, 10109, 10287, 10335, 10343, 10560, 10625
Thorn	10035, 10036, 10037, 10073, 10074, 10109, 10163, 10264, 10335, 10343, 10361, 10499, 10512
Thorn-Ferguson	10073, 10335, 10343, 10499

Tiane	10093, 10817
Tiny	11269
TMK	10236, 10180, 10178
TML	11756
TNCi	10017
Tobishi	10218
Tobo	10748, 10009, 10264
Tocom	10156
Tokai	10009, 10037, 10163, 10217, 10374, 10668, 11037
Tokaido	11037
Tokyo	10035
Tomashi	10218
Tongguang	10264
Tongtel	10587, 10780
Topline	10668, 11037
Toshiba	10154, 11256, 10156, 10150, 11265, 10060, 11145, 10145, 10166, 11037, 11156, 11163, 11164, 11356, 11508, 11556, 11656, 11704, 11945, 11971, 10845, 10821, 10718, 10650, 10618, 10508, 10264, 10217, 10195, 10109, 10070, 10036, 10035, 10011, 10009
Totevision	10051
Towada	10217
Toyoda	10009, 10264, 10371
Toyomenka	10178
Trakton	10217, 10264
Trans Continens	10037, 10217, 10668, 11037
TRANS-continents	10556, 10865
Transonic	10009, 10037, 10264, 10418, 10455, 10512, 10587, 10698, 10712, 10780
Triad	10218, 10556
Trident	10217
Trio	11498
Tristar	10218, 10264
Triumph	10037, 10346, 10556
Truetone	10250, 10051
Tuntex	10030, 10092, 10009
TVS	10463
TVTEXT 95	10556
Uher	10037, 10370, 10374, 10418, 10480, 10486
Ultra	10092
Ultravox	10037, 10163, 10374
Unic Line	10037, 10455
United	10037, 10587, 10714, 10715, 11037, 11982
Universal	10047, 10037
Universum	11163, 11037, 10668, 10631, 10618, 10512, 10480, 10418, 10370, 10362, 10361, 10346, 10327, 10264, 10217, 10200, 10195, 10170, 10109, 10074, 10070, 10037, 10036, 10011, 10009

Univox	10037, 10163
V	10864, 10885, 11755, 11756
V2max	10865
V7 Videoseven	10880, 11217, 11755
Vector Research	10030
Vestel	10037, 10217, 10668, 11037, 11163
Vexa	10009, 10037
Victor	10250, 10053, 10036, 10650, 10653
Videocon	10508
Videologic	10218
Videologique	10217, 10218
Videomac	10009
VideoSystem	10037
Videotechnic	10217, 10374
Videoton	10163
Vidikron	10054
Vidtech	10178, 10036
Viewpia	10876
Viewsonic	10857, 10864, 10885, 11330, 11578, 11627, 11755
Viking	10060
Viore	11207
Vision	10037, 10217, 10264
Vizio	10864, 10885, 11755, 11756, 11758
Vortec	10037
Voxson	10178, 10037, 10163, 10418
Waltham	10037, 10109, 10217, 10418, 10443, 10668, 11037
Wards	10047, 10054, 10017, 10154, 10000, 10156, 10051, 10093, 10236, 10180, 10060, 10178, 10030, 10166, 11347, 11156, 11147, 10866, 10195, 10001, 10037, 10035
Warumaia	10374, 10661
Watson	10009, 10037, 10163, 10218, 10394, 10668, 10714, 11037
Watt Radio	10163
Waycon	10156
Wega	10036, 10037
Wegavox	10009
Weipai	10009
Welltech	10714
Weltblick	10217
Welton	10178
Weltstar	11037
Westinghouse	10000, 10451, 10885, 10889, 11282, 11577
Wharfedale	10037, 10556, 10860, 11556
White	10451, 10236, 10463, 10037, 10623, 10889, 11909
Windsor	10668, 11037
Windy Sam	10556
Wintel	10714
World	10451, 10236, 10463, 10180

World-of-Vision	10865, 10877, 10880, 11217, 11298
Worldview	10455
X-View	11191
Xenius	10634, 10661
Xiahua	10009, 10264, 10698, 10773, 10817
Xianghai	10009
Xiangyang	10264
Xiangyu	10009
Xihu	10264, 10817
Xingfu	10009
Xinghai	10264
XLogic	10698, 10860
Xoceco	11064
Xoro	11196, 11217
XR-1000	10154, 10180, 10171
Xrypton	10037
Yamaha	10030, 10650, 11576
Yamishi	10037, 10217, 10218, 10455
Yapshie	10250
Yingge	10009
Yokan	10037
Yoko	10009, 10037, 10217, 10218, 10264, 10370
Yonggu	10009
Yorx	10030, 10218
Youlanasi	10817
Yousida	10009
Yuhang	10009
Zanussi	10163, 10217, 10264
Zenith	10047, 10017, 10000, 10093, 10463, 11265, 10812, 10178, 10030, 11145, 10145, 10171, 10092, 10037, 11904, 11909, 11911
ZhuHai	10009, 10374

## TV/DVD Combination ※2, ※4

※2

<b>A</b> Advent	11933
Akai	11675
Akura	11982
Alba	11037
Amstrad	11982
Apex Digital	11943
Audiovox	11937, 11951, 11952
Axion	11937, 11958
<b>B</b> Black Diamond	11037
Bush	10698, 11037, 11900
<b>C</b> Centrum	11037
Crown	11037
<b>D</b> D-Vision	11982
Denver	10587



<b>S</b>	Sharp	11917
	Sylvania	11944
	Symphonic	11944
<b>T</b>	Toshiba	11945

※3

<b>S</b>	Sharp	20807
----------	-------	-------

※4

<b>A</b>	Akai	30899
<b>E</b>	Emerson	30821
	ESA	30821
<b>M</b>	Magnavox	30821
<b>P</b>	Panasonic	31362, 31462
<b>R</b>	RCA	31132
<b>S</b>	Sharp	30630
	Superscan	30821
	Sylvania	30821
	Symphonic	30821
<b>T</b>	Toshiba	31045

## VCR

<b>A</b>	A-Mark	20037, 20240, 20000, 20278, 20046
	ABS	21972
	Admiral	20060, 20048, 20039, 20047, 20104, 20121, 20209, 20479
	Adventura	20037, 20240, 20000
	Aiko	20278
	Aim	20278, 20348, 20642
	Aiwa	20037, 20032, 20000, 20209, 20041, 20348, 20352, 20479, 20742, 21137
	Akai	20037, 20240, 20041, 20106, 20315, 20348, 20352, 20642
	Akura	20041
	Alba	20081, 20000, 20209, 20278, 20315, 20348, 20352
	Alienware	21972
	Allegro	20039, 21137
	Allorgan	20240
	Allstar	20081
	America Action	20278
	American High	20035, 20081
	Amoisonic	20479
	Amstrad	20000, 20278
	Anam	20162, 20037, 20240, 20278, 20226, 20480
	Anam National	20162, 20226, 21162, 21562
	Ansonic	20000
	Aristona	20081
	ASA	20037, 20081
	Asha	20240
	Astra	20035, 20240
	Asuka	20037, 20081, 20000, 20038

	Audiolab	20081
	Audiosonic	20278
	Audiovox	20037, 20278, 20038
	Avis	20000
	AVP	20000, 20352
	Awa	20037, 20043, 20278, 20642

**B**

	Baird	20000, 20104, 20041, 20278, 20046, 20106
	Basic Line	20104, 20278, 20046
	Beaumont	20240
	Beko	20104
	Bell & Howell	20035, 20048, 20039, 20000, 20104, 20046, 20479
	Bestar	20278
	Black Diamond	20642
	Black Panther	20278
	Blaupunkt	20162, 20081, 20226
	Blue Sky	20037, 20209, 20278, 20348, 20352, 20480, 20642, 20742, 21137
	BPL	20046
	Brandt	20041, 20320
	Brandt Electronique	20041
	Brinkmann	20209, 20348
	Broksonic	20184, 20121, 20209, 20002, 20348, 20479, 21479
	Bush	20081, 20000, 20209, 20278, 20315, 20348, 20352, 20642, 20742

**C**

	Calix	20037
	Candle	20037, 20038
	Canon	20035
	Capehart	20002
	Carena	20081, 20209
	Carrefour	20045
	Carrera	20240
	Carver	20035, 20081
	Casio	20000
	Cathay	20278
	CCE	20278
	CGE	20000, 20041
	Changhong	20048, 20081
	Cimline	20209
	Cineral	20278
	CineVision	21137
	Citizen	20035, 20037, 20240, 20000, 20209, 20278, 20479, 21278
	Classic	20037
	Clatronic	20000, 21593
	Colorlyme	20060, 20035, 20045, 20278
	Colt	20000
	Combitech	20352
	Condor	20278
	Craig	20037, 20047, 20240
	Criterion	20000

**D**

	Crosley	20035, 20081, 20000
	Crown	20037, 20278, 20480
	Curtis Mathes	20060, 20035, 20162, 20240, 20000, 20041, 20278, 20432, 21035
	Cybernex	20240
	CyberPower	21972
	Cyrus	20081
	Daewoo	20037, 20045, 20104, 20209, 20278, 20046, 20352, 20637, 20642, 21137, 21278
	Dansai	20278
	Dantax	20352
	Daytron	20037, 20278
	De Graaf	20048, 20081, 20042, 20104, 20046
	Decca	20081, 20000, 20067, 20209, 20041, 20352
	Degraff	20048, 20081, 20042, 20104
	Deitron	20278
	Dell	21972
	Denon	20081, 20042
	Derwent	20041
	Diamant	20037
	Diamond	20348
	Digitor	20642
	DirecTV	20739
	Domland	20209
	DSE	20642
	Dual	20081, 20000, 20041, 20278, 20348
	Dumont	20081, 20000, 20104
	Durabrand	20039, 20038, 20642
	Dynatech	20240, 20000
<b>E</b>	Elbe	20278, 20038
	Electrohome	20060, 20037, 20240, 20000, 20043, 20209
	Electroponic	20037
	Elin	20240
	Elta	20278
	Emerald	20184, 20121
	Emerex	20032
	Emerson	20035, 20037, 20184, 20039, 20240, 20045, 20000, 20121, 20043, 20209, 20002, 20278, 20348, 20479, 20637, 21278, 21479, 21593
	ESA	21137
	ESC	20240, 20278
	EuroLine	21593
<b>F</b>	Ferguson	20000, 20041, 20278, 20320, 20348
	Fidelity	20240, 20000, 20352, 20432
	Finlandia	20037, 20048, 20081, 20000, 20042, 20104, 20043, 20046, 20106, 20226
	Finlux	20081, 20000, 20042, 20104

**G**

	Firstline	20037, 20045, 20042, 20043, 20209, 20278, 20348, 20480, 21137
	Fisher	20039, 20047, 20000, 20104, 20046
	Flint	20209, 20348
	Fuji	20035, 20033
	Fujitsu	20037, 20045, 20000
	Fujitsu General	20037
	Funai	20037, 20000, 20278, 21593
	Galaxi	20000
	Galaxis	20278
	Garrard	20000
	Gateway	21972
	GE	20060, 20035, 20048, 20240, 20000, 20226, 20320, 20807, 21035, 21060
	GEC	20081
	Gemini	20060
	General	20045
	General Technic	20348
	Genexxa	20037, 20000, 20104, 20278
	Go Video	20240, 20432, 20614, 21137
	GoldStar	20035, 20037, 20039, 20000, 20209, 20278, 20038, 20225, 20226, 20480, 21137, 21237
	Goodmans	20037, 20081, 20240, 20000, 20209, 20278, 20348, 20352, 20637, 20642, 20742
	GPX	20037
	Gradiente	20000
	Graetz	20240, 20104, 20041
	Granada	20035, 20037, 20048, 20081, 20240, 20000, 20042, 20104, 20046, 20226
	Grandin	20037, 20000, 20209, 20278, 20742
	Grundig	20081, 20226, 20320, 20347, 20348, 20352, 20742
<b>H</b>	Haaz	20348
	Hanimex	20352
	Hanseatic	20037, 20081, 20209, 20038
	Haojie	20240
	Harley Davidson	20000
	Harman/Kardon	20081, 20038
	Headquarter	20046
	Hewlett Packard	21972
	Hi-Q	20035, 20047, 20000
	Hinari	20240, 20209, 20041, 20278, 20352
	Hisawa	20209, 2035
	Hischito	20045
	Hitachi	20035, 20037, 20081, 20240, 20045, 20000, 20042, 20041, 20046, 20089
	Hoehner	20278, 20642
	Hornophon	20081
	Howard Computers	21972
	HP	21972

	Hughes Network Systems	20042, 20739
	Humax	20739
	Hush	21972
	Hypson	20037, 20000, 20209, 20278, 20352, 20480
	Hytek	20047, 20000
<b>I</b>	iBUYPOWER	21972
	Imperial	20000
	Ingersol	20240, 20209
	Interbuy	20037
	Interfunk	20081, 20104
	Internal	20278, 20637
	International	20037, 20278, 20642
	Intervision	20037, 20000, 20209, 20278, 20348
	Irradio	20037, 20081, 21137
	ITT	20240, 20104, 20041, 20046, 20106
	ITT Nokia	20240, 20104, 20041, 20106
	ITV	20037, 20278
<b>J</b>	Janeil	20240
	JBL	20278
	Jensen	20067, 20041
	JMB	20209, 20348, 20352, 20742
	Joyce	20000
	JVC	20184, 20081, 20045, 20067, 20041, 21162
<b>K</b>	Kambrook	20037
	Karcher	20081, 20278, 20642
	KEC	20037, 20278
	Kendo	20037, 20209, 20278, 20106, 20315, 20348, 20642
	Kenwood	20067, 20041, 20038, 20046
	KIC	20000
	Kimari	20047
	Kneissel	20037, 20209, 20278, 20348, 20352
	Kodak	20035, 20037
	Kolin	20043, 20041
	Kolster	20209
	KTV	20000
	Kuba	20047
	Kuba Electronic	20047
<b>L</b>	Lenco	20278
	LG	20037, 20240, 20045, 20000, 20042, 20209, 20278, 20038, 20225, 20480, 21137, 21237
	Lifetec	20209, 20348
	Linksys	21972
	Lloyd's	20240, 20000, 20038
	Loewe	21062, 20162, 20037, 20081, 21262, 21562
	Logik	20240, 20000, 20209, 20106
	Lumatron	20278, 21137
	Lunatron	21137

Luxor	20048, 20047, 20104, 20043, 20046, 20106, 20315
LXI	20037, 20000, 20042, 20067
M Electronic	20037, 20240, 20000, 20038
Magnadyne	20081
Magnasonic	20037, 20240, 20000, 20278, 21278
Magnavox	20035, 20037, 20048, 20039, 20081, 20240, 20000, 20226, 20618, 20642, 21593, 21781
Magnin	20240
Magnum	20642
Manesth	20081, 20045, 20209
Marantz	20035, 20081, 20209, 20038
Mark	20000, 20278
Marta	20037
Mastec	20642
Master's	20278
Matsui	20037, 20240, 20209, 20278, 20348, 20352, 20742
Matsushita	20035, 20162, 20081, 20226, 21162
Media Center PC	21972
Mediator	20081
Medion	20209, 20348, 20352, 20642
MEI	20035
Memorex	20035, 20162, 20037, 20048, 20039, 20047, 20240, 20000, 20104, 20209, 20278, 20046, 20348, 20479, 21162, 21237, 21262
Metronic	20081
Metz	21062, 20162, 20037, 20081, 20226, 20347, 20836, 21162, 21262, 21562
MGA	20060, 20240, 20043
MGN Technology	20240
Micormay	20348
Micromaxx	20209
Microsoft	21972
Midland	20240
Migros	20000
Mind	21972
Minolta	20042
Mitsubishi	20060, 20048, 20047, 20081, 20000, 20042, 20067, 20043, 20041, 20480, 20642, 20807
Motorola	20035, 20048
MTC	20240, 20000
MTX	20000
Multitec	20037
Multitech	20039, 20000
Murphy	20000
Myryad	20081
NAD	20240, 20104
Naiko	20348, 20642
NAP	20039
National	20226

Nebula Electronics	20033
NEC	20035, 20037, 20048, 20104, 20067, 20041, 20278, 20038, 21137
Neckermann	20081, 20041
Nesco	20000
Neufunk	20209
Newave	20037
Nikkai	20278
Nikko	20037, 20278
Nikkodo	20037, 20278
Nishi	20240
Niveus Media	21972
Noblex	20240
Nokia	20048, 20081, 20240, 20042, 20104, 20041, 20278, 20046, 20106, 20315
Nordmende	20067, 20041, 20320
Northgate	21972
Nu-Tec	20209
Oceanic	20048, 20081, 20000, 20104, 20041, 20046, 20106
Okano	20209, 20278, 20315, 20348
Olympus	20035, 20162, 20104, 20226
Onimax	20642
Onkyo	20222
Optimus	21062, 20035, 20162, 20037, 20048, 20047, 20240, 20000, 20104, 20432, 21162, 21262
Orion	20184, 20240, 20000, 20104, 20121, 20209, 20002, 20278, 20348, 20352, 20479, 20742, 21479
Orson	20000
Osaki	20037, 20000
Otake	20209
Otto Versand	20081
Pace	20352
Pacific	20000, 20348, 20642, 20742
Packard Bell	21972
Palladium	20037, 20209, 20041, 20348
Palsonic	20000, 20642
Panama	20035
Panasonic	21062, 20035, 20162, 20000, 20225, 20226, 20614, 20616, 20836, 21035, 21162, 21262, 21562
Pathe Cinema	20043
Pathe Marconi	20041
Penney	20035, 20162, 20037, 20047, 20081, 20240, 20000, 20042, 20067, 20038, 21035, 21237
Pentax	20042
Perdio	20000, 20209
Philco	20035, 20081, 20000, 20209, 20038, 20226, 20479

Philips	20035, 20162, 20048, 20081, 20045, 20000, 20209, 20226, 20616, 20618, 20739, 21081, 21181
Phoenix	20278
Phonola	20081
Pilot	20037
Pioneer	20162, 20081, 20042, 20067
Polk Audio	20081
Portland	20278, 20637
Presidian	21593
Prinz	20000
Profitronic	20081, 20240
Proline	20000, 20278, 20320, 20642
Proscan	20060, 21060
Proscos	20278
Prosonic	20209, 20278
Protec	20000
Protech	20081
ProVision	20278
Pulsar	20039, 20240, 20278
Pulser	20240
Pye	20081, 20000
Qisheng	20060
Quarter	20046
Quartz	20035, 20047, 20046
Quasar	20035, 20162, 20002, 20278, 20226, 21035, 21162
Quelle	20081
Radialva	20037, 20048, 20081
Radiola	20081
Radionette	20037, 21137
RadioShack	20035, 20162, 20037, 20048, 20047, 20240, 20000, 20104, 20046, 21162
Radix	20037
Randex	20037
Rank	20041
Rank Arena	20041
RCA	20060, 20035, 20048, 20240, 20045, 20000, 20042, 20106, 20226, 20320, 20807, 20880, 21035, 21060
Realistic	20035, 20162, 20037, 20048, 20047, 20240, 20000, 20104, 20121, 20278, 20046, 21162
Reoc	20348
ReplayTV	20614, 20616
Rex	20041
Ricavision	21972
Rio	21137
Roadstar	20037, 20081, 20240, 20278, 20038, 20742
Runco	20039
Saba	20041, 20278, 20320
Saisho	20209, 20348
Salora	20104, 20043, 20046, 20106

Sampo	20037, 20048
Samsung	20060, 20240, 20045, 20000, 20038, 20432, 20739, 21014
Samtron	20240
Sanky	20048, 20039
Sansei	20048
Sansui	20240, 20000, 20067, 20209, 20041, 20002, 20106, 20348, 20479, 21479
Sanyo	20048, 20047, 20240, 20000, 20104, 20067, 20209, 20046, 20348, 20479, 21137
Saville	20240, 20278, 20352
SBR	20081
ScanSonic	20240
Schaub Lorenz	20000, 20104, 20041, 20106, 20315, 20348
Schneider	20037, 20081, 20240, 20000, 20042, 20278, 20348, 20352, 20642, 21137
Scott	20184, 20045, 20121, 20043
Sears	20060, 20035, 20162, 20037, 20048, 20039, 20047, 20033, 20045, 20000, 20042, 20104, 20067, 20043, 20209, 20041, 21237, 20046
Seaway	20278
SEG	20081, 20240, 20278, 20637, 20642
SEI	20081
Sei-Sinudyne	20081
Seleco	20037, 20041
Semp	20045
Sentra	20278
Sharp	20037, 20048, 20047, 20032, 20000, 20209, 20807
Shinco	20000
Shintom	20039, 20240, 20000, 20104
Shivaki	20037
Shogun	20240
Siemens	20037, 20081, 20104, 20046, 20320, 20347
Siera	20081
Signature	20060, 20035, 20037, 20048, 20000, 20046, 20479
Silva	20037
Silver	20278
SilverCrest	20642
Singer	20037, 20240, 20045, 20348
Sinudyne	20081, 20209, 20352
Smaragd	20348
Sonic Blue	20614, 20616, 21137
Sonographe	20046
Sonolor	20048, 20046
Sontec	20037, 20278
Sonwa	20642
Sony	20035, 20048, 20047, 20032, 20033, 20000, 20067, 20046, 20106, 20226, 20636, 21232, 21972

Soundmaster	20000
Soundwave	20037, 20209, 20348
Stack 9	21972
Standard	20278
Stern	20278
STS	20042
Sunkai	20209, 20278, 20348
Sunstar	20000
Suntronic	20000
Supra	20037, 20278, 20348
Susumu	20037
SV2000	20000
SVA	20000
Sylvania	20035, 20081, 20000, 20043, 21593, 21781
Symphonic	20240, 20000, 20002, 21593
Systemax	21972
T+A	20162
Tagar Systems	21972
Taisho	20209
Tandberg	20278
Tandy	20000, 20104
Tashiko	20037, 20048, 20081, 20240, 20000
Tatung	20048, 20081, 20045, 20000, 20067, 20043, 20209, 20041, 20348, 20352
Tchibo	20348
TCM	20348
Teac	20037, 20000, 20067, 20041, 20278, 20637, 20642, 21593
Technics	20035, 20162, 20037, 20081, 20000, 20226, 21162
TechniSat	20348
Technosonic	20352
Teco	20035, 20037, 20048, 20041, 20038
Tedex	20037, 20209, 20348, 20642
Teknika	20035, 20037, 20000
Teleavia	20041
Telecorder	20240
Telefunken	20209, 20041, 20278, 20320, 20642
Telerent	20226
Telesat	20037
Teletech	20000, 20278
Tensai	20037, 20000, 20278
Tevion	20209, 20348, 20479, 20642
Textet	20278
Thomas	20000, 20002
Thomson	20060, 20067, 20041, 20278, 20320
Thorn	20037, 20104, 20041, 20320
Tisonic	20278
Tivo	20618, 20636, 20739, 21996
TMK	20240, 20000

TNIX	20037
Tocom	20240
Tokai	20037, 20104, 20041
Topline	20348
Toshiba	20081, 20240, 20045, 20000, 20042, 20067, 20043, 20209, 20041, 20352, 20432, 20742, 20845, 21008, 21145, 21972, 21996
Tosonic	20278
Totevision	20037, 20240
Touch	21972
Toyoda	20278
Tradex	20081
Triad	20278
Trix	20037
<b>U</b> Uher	20240
Ultra	20045, 20278
Ultravox	20278
Unitech	20240
United	20348, 20742, 21593
Universum	20037, 20081, 20240, 20000, 20104, 20209, 20106, 20348, 21137
<b>V</b> Vector	20045
Vector Research	20184, 20038
Victor	20067, 20041
Video Concepts	20045
Video Technic	20000
Videomagic	20037
Videosonic	20240, 20000
Viewsonic	21972
Villain	20000
Voodoo	21972
Wards	20060, 20035, 20037, 20048, 20039, 20047, 20081, 20033, 20240, 20045, 20000, 20042, 20043, 20041, 20038, 20046, 20479
Watson	20081, 20352, 20642
Weltblick	20037
Wharfedale	20642
White Westinghouse	20000, 20209, 20278, 20479, 20637
World	20209, 20002, 20348, 20479
<b>X</b> XR-1000	20035, 20240, 20000
<b>Y</b> Yamaha	20041, 20038
Yamishi	20278
Yoko	20037, 20240
Zenith	20037, 20039, 20033, 20000, 20209, 20041, 20278, 20479, 20637, 21137, 21479
ZT Group	21972
ZX	20209, 20348, 20352

<b>PVR</b> ※3	
<b>A</b> ABS	21972
Alienware	21972
<b>C</b> CyberPower	21972
<b>D</b> Dell	21972
DirectTV	20739
<b>G</b> Gateway	21972
Go Video	20614
<b>H</b> Hewlett Packard	21972
Howard Computers	21972
HP	21972
Hughes Network Systems	20739
Humax	20739
Hush	21972
<b>I</b> iBUYPOWER	21972
<b>L</b> Linksys	21972
<b>M</b> Media Center PC	21972
Microsoft	21972
Mind	21972
<b>N</b> Niveus Media	21972
Northgate	21972
<b>P</b> Panasonic	20614, 20616
Philips	20618, 20739
<b>R</b> RCA	20880
ReplayTV	20614, 20616
<b>S</b> Samsung	20739
Sonic Blue	20614, 20616
Sony	20636, 21972
Stack 9	21972
Systemax	21972
<b>T</b> Tagar Systems	21972
Tivo	20618, 20636, 20739
Toshiba	21008, 21972, 21996
Touch	21972
<b>V</b> Viewsonic	21972
Voodoo	21972
<b>Z</b> ZT Group	21972

<b>DVD Player</b>	
<b>1</b> 3D LAB	30503, 30539
4Kus	31158
<b>A</b> A-Trend	30714
Acoustic Solutions	30713, 30730, 31228
AEG	30770, 30788, 30790, 31923
AFK	31051, 31152, 31923
Aim	30672, 30699, 30833
Airis	30672, 31005, 31224, 31250, 31321, 31345
Aiwa	30533, 30641

Akai	30690, 30695, 30705, 30770, 30788, 30790, 30884, 30898, 30899, 31115, 31205, 31233, 31695
Akashi	30838
AKI	31005
Akira	30699, 31321
Akura	30898, 31051, 31140, 31233, 31367
Alba	30672, 30539, 30717, 30695, 30699, 30713, 30730, 30783, 30884, 31140, 31530, 31695
Alco	30790
Alize	31151
All-Tel	31451
Allegro	30869
Altacom	31224
Amitech	30784, 30770, 30850
Amoi	30852
Amphion Media Works	30872
Amstrad	30713, 30770, 31151, 31367
AMW	30872
Anam	31913
Ansonic	30759, 30774, 30831
Apex Digital	30533, 30672, 30717, 30755, 30794, 30796, 30797, 30830, 31004, 31020, 31056, 31061
Aristona	30539, 30646
Arrgo	31023
ASCOMTEC	31923
Asono	31224
Aspire Digital	31168
Atacom	31224
Audiosonic	30690, 31923
Audiovox	30717, 30790
Audioworld	30790
Autovox	30713
Avvio	30843
Awa	30730, 30872
Axion	30730
<b>B</b> Base	31451
Basic Line	30713
Baze	30898
BBK	30862, 31224
Beep	31163
Bellagio	31004
Belson	31086, 31923
Binatone	31923
Black Diamond	30713, 30833, 30884
Blaupunkt	30717
Blusens	31233, 31321
Blue Nova International	31321
Blue Parade	30571

Blue Sky	30672, 30651, 30695, 30699, 30713, 30790, 30843, 31423
Boghe	31004
Boman	30783, 30898, 31005
Bose	32023
Brainwave	30770, 31115
Brandt	30503, 30651, 30551
Broksonic	30695
Bush	30672, 30717, 30690, 30699, 30713, 30723, 30730, 30831, 30833, 30884, 31051, 31140, 31483, 31695, 31832
Byd:sign	30872
<b>C</b> C-Tech	30798, 31152
California Audio Labs	30490
Cambridge Audio	30751, 31109
Cambridge Soundworks	30690
Campomatic Digital	31051
Cat	30699, 30789, 31421, 31923
CCE	30730
Celestial	31020
cello	31730
Centrex	30672, 31004
Centrum	30713, 30789, 31005, 31227, 31923
CGV	30751, 31115
Changhong	30627, 31061
Cinea	30831, 30841
Cinetec	30713, 30872
cineULTRA	30699
CineVision	30833, 30869, 31483
Citizen	30695
Clairtone	30571
Classic	30730, 31730
Clatronic	30672, 30675, 30788, 31233
Clayton	30713
Coby	30730, 30852, 31086, 31321, 31923
Codex	31233
Commax	31321
Conia	30672, 30852, 31321
Contel	30788
Continental Edison	30831, 30872
Craig	30831
Creative	30503, 30539
Crown	30690, 30713, 30770, 31115
Crypto	31228
Curtis Mathes	31087
Cybercom	30831
CyberHome	30714, 30816, 30874, 31023, 31024, 31117, 31129, 31502
Cytron	30651, 30705, 30774, 31347
<b>D</b> D-Vision	31115, 31367
Daenyx	30872

Daewoo	30490, 30784, 30705, 30714, 30770, 30833, 30869, 30872, 31172, 31483, 31906
Dalton	31036
Dansai	30770, 30783, 31115, 31695
Dantax	30539, 30713, 30723, 30790
Daytek	30872, 31005
Dayton	30872
DCE	30831
Decca	30770, 31115
Denon	30490, 30634, 31634, [32134]*
Denver	30672, 30699, 30788, 30898, 31056, 31104, 31321, 31923
Denzel	30665
Desay	30843, 31212
Dgtec	30672
Diamond	30651, 30751, 30768, 30790
Digihome	30713
DigiLogic	30713
digiRED	30717
Digitech	31832
Digitor	30651, 30690, 30833, 31005, 31423
Digitrex	30672, 31004, 31056
DiK	30831
Dinamic	30788
Disney	30675, 30831, 31270
DiViDo	30705
DK Digital	30831
DMTech	30783, 31271
Dragon	30831
DreamX	31151
DSE	30833, 31152, 31730
Dual	30651, 30665, 30675, 30713, 30730, 30783, 30790, 30831, 31023
Durabrand	30713, 30831, 31023, 31502
DVD2000	30521
DVX	30768
<b>E</b> E:max	31233, 31321
EagleTec	30714
eBench	31152
ECC	30730
Eclipse	30723, 30751
Elfunk	30713, 30850, 30884
Elin	30770
Elite	31152
Ellion	30850, 31421
Elta	30672, 30690, 30770, 30788, 30850, 31051, 31115, 31151, 31233
Eltax	31233, 31321
Emerson	30591, 30675, 30705, 30821, 31268
Enterprise	30591

Entivo	30503, 30539
Enzer	30784, 30770, 31228
ESA	30821, 31268
EuroLine	30675, 30788, 31115, 31233
<b>F</b> Fenner	30651
Ferguson	30651, 30695, 30713, 30884, 30898, 31695, 31730
Finlux	30672, 30591, 30741, 30751, 30770, 30783
Firstline	30651, 30713, 30843, 30869, 31530
Fisher	30670
Funai	30675, 30695, 31268
Fusion	30862
<b>G</b> Gateway	31158
GE	30522, 30815, 30717
General Electric	30717
Germatic	31051
Global Link	31224
Global Solutions	30768
Global Sphere	31152
Go Video	30573, 30744, 30717, 30715, 30741, 30783, 30833, 30869, 31044, 31075, 31099, 31158, 31483, 31730
GoldStar	30591, 30741, 30869
Goodmans	30651, 30690, 30713, 30723, 30730, 30783, 30790, 30833, 31004, 31140, 31423, 31530, 31730, 31923
GP Audio	31140
GPX	30699, 30741
Gradiente	30490, 30651
Graetz	30665
Gran Prix	30831, 30898
Grandin	30713, 31233
Greenhill	30717
Grundig	30539, 30651, 30551, 30670, 30686, 30695, 30705, 30713, 30775, 30790, 31004, 31036, 31695, 31730, 31832, 31920
Grunkel	30770, 30790, 30831
<b>H</b> H & B	30713, 30841, 30850, 31233, 31421
Haaz	30751, 31152
Haier	30843
Hanseatic	30741, 30783, 30790
Harman/Kardon	30582, 30702
HCM	30788
HDT	30705
HE	30730, 31163, 31923
Henss	30713
HiMAX	30843
Hitachi	30573, 30664, 30665, 30713, 31247, 31920
Hiteker	30672, 31923
Hoeher	30651, 30713, 30831, 31004, 31224

Home Electronics	30730, 30770
Home Tech Industries	31224
Hoyo	30665
Humax	30646
Hyundai	30783, 30850, 31061, 31228
<b>I</b> iLo	31348
Ingelen	30788
Ingersol	31023
Initial	30839, 30717
Inno Hit	30713
Insignia	31268
Integra	30571, 30627, 31634
Irradio	30869, 31115, 31224, 31233
IRT	30783
ISP	30695
<b>J</b> Jamo	31036
Jaton	30665
JBL	30702
JDB	30730
JDV	31367
Jeken	30699
Jepssen	31250
JMB	30695
JNC	30672, 31271
JSI	31423
JVC	30503, 30539, 30558, 30623, 30867, 31164, 31597, 31860
jWin	31051
<b>K</b> Kansas Technologies	31233, 31530
Karcher	30783
Kawasaki	30790
Kendo	30672, 30699, 30713, 30831
Kennex	30713, 30770, 30898
Kenwood	30490, 30534
Kiiri	30770
Kiss	30665, 30841, 31523
KLH	30815, 30717, 30790, 31020
Kloss	30533
Koda	31230
Konka	31192
Koss	30651, 31061, 31423
Kreisen	31421
KXD	31321, 31923
<b>L</b> Lasonic	30627, 30798, 30789
Lawson	30768
Lecson	31533
Leiker	30872
Lenco	30651, 30699, 30713, 30770, 30774
Lenoir	31228
Lenoxx	30690, 30838
Lexia	30699, 30768

LG	30591, 30741, 30790, 30869, 31906
Lifetec	30651, 30831, 31347
Limit	30768, 31104
LiteOn	31058, 31158
Lodos	30713
Loewe	30539, 30511, 30741, 30885
Logik	30713, 30884
Logix	30705, 30783
Luker	31367
Lumatron	30695, 30705, 30713, 30741, 30833, 31115, 31321, 31832
Lunatron	30741
Luxman	30573
Luxor	30713, 31004, 31695, 31730
<b>M</b> Magnasonic	30651, 30675
Magnat	31923
Magnavox	30503, 30539, 30646, 30675, 30713, 30821, 30885, 31140, 31268
Magnex	30723
Majestic	31345
Manhattan	30705, 30713
Marantz	30503, 30539, 30675
Mark	30713
Marquant	30770
Matsui	30672, 30651, 30695, 30713, 30884, 31004, 31695, 31730
Maxdorf	30788
Maxent	31347
Maxim	30713, 30872, 31367
Maya	31345
MBO	30690, 30730, 31730
McIntosh	31533
MDS	30713
Mecotek	30770
Medion	30651, 30630, 30774, 30783, 30831, 31006, 31270, 31345, 31347, 31423
MEI	30790
Memorex	30690, 30695, 30831, 31270
Metronic	30690
Metz	30525, 30571, 30713
MiCO	30723, 30751, 31223
Micromaxx	31695
Micromedia	30503, 30539
Micromega	30539, 31005
Microsoft	30522, 31708
Microstar	30831
Minato	30752
Minax	30713
Minerva	30705
Minoka	30770, 31115
Mintek	30839, 30717
Mirror	30752

Mitsubishi	31521, 30521, 30713, 31403
Mizuda	30770, 31451
Monyka	30665
MPX	30843
Mustek	30730, 31730
Mx Onda	30651, 30751, 31223
Mystral	30831
<b>N</b> NAD	30741
Naiko	30770, 31004, 31367
Narita	31367
NEC	30741, 30869, 31404
Neovia	31271
Nesa	30717
Neufunk	30665
Nevir	30770, 30831, 31197
NexxTech	31402
Nikkai	31923
Nintaus	31051, 31202
Niro	32024
Norcent	30872, 31923
Nordmende	30774, 30831
Noriko	30752
Nova	31923
Nowa	30843
Nu-Tec	31228
<b>O</b> Okano	30752
Olidata	30672
Omni	30690, 30833, 30838, 30862, 31104, 31832
Onix	30838
Onkyo	30503, 30627
Oopla	31158
Oppo	31224
Optim	30843
Optimus	30525, 30571
Orbit	30872
Orion	30695, 31233, 31695
Oritron	30651
Ormond	30713
<b>P</b> P&B	31451
Pacific	30695, 30713, 30759, 30768, 30790, 30831
Packard Bell	30831
Palladium	30695, 30713, 31906, 31920
Palsonic	30672, 30852, 31056, 31321
Panasonic	30503, 30490, 30571, 30703, 31362, 31462, 31490, 31579, 31762, 31834, 31905, 31908
Panda	30717, 30789, 31203
peekTon	30898, 31224
Philco	30690, 30862
Philips	30503, 30539, 30646, 30675, 30854, 30885, 31158, 31260, 31267, 31340, 31354

Philo	31345
Phonotrend	30699
PianoDisc	31024
Pioneer	30490, 30525, 30571, 30631, 31965
Plu2	30850
Pointer	30784
Polaroid	31020, 31061, 31086
Polk Audio	30539
Portland	30770
Powerpoint	30872, 31005
Presidian	30675
Prima	31228
Prinz	30831
Prism	30705, 30831
Pro2	31345
ProCaster	31004
Proceed	30672
Proline	30672, 30651, 30686, 30833, 31004, 31483
Proscan	30522
Proson	30713
Prosonic	30699, 30752
ProVision	30699, 30730, 31163, 31321, 31923
Pye	30539, 30646
<b>Q</b> QONIX	31051
Qwestar	30651
<b>R</b> Radionette	30741, 30869, 31906, 32024
RadioShack	30571
Raite	30665
RCA	30522, 30571, 30717, 30790, 30822, 31022, 31132, 31769, 31913, 31965
Realistic	30571
REC	30490
Redstar	30759, 30763, 30770, 30788, 30898, 31345, 31923
Relisys	31347
Reoc	30752, 30768
Revoy	30699, 30841
Rex	30838
Richmond	31233
Rio	30869
Roadstar	30672, 30690, 30699, 30713, 30730, 30833, 30898, 31051, 31227
Rocksonic	30789
Ronin	30872
Rotel	30558, 30623
Rowa	30717, 30759, 30872, 31004
Rownsonic	30789
<b>S</b> Saba	30651, 3055
Sabaki	30798
Saivod	30759, 30831, 31367



Salora	30741
Sampo	30752, 31321, 31347
Samsung	30490, 30573, 30744, 30199, 30820, 30899, 31044, 31075, 31635, 31932
Sansui	30784, 30695, 30751, 30763, 30768, 31051, 31228, 31230, 31695, 31832
Sanyo	30670, 30675, 30695, 30713, 30873, 31228
Scan	30705, 30850
ScanMagic	30730, 31730
ScanSonic	31695
Schaub Lorenz	30770, 30788, 31115, 31151
Schneider	30539, 30646, 30651, 30705, 30713, 30774, 30783, 30788, 30790, 30831, 30869, 31367
Schwaiger	30752
Scientific Labs	30768
Scott	30672, 30651, 31005, 31036, 31233, 31423
Seeltech	31224, 31451
SEG	30798, 30665, 30713, 30763, 30872, 30884, 31483, 31530
Sensory Science	31158
Shanghai	30672
Sharp	30630, 30675, 30713, 30752, 31256, 32015, 32024
Sharper Image	31117
Sherwood	30717, 30741, 30770
Shinco	30717
Shinsonic	30533, 30839
Siemssen	31382
Sigmatek	31005, 31224
Siltex	31224
Silva	30788, 30898
Silva Schneider	30831, 30898
SilverCrest	31152
Simaudio	30885
Singer	30690, 30751, 30768
Sistemas	30672
Skantic	30539, 30713
Skymaster	30730, 30768
Skyworth	30898
Sliding	31115
Slim Art	30784
SM Electronic	30690, 30730, 30768, 31152
Smart	30705, 30713
Sonai	30755
Sonashi	30831
Sonic Blue	30573, 30715, 30783, 30869, 31099
Sony	30533, 31533, 30864, 30573, 30630, 30772, 31033, 31070, 31431, 31433, 31536, 31633, 31769, 31981, 32043
Sound Color	31233
Soundmaster	30768

Soundmax	30768
Soundwave	30783
Spectra	30872
Standard	30651, 30768, 30788, 30831, 30898
Star Clusters	31152, 31227
Starlogic	31005
Starmedia	31005, 31224
Stevison	31367
Strong	30713
Sunkai	30770, 30850
Sunstech	30831
Sunwood	30788, 30898
Superscan	30821
Supervision	30768, 31152
SVA	30672, 30717, 30752, 31105
Sylvania	30630, 30675, 30821, 31268
Symphonic	30675, 30821, 31268
Synn	30768
Tandberg	30713, 31695
Tangent	31321
Targa	31227
Tatung	30770, 31695
Tchibo	30741
TCL	31180
TCM	30741, 30790
Teac	30571, 30717, 30675, 30741, 30759, 30768, 30790, 30833, 31006, 31197, 31227
Tec	30898
Technica	31367, 31695
Technics	30490, 30703, 31905
Technika	30770, 30831, 31115, 31695
Technisson	31115
Technosonic	30730, 31051, 31115
Techwood	30713, 31530
Tedalex	30690, 30768, 31004, 31228
Telefunken	30789, 30790, 30833, 31483, 31832, 31923
Teletech	30713, 30768
Tensai	30651, 30690, 30770
Tevion	30651, 30798, 30768, 30833, 30898, 31036, 31227, 31347, 31382, 31483, 31730, 31923
Theta Digital	30571
Thomson	30522, 30511, 30551
Tivo	31503
Tokai	30784, 30665, 30788, 30790, 30898
Tom-Tec	30789
Top Suxess	31224
Toshiba	30503, 30573, 30539, 30695, 31045, 31154, 31503, 31510, 31769
TRANS-continents	30831, 30872, 31321, 31327
Transonic	30730

Tredex	30843
TruVision	31451
Tsinghua Tongfang	31205
TSM	31224
Umax	30690, 31151
Unimax	30770
United	30675, 30695, 30699, 30713, 30730, 30788, 30884, 31115, 31152, 31228, 31367, 31832
Universum	30591, 30713, 30741, 30790, 30869, 31227, 31530, 31913
Uptek	30763
upXus	31345
Urban Concepts	30503, 30539
US Logic	30839
Venturer	30790
Vestel	30713, 30884, 31530
Victor	31597
Vieta	30705
Viewmaster	30862, 31224
Voxson	30690, 30730, 30774, 30831
Vtrek	31228
Waitec	31151, 31224, 31233
Walkvision	30717
Waltham	31530
Welkin	30831
Wellington	30713
Weltstar	30713
Wesder	30699
Wharfedale	30686, 30751, 30752, 30790, 31832
Wilson	30831, 31233
Windsor	30713
Windy Sam	30573
WIZE	31115
Woxter	31005, 31151, 31224
Xbox	30522, 31708
Xenius	30790
XLogic	30768, 31152, 31228
XMS	30770, 30788
Xoro	31183, 31250
Yakumo	31004, 31056
Yamada	30872, 31004, 31056, 31151, 31158
Yamaha	30490, 30539, 30646, 30545, 31354
Yamakawa	30665, 30872, 31104
Yukai	30730, 31730
Zenith	30503, 30591, 30741, 30869, 31906
Zeus	30784

## DVD Recorder

<b>1</b> 4Kus	31158
---------------	-------

<b>A</b> Airis	31321
Akira	31321
Alba	31530
Apex Digital	31056
Aristona	30646
Aspire Digital	31168
Belson	31086
Cat	31421
cello	31730
Centrum	31227
Classic	31730
Coby	31086
Commax	31321
Conia	31321
CyberHome	31129, 31502
Cytron	31347
Denon	30490
Denver	31056
Digitrex	31056
DSE	31730
Durabrand	31502
E:max	31321
Ellion	31421
Eltax	31321
Emerson	30675
Ferguson	31730
Firstline	31530
Funai	30675
Gateway	31158
Go Video	30741, 31158, 31730
Goodmans	31530, 31730
GPX	30741
Grundig	31730
H & B	31421
Humax	30646
iLo	31348
JVC	31164, 31597
Kansas Technologies	31530
Kreisen	31421
KXD	31321
LG	30741
Lifetec	31347
LiteOn	31158
Loewe	30741
Lumatron	31321
Luxor	31730
Magnavox	30646, 30675
Matsui	31730
Maxent	31347
MBO	31730
Medion	31347
MiCO	30751

Mitsubishi	31403
Mustek	31730
<b>N</b> NEC	31404
<b>O</b> Oopla	31158
<b>P</b> Palsonic	31056, 31321
Panasonic	30490, 31579
Philips	30646, 31158
Pioneer	30631
Polaroid	31086
ProVision	31321
Pye	30646
<b>R</b> RCA	30522
Relisys	31347
Roadstar	31227
<b>S</b> Sampo	31347
Samsung	30490, 31635
ScanMagic	31730
Schneider	30646
SEG	31530
Sensory Science	31158
Sharp	30630, 30675
Sony	31033, 31070, 31431, 31433, 31536
Star Clusters	31227
Sylvania	30675
<b>T</b> Tangent	31321
Targa	31227
Teac	31227
Techwood	31530
Tevion	31227, 31347, 31730
Thomson	30551
Toshiba	31510
<b>U</b> Universum	31227, 31530
<b>V</b> Vestel	31530
Victor	31597
<b>W</b> Waltham	31530
<b>Y</b> Yakumo	31056
Yamada	31056, 31158
Yamaha	30646
Yukai	31730
<b>Z</b> Zenith	30741

DVD preset codes DVD-Voreinstellungscodes Codes pré-réglés DVD Codici di preselezione DVD Códigos de preajuste de DVD DVD-voorkeuzecodes Förinställda DVD-koder	32134		30490
DENON			
Model No.	DVD-550	DVD-2800II	DVD-800
Modellnr	DVD-700	DVD-2900	DVD-1600
Modèle numéro	DVD-900	DVD-2910	DVD-2000
Modello No	DVD-1000	DVD-2930	DVD-2500
Nº de modelo	DVD-1400	DVD-3800	DVD-3000
Modelnr	DVD-1500	DVD-3910	DVD-3300
Modellnr	DVD-1710	DVD-3930	
	DVD-1910	DVD-A11	
	DVD-1930	DVD-A1	
	DVD-2200	DVD-A1XV	
	DVD-2800		

※1 : These preset codes can be recorded in the SAT/CBL mode.  
 : Diese voreingestellten Codes können im SAT/CBL-Modus aufgenommen werden.  
 : Ces codes de présélection peuvent être enregistrés en mode SAT/CBL.  
 : I codici preimpostati possono essere registrati nel modo SAT/CBL.  
 : Es posible guardar estos códigos preajustados en el modo SAT/CBL.  
 : Deze voorkeuzecodes kunnen worden opgenomen in de SAT/CBL-modus.  
 : Dessa förinställningskoder kan lagras i SAT/CBL-läget.

※2 : These preset codes can be recorded in the TV mode.  
 : Diese voreingestellten Codes können im TV-Modus aufgenommen werden.  
 : Ces codes de présélection peuvent être enregistrés en mode TV.  
 : I codici preimpostati possono essere registrati nel modo TV.  
 : Es posible guardar estos códigos preajustados en el modo TV.  
 : Deze voorkeuzecodes kunnen worden opgenomen in de TV-modus.  
 : Dessa förinställningskoder kan lagras i TV-läget.

※3 : These preset codes can be recorded in the VCR mode.  
 : Diese voreingestellten Codes können im VCR-Modus aufgenommen werden.  
 : Ces codes de présélection peuvent être enregistrés en mode VCR.  
 : I codici preimpostati possono essere registrati nel modo VCR.  
 : Es posible guardar estos códigos preajustados en el modo VCR.  
 : Deze voorkeuzecodes kunnen worden opgenomen in de VCR-modus.  
 : Dessa förinställningskoder kan lagras i VCR-läget.

※4 : These preset codes can be recorded in the DVD mode.  
 : Diese voreingestellten Codes können im DVD-Modus aufgenommen werden.  
 : Ces codes de présélection peuvent être enregistrés en mode DVD.  
 : I codici preimpostati possono essere registrati nel modo DVD.  
 : Es posible guardar estos códigos preajustados en el modo DVD.  
 : Deze voorkeuzecodes kunnen worden opgenomen in de DVD-modus.  
 : Dessa förinställningskoder kan lagras i DVD-läget.

- [ ]\* : Preset codes set upon shipment from the factory.  
 : Sie Voreinstellungscodes wurden vor der Auslieferung werkseitig eingestellt.  
 : Les codes pré-réglés diffèrent en fonction des livraisons de l'usine.  
 : I codici di preimpostazione sono impostati in fabbrica prima della consegna.  
 : Los códigos vienen preprogramados de fábrica.  
 : Voorinstelde codes bij het verlaten van de fabriek.  
 : Förinställda koder har ställts in vid transporten från fabriken.



**DENON**

[www.denon.com](http://www.denon.com)

Denon Brand Company, D&M Holdings Inc.  
Printed in Japan 00D 511 4672 002