

DENON®

DCD-1600NE

SUPER AUDIO CD PLAYER

Quick Start Guide

Kurzanleitung / Guide de démarrage rapide / Guida di Avvio Rapido /
Guía de inicio rápido / Snelhandleiding / Snabbstartsguide /
Краткое руководство пользователя / Skrócona instrukcja obsługi

Read Me First....

Bitte zuerst lesen... / Lisez-moi en premier... / Nota preliminare... /
Lea esto primero... / Lees mij eerst... / Läs detta först... /
Прочитайте в первую очередь... / Przeczytaj to najpierw....

ENGLISH

DEUTSCH

FRANÇAIS

ITALIANO

ESPAÑOL

NEDERLANDS

SVENSKA

РУССКИЙ

POLSKI

Welcome

Thank you for choosing a Denon CD player. This guide provides step-by-step instructions for setting up your CD player.

Please do not return this unit to the store – call for assistance.









If you need help... :

If you need additional help in solving problems, contact Denon customer service in your area.



For details, see the Denon homepage. www.denon.com

Before You Begin

What's In the Box

Quick Start Guide		Power cord	
Owner's Manual		Remote control unit	
Safety Instructions		R03/AAA batteries	
CD player		Audio cable	

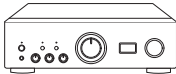
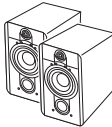
Required for Basic connections

		
Amplifier	Speaker systems	Speaker cables



These drawings are for illustrative purposes only and may not represent the actual product(s).

Setup

There are five steps to the setup process.

- 1** Install batteries in the remote control unit
- 2** Connect the CD player to the amplifier
- 3** Plug the power cord into a power outlet
- 4** Turn the CD player's power on
- 5** Begin CD or Super Audio CD playback

1 Install batteries in the remote control unit

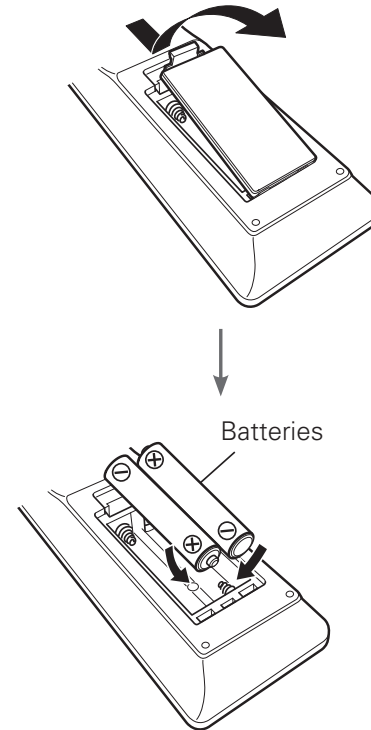

2 Connect the CD player to the amplifier

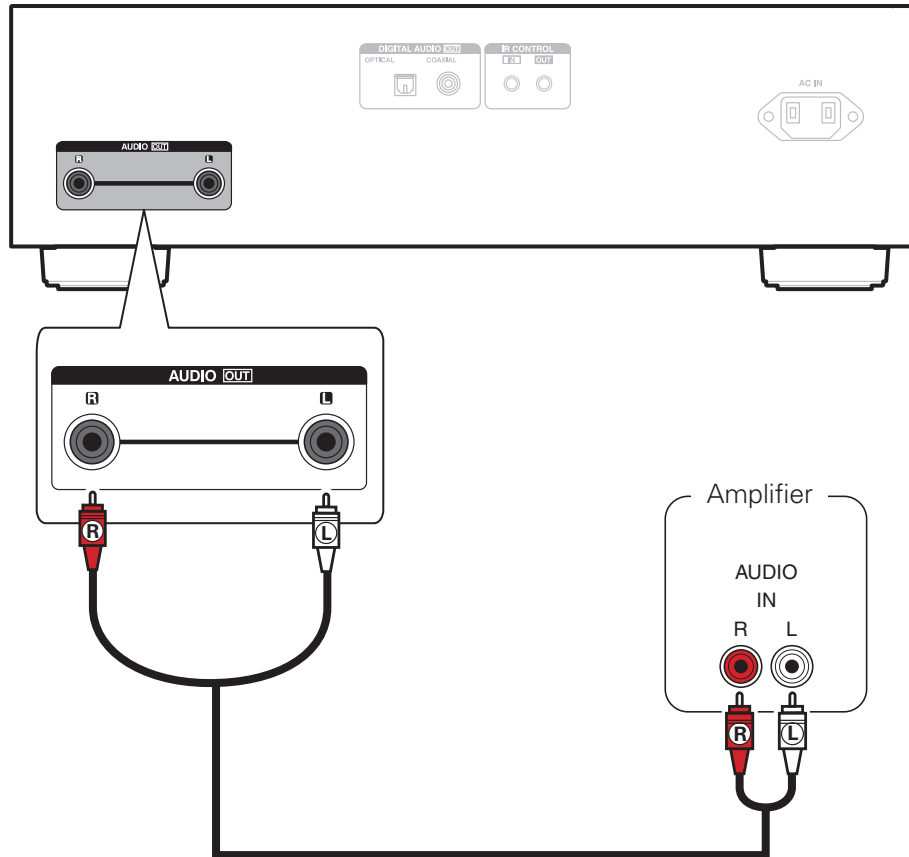

3 Plug the power cord into a power outlet

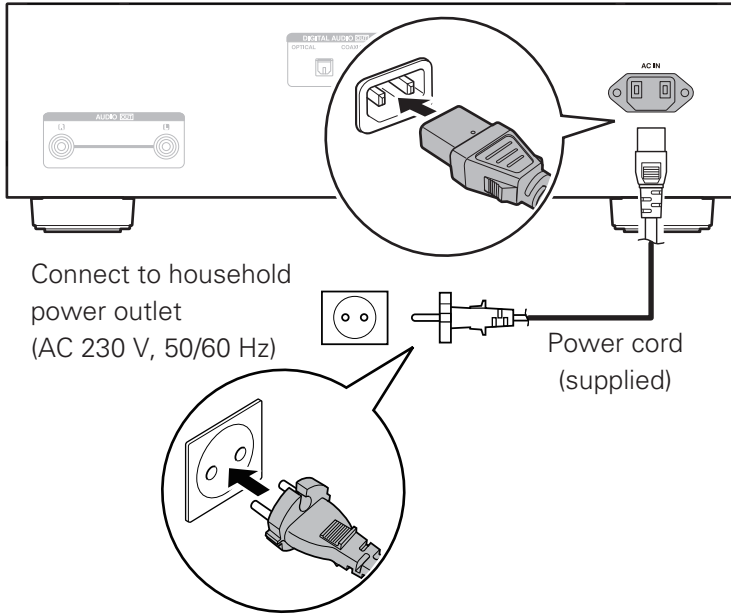

4 Turn the CD player's power on

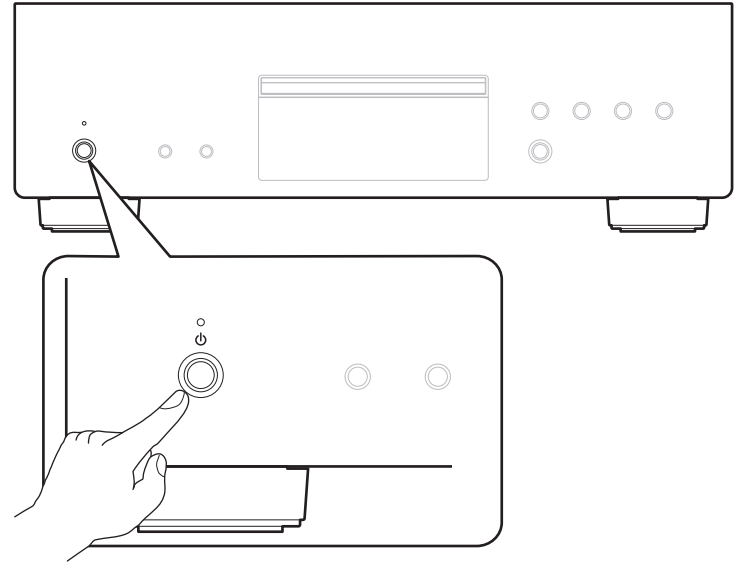

5 Begin CD or Super Audio CD playback

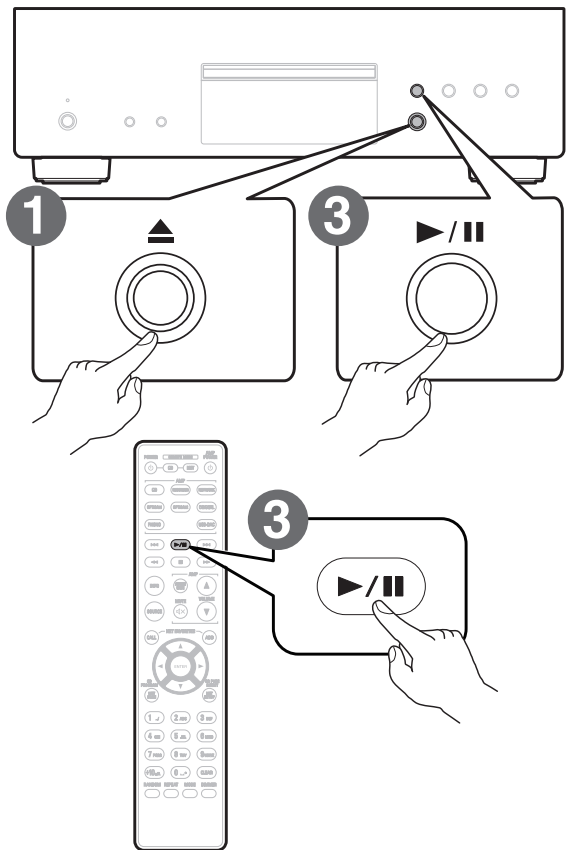

1 Press  to open the disc tray.

2 Place CD in the disc tray.

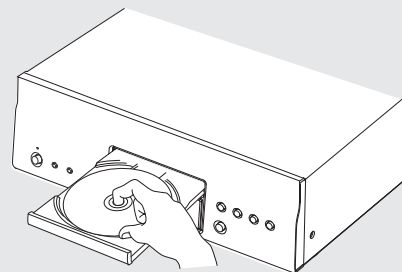

3 Press .
Playback starts.

Owner's Manual

Please reference to the Owner's Manual for more details about the setup and operation of the CD player and its features.

❑ Online Version

Enter the following URL into your web browser:
manuals.denon.com/DCD1600NE/EU/EN/

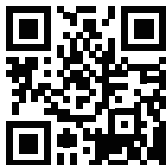

Online Manual



❑ Printable Version

Access the print version of the owner's manual from the included CD-ROM or select the "PDF Download" link from the Online Version.

1 Insert the disc into your PC.

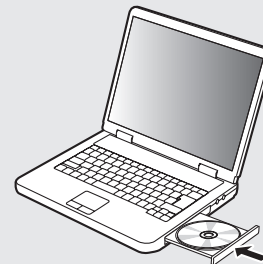

2 Follow the screen or double click on the PDF file.

DENON®

www.denon.com

Printed in Japan 5411 11435 00AD
Copyright © 2016 D&M Holdings Inc. All Rights Reserved.