

The First Name in Digital Audio

**DENON**

A/V SURROUND RECEIVER

**AVR-4800**

THX Ultra Certified  
2-channel Power Amplifier **POA-5200**



**DENON**

REMOTE SENSOR



ON / STANDBY



INPUT SELECTOR



HOME  
THX CINEMA



TAPE 2 MON



THX SURROUND EX

PHONES



DENON

INPUT SELECTOR

REMOTE SENSING



ON / STANDBY



HOME  
THX CINEMA



TAPE-2 MON



Personal Memory D-D-S-C

CH INDICATOR  
L C R LOCK  
BL S SR LFE

VOLUME LEVEL  
-15

THX 5.1 EX AUTO

SURROUND SPEAKER  
A B

PHONO CD TUNER DVD VDP TV/DBS VCR1 VCR2 V.MIX MD/TAPE1 TAPE2/MON



THX SURROUND EX

PHONES



5.1/7.1 SURROUND DIRECT STEREO DOLBY / DTS SURROUND SCH / J24 STEREO DSP SIMULATION SHIFT TUNING PRESET DOWN UP

INPUT MODE ANALOG BCL / ECH EXT. IN VIDEO SELECT TONE DEFEAT STATUS DIMMER MODE SOURCE

INPUT REC / MULTI

BASS



PRESERVE A.D.



A / V   S U R R O U N D   R E C E I V E R

# AVR-4800

## The World's First A/V Receiver with THX Surround EX

Denon's tradition of excellence and innovation in audio and home theater continues with the introduction of the AVR-4800, the world's first A/V receiver that combines Dolby Digital, DTS, Lucasfilm's THX Ultra 5.1 post-processing and also the newest surround technology, Lucasfilm's THX Surround EX decoding. Denon's history of world's firsts in digital A/V technology began in 1995 with the introduction of the AVP-8000, the first component to provide Dolby Digital decoding with Lucasfilm THX 5.1 post-processing, followed by the AVR-5600, the world's first A/V receiver with Dolby Digital and THX. The introduction in 1999 of the AVR-5700 brought together for the first time the combined technologies of Dolby Digital, DTS, and THX 5.1 in an A/V receiver.

Denon's newest A/V receiver, the AVR-4800, continues the AVR-5700's heritage of excellence and innovation by incorporating the newest surround technology - Lucasfilm's THX Surround EX decoding, and is another world's first for Denon. Optimized for the latest in DVD soundtracks and for future audio formats, the AVR-4800 brings a new level of sonic performance in home theater A/V receivers.

Providing 125 watts of power into each of the 5 amplifier channels, the AVR-4800's all-discrete power amplifier section features separates-quality design, providing power and detail with both music and movie soundtracks. From a whisper-quiet foundation to a thundering climax, the AVR-4800's power amp section delivers the full fidelity and authority of even the most demanding soundtracks and music performances.

Denon's Design Integrity philosophy is to develop components that faithfully reproduce the musician's artistry and the movie director's vision with total fidelity. The AVR-4800 is the latest in Denon's distinguished line-up of award-winning home theater components.



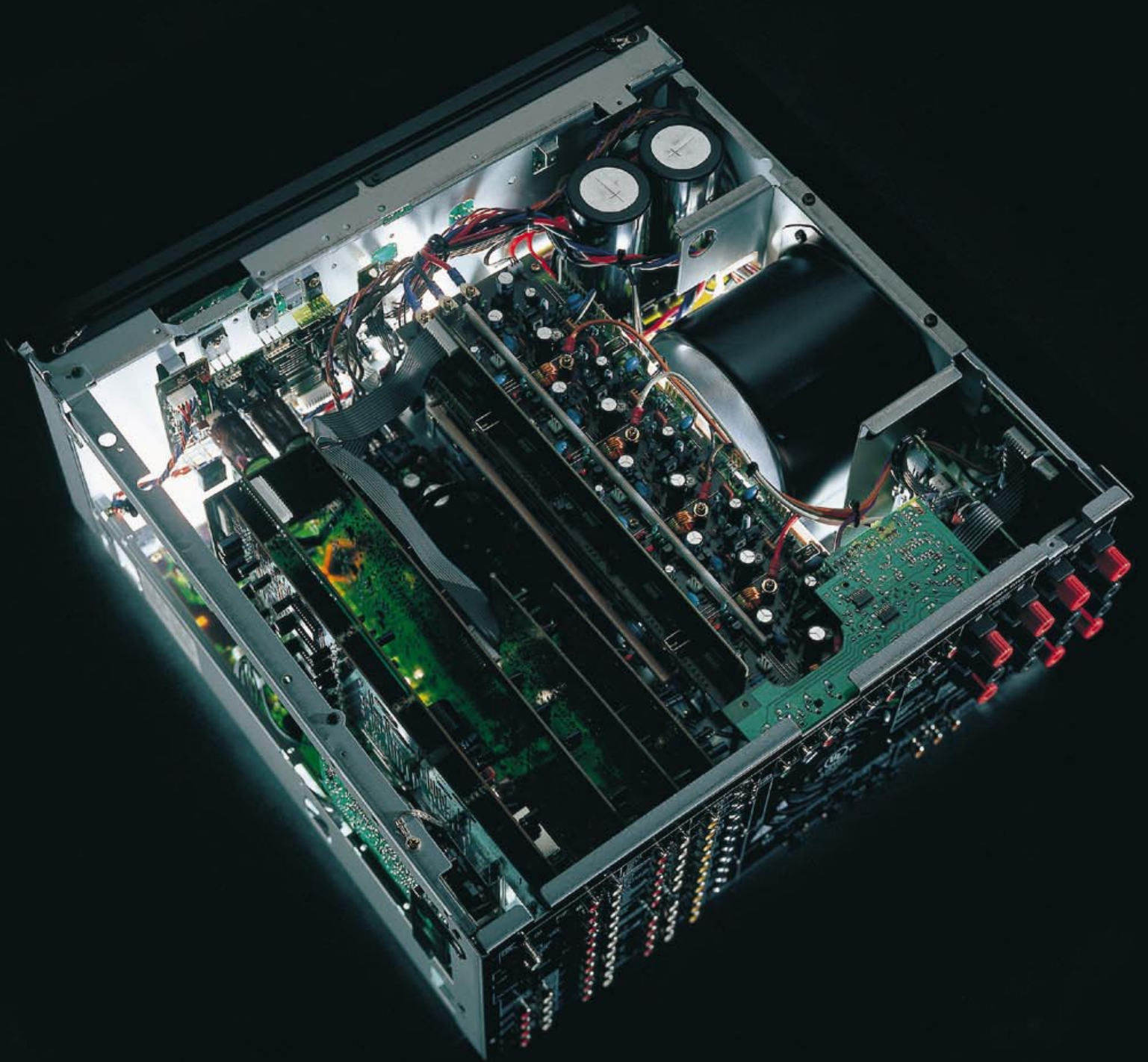

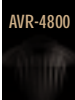

### ■ Discrete Power Amplifier Section with Equal Power and Equal Response In All Channels, Features THX Ultra Certification

The AVR-4800's all discrete power amp stage features high current, low distortion power output devices, able to drive virtually any modern loudspeaker system configuration, regardless of impedance or efficiency. Lucasfilm's most stringent THX Ultra certification provides your assurance that the AVR-4800 can deliver the full authority and dynamic impact of modern motion picture soundtracks in standard and large size home theater environments. The AVR-4800 is equipped with Denon's smart cooling system featuring a volume and temperature sensing fan, which provides necessary cooling during extended periods of high power operation, yet is completely inaudible and unobtrusive during quiet passages.

### ■ Robust Power Supply

The THX Ultra-certified power amp section is supplied with abundant reserves of energy due to the power supply's high current power transformer, and large capacity high current storage capacitors.

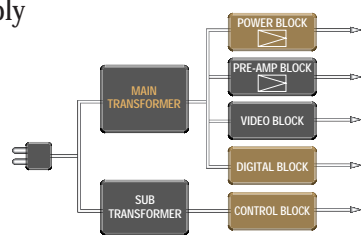

*Independent Power Transformers Block Diagram*

Individual separate power supplies are also provided for the low level analog and digital circuit blocks, to eliminate mutual interference. THX Ultra certification assures highest quality sound at virtually any volume level, from whisper quiet to thundering crescendo.

### ■ New D.D.S.C. (Dynamic Discrete Surround Circuit) - Digital

Denon's unique approach to surround decoder design, DDSC-Digital, employs optimized circuit blocks and elements for each individual surround decoder function, including highest performance analog-to-digital conversion stage featuring 20 bit precision, dedicated DSP processors featuring all-digital domain decoding. For the most accurate analog reproduction, the AVR-4800 features a stereo analog bypass mode, which preserves stereo analog purity and transparency, while providing digital bass management accuracy for optimum subwoofer response.

*Dynamic Discrete Surround Circuit-Digital Block Diagram*

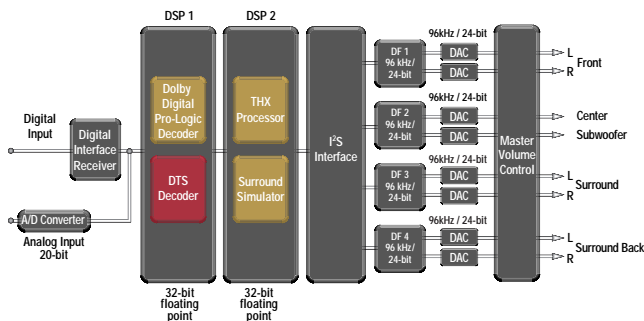

### ■ Dual Analog Devices SHARC 32 Bit Floating Point DSP

The heart of the AVR-4800's surround decoder section features two high speed 32 bit floating point DSP processors, same as used in the AVR-5700, bringing separates-quality surround decoding performance to the receiver category. The first DSP performs the Dolby Digital and DTS surround decoding, while the second DSP provides the THX post-processing, Surround EX decoding, other DSP environment simulations and bass management functions, all in digital domain with the highest accuracy possible.

### ■ 24 Bit, 96 kHz D/A Converters For All Channels

Unlike conventional A/V components that use integrated low-bit codecs, the AVR-4800 features highest quality multiple D/A converter chips. Featuring Analog Devices real 24 bit, 96 kHz D/A conversion on all audio channels, the AVR-4800 provides separates-quality D/A conversion performance.

### ■ THX Ultra & THX Surround EX, For Accurate Movie Soundtrack Reproduction

The AVR-4800 is the world's first A/V receiver to feature Lucasfilm's THX Ultra 5.1 post-processing along with the latest Lucasfilm THX Surround EX decoding function, providing the most accurate reproduction of the newest multi-channel motion picture soundtracks.

THX Surround EX, developed jointly by Lucasfilm and Dolby, made its debut in movie theaters with the release of the movie "Star Wars - Episode 1: The Phantom Menace". Featuring a specially-encoded 5.1 discrete soundtrack, the THX Surround EX function includes a center back surround channel in addition to the left surround and right surround channels, providing heightened spatial realism and more convincing surround imaging.

Now that Surround EX-encoded movies are available for home theater playback, the AVR-4800's THX Surround EX function provides thrilling home theater surround sound reproduction. Compared to simpler and less accurate "6.1" unlicensed simulations, the AVR-4800's accurate THX Surround EX decoding function provides the full suite of required decoding parameters, and can be automatically or manually selected, according to the program material characteristics.

In addition, the AVR-4800 surround decoder is DTS ES-compatible, along with accurate decoding of Dolby Digital and DTS 5.1 channel soundtracks, with or without THX 5.1 post-processing.

*THX Surround EX Processor Block Diagram*

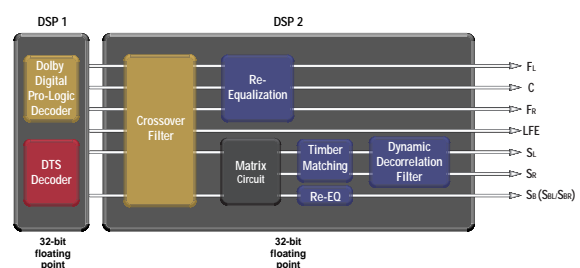

\*1. The AVR-4800 is equipped with a 5-channel amplifier. To hear the 6th and 7th channels used by Surround Back, you need to connect an external amplifier such as the DENON POA-5200. The signals for the additional channels are output through the Pre Out jacks.  
 \*2. When the Surround Back channel is turned off, the AVR-4800 processes the signals in the same manner and gives you the same effects as conventional 5.1-channel signals.



### ■ THX Surround EX Auto Mode

Surround EX-encoded movies may have a special data flag which will activate the AVR-4800 and set it automatically to THX Home Cinema mode with THX Surround EX decoding. Or, you can activate the THX Surround EX function manually, for program sources which do not have the special data flag.

### ■ Assignable Power Amplifier Configuration

The AVR-4800 provides 7.1 channel pre-amp outputs, to allow connection of external power amplifier(s), powered loudspeakers, and amplified subwoofer. To take full advantage of THX Surround EX, connect a mono or stereo amplifier to the surround back pre-amp outputs to drive the surround back loudspeaker(s). Or, use the AVR-4800 assignable power amp configuration to utilize the internal front left/right power amplifiers to drive the surround back speakers, and then connect an external stereo power amplifier, such as the Denon POA-5200, to the main left and right speakers. The AVR-4800 provides great system configuration flexibility.

### ■ Widescreen 7.1 Channel Playback of Conventional Sources - A Denon Original Technology

Denon's new Widescreen 7.1 function provides thrilling 7 speakers (plus subwoofer) reproduction of conventional stereo, matrix encoded, and discrete 5.1 program sources. This proprietary Denon DSP function provides full panoramic surround presentation, utilizing the three front loudspeakers, the two surround loudspeakers, and if configured, the surround back loudspeakers. Enjoy total 360 degree surround immersion, with movie soundtracks and your favorite musical performances also.

### ■ Dual Surround Mode Speaker Selection

Denon's exclusive Dual Surround Mode Speaker Selector provides two sets of surround speaker connections, for two different types of surround speakers and different placements in the home theater. Choose side-mounted diffuse surround speakers for the most realistic and enveloping movie soundtrack reproduction. Choose rear-mounted directional loudspeakers for the most accurate 5.1 channel music surround reproduction. Only Denon let's you choose the correct surround speaker type and placement, for movie and music surround without compromise.

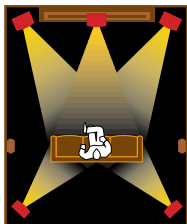

Music

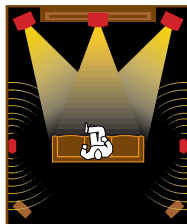

Movie

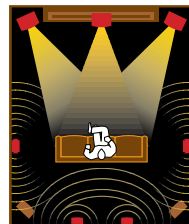

Surround back

### ■ 8 Channel External Inputs For Future Sound Format Upgrade Capability

A full set of 7.1 channel inputs is provided, for future multi-channel audio formats. The AVR-4800 is fully prepared for the future of multi-channel sound.

### ■ Component Video Switching Capability

In addition to the multiple composite and "S" video connections, the AVR-4800 provides DTV and progressive compatible component video inputs for the DVD and TV/DBS inputs, and a set of wideband component video outputs. The component video switching path is completely transparent, to ensure perfect video quality from even wideband high resolution video sources and high resolution video displays.

### ■ On Screen Display

Complicated operations are greatly simplified with the AVR-4800's on screen display, which lets you easily and quickly set the optimum system parameters for your home theater configuration.

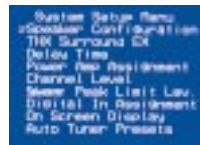

System Setup Menu



Easy setting of speaker configuration



User-friendly guide for making settings

### ■ Programmable Learning Remote with Installed IR Codes

The easy-to-use remote features important keys that are shaped and color-coded according to their function, and the remote provides learning capability to accept IR codes from other component's remotes. A built-in code library provides hundreds of codes for popular brands and models of equipment, and the important function keys are self-illuminating in the dark.

### ■ Multi-room Feature

The AVR-4800 is provided with a separate set of line-level output jacks, to connect an external amplifier or distribution component, so that you can enjoy a separate audio program in another part of the home. IR input and output ports accommodate external IR translators, repeaters, extenders, and other IR control components, for easy and versatile second zone control.

### ■ 40-Station AM/FM Random Preset Memory Tuning Auto Preset Memory (FM only)

### ■ Other Features

- Thoroughly Vibration-resistant Structure
- Tone Control Circuit (Front L/R, Center, Subwoofer)
- Record Output Selector

\*3. The THX Surround EX Auto Mode supports both Dolby Digital and DTS signal sources, and support for DVD and other program sources is planned.



**Input/Output Terminals For Every A/V System**

**Audio Inputs**

- 11 Sets Analog Input . . . . . PHONO, CD, TUNER, DVD, VDP, TV/DBS, V-AUX, VCR-1, VCR-2, MD/TAPE-1, TAPE-2
- 8-ch Analog EXT. Input . . . . . FRONT L/R, CENTER, SURROUND L/R, EFFECT L/R, SUBWOOFER
- 5 Sets Digital (Optical) Input . . . . . OPTICAL X 5
- 3 Sets Digital (Coaxial) Input . . . . . COAXIAL X 3

**Audio Outputs**

- 8-ch Analog PRE Output . . . . . FRONT L/R, CENTER, SURROUND L/R, EFFECT(SURROUND BACK) L/R, SUBWOOFER
- 4 Sets Analog REC Output . . . . . VCR-1, VCR-2, MD/TAPE-1, TAPE-2
- 1 Set Analog Multi Source Output . . . . . L/R
- 1 Set Digital (Optical) Output . . . . . OPTICAL

**Video Inputs**

- 2 Sets Component Video Input . . . . . DVD, TV/DBS
- 6 Sets Composite Input . . . . . DVD, VDP, TV/DBS, V-AUX, VCR-1, VCR-2
- 6 Sets S-Video Input . . . . . DVD, VDP, TV/DBS, V-AUX, VCR-1, VCR-2

**Video Outputs**

- 1 Set Component Video Output . . . . . MONITOR
- 4 Sets Composite Output . . . . . VCR-1, VCR-2, MONITOR-1, MONITOR-2
- 4 Sets S-Video Output . . . . . VCR-1, VCR-2, MONITOR-1, MONITOR-2

**Specifications**

**Power Amplifier Section**

- Rated output . . . . . \*THD figures are power amp stage values.
- Front / Center / Surround . . . . . 125 W x 2 / 125 W / 125 W x 2 (8 ohms, 20Hz - 20kHz, 0.05% THD)
- . . . . . 150 W x 2 / 150 W / 150W x 2 (6 ohms, 20Hz - 20kHz, 0.08% THD)

**Preamplifier Section**

- Input sensitivity/Impedance
- PHONO(MM) . . . . . 2.5 mV/47 kohms
- CD, DVD, VDP, TV/DBS, V-AUX, VCR-1 VCR-2, MD/TAPE-1, TAPE-2, FRONT L/R, CENTER, SURROUND L/R, EFFECT L/R, SUBWOOFER . . . . . 200 mV/47 kohms
- Output level/Load Impedance
- FRONT L/R, CENTER, SURROUND L/R, EFFECT (SURROUND BACK) L/R, SUBWOOFER . . . . . 1.2 V/10 kohms
- V-AUX, VCR-1 VCR-2, MD/TAPE-1, TAPE-2, MONITOR . . . . . 200 mV/47 kohms
- RIAA deviation . . . . . ±1 dB (20 Hz - 20 kHz)
- Tone control . . . . . Treble: ±10 dB at 10 kHz Bass: ±10 dB at 100 Hz

**FM Section**

- Tuning frequency range . . . . . 87.5 - 107.9 MHz
- Usable sensitivity . . . . . 1.0 µV (11.2 dBf)

**AM Section**

- Tuning frequency range . . . . . 520 - 1710 kHz
- Usable sensitivity . . . . . 18 µV

**General**

- Power supply . . . . . AC 120 V, 60 Hz
- Power consumption . . . . . 10.9 A
- Dimensions . . . . . 434 (W) x 181 (H) x 494 (D) mm
- . . . . . 17.1" (W) x 7.1"(H) x 19.4"(D)
- Weight . . . . . 21.5 kg, 47.4 lbs



THX Ultra Certified 2-channel Power Amplifier

# POA-5200

The POA-5200 dual monaural power amplifier provides superb stereo reproduction, and is an ideal choice for adding additional amplifier channels to a multi-channel system. For example, when combined with Denon's AVR-4800 THX Surround EX A/V receiver, the POA-5200 can be used as the stereo front channels (left and right) amplifier, or the surround center back channels amplifier.

The POA-5200 meets Lucasfilm's stringent THX Ultra certification requirements, and provides 120 watts of power per channel, RMS into 8 ohms, and 200 watts of power per channel, RMS into 4 ohms.



## ■ THX Ultra Certified

Lucasfilm's stringent THX Ultra certification for power amplifiers includes dozens of tests and specification requirements, all to ensure accurate reproduction of motion picture soundtracks and musical performances. All aspects of power amplifier performance are thoroughly verified, to ensure inaudible noise, wide dynamic range, extended frequency response with accurate spectral response, and the ability to drive any modern loudspeaker regardless of impedance or efficiency.

## ■ Dual Monaural Configuration

Unlike conventional stereo power amplifiers, which rely upon a shared power supply for both amp channels, the POA-5200 features Denon's perfect Dual Monaural Configuration, with a separate high current power transformer and DC storage supply section for each amplifier channel. This provides the widest dynamic range, along with tremendous reserve capacity, compared to conventional stereo amplifiers.

## ■ Stabilized DC Characteristics

The use of a FET for difference input of one package type with superior direct current (DC) temperature characteristics and the ability to fine-adjust each channel individually have realized a high precision of 1 mV or less (standard value) in the output DC voltage of the POA-5200. This high-precision voltage is approximately one tenth that of conventional models and is the main reason these models are able to reproduce low-level signals with such exceptional fidelity.

## ■ A-B Speaker switching for each channel

## ■ Strictly Selected Parts for High Sound Quality

A large number of high-performance parts, such as the electrolytic capacitor customized for high sound quality, OFC wiring material, film capacitor and resistors, have all been subject to stringent listening tests during their selection process to ensure unfettered, high-grade sound reproduction.

## ■ Remote Power ON/OFF

Rear panel mounted remote power on/off terminals are provided, for connection to Denon components such as the AVR-4800, for one-button power turn-on and turn-off convenience. This allows the power amplifier to be mounted in an out-of-the-way location, thereby saving valuable shelf space for more importantly accessible source components, for example.

## Specifications

Rated output	120 W x 2 (8 ohms, 20 Hz - 20 kHz, THD 0.02 %)
	200 W x 2 (4 ohms, 1 kHz, THD 0.5%)
Total harmonic Distortion	0.008 % (-3 dB at rated output, 8 ohms, 20 Hz - 20 kHz)
Inter modulation Distortion	0.002 % (60 Hz/7 kHz : 4/1 at rated output, 8 ohms)
Frequency response	1 Hz - 100 kHz +0, -3 dB (at 1 W)
Input sensitivity	1.1 V
Input impedance	47 kohms
Output impedance	0.1 ohms (1 kHz)
Signal-to-noise ratio	110 dB (IHF, A-weighting)
Speaker	A or B 4 ohms - 16 ohms
	A + B 8 ohms - 16 ohms
Power supply	AC 120V, 60 Hz
Power consumption	4.7 A
Dimensions	434 (W) x 135 (H) x 353 (D) mm
	17.1(W) x 5.3(H) x 13.9(D)
Weight	12.3 kg, 27.1 lbs

\*Design and specifications are subject to change without notice.

\*THX is a registered trademark of Lucasfilm Ltd.

\*© Lucasfilm Ltd. & TM. All Rights Reserved. Surround EX is a jointly developed technology of THX and Dolby Labs, Inc., and is a trademark of Dolby. Used under authorization.

\*"Dolby", "Dolby Digital", "Pro Logic", and the double-D device are registered trademarks of Dolby Laboratories Licensing Corporation.

\*DTS is registered trademarks of DTS Technology.



### DENON ELECTRONICS

DIVISION OF DENON CORPORATION (U.S.A.)  
222 NEW ROAD, PARSIPPANY, NEW JERSEY 07054, U.S.A. TEL:973-396-0810  
www.del.denon.com

### DENON CANADA, INC.

17 DENISON STREET, MARKHAM ONTARIO, CANADA L3R 1B5 TEL:905-475-4085  
LABRADOR, S. A. DE C. V.

ZAMORA NO. 154, COL. CONDESA MEXICO D. F. C. P. 06140 TEL : 286-55-09/79

### NIPPON COLUMBIA CO., LTD.

14-14,AKASAKA 4-CHOME, MINATO-KU, TOKYO 107-8011, JAPAN www.denon.co.jp