

DENON

FULLY AUTOMATIC TURNTABLE SYSTEM

DP-200USB

Owner's Manual

Manuel de l'Utilisateur

SAFETY PRECAUTIONS



CAUTION
RISK OF ELECTRIC SHOCK
DO NOT OPEN



CAUTION:
TO REDUCE THE RISK OF ELECTRIC SHOCK, DO NOT REMOVE COVER (OR BACK). NO USER-SERVICEABLE PARTS INSIDE. REFER SERVICING TO QUALIFIED SERVICE PERSONNEL.

The lightning flash with arrowhead symbol, within an equilateral triangle, is intended to alert the user to the presence of uninsulated "dangerous voltage" within the product's enclosure that may be of sufficient magnitude to constitute a risk of electric shock to persons.

The exclamation point within an equilateral triangle is intended to alert the user to the presence of important operating and maintenance (servicing) instructions in the literature accompanying the appliance.

WARNING:
TO REDUCE THE RISK OF FIRE OR ELECTRIC SHOCK, DO NOT EXPOSE THIS APPLIANCE TO RAIN OR MOISTURE.

Location of Caution Labels: Bottom

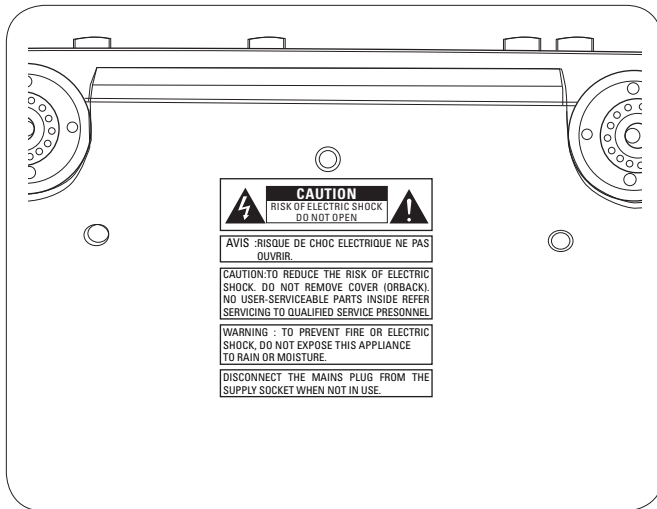

IMPOTANT SAFETY INSTRUCTIONS

1. Read these instructions.
2. Keep these instructions.
3. Heed all warnings.
4. Follow all instructions.
5. Do not use this apparatus near water.
6. Clean only with dry cloth.
7. Do not block any ventilation openings. Install in accordance with the manufacturer's instructions.
8. Do not install near any heat sources such as radiators, heat registers, stoves, or other apparatus (including amplifiers) that produce heat.
9. Do not defeat the safety purpose of the polarized or grounding-type plug. A polarized plug has two blades with one wider than the other. A grounding type plug has two blades and a third grounding prong. The wide blade or the third prong are provided for your safety. If the provided plug does not fit into your outlet, consult an electrician for replacement of the obsolete outlet.
10. Protect the power cord from being walked on or pinched particularly at plugs, convenience receptacles, and the point where they exit from the apparatus.
11. Only use attachments/accessories specified by the manufacturer.
12. Use only with the cart, stand, tripod, bracket, or table specified by the manufacturer, or sold with the apparatus. When a cart is used, use caution when moving the cart/apparatus combination to avoid injury from tip-over.
13. Unplug this apparatus during lightning storms or when unused for long periods of time.
14. Refer all servicing to qualified service personnel. Servicing is required when the apparatus has been damaged in any way, such as power-supply cord or plug is damaged, liquid has been spilled or objects have fallen into the apparatus, the apparatus has been exposed to rain or moisture, does not operate normally, or has been dropped.



FCC INFORMATION (For US customers)

1. PRODUCT

This product complies with Part 15 of the FCC Rules. Operation is subject to the following two conditions: (1) this product may not cause harmful interference, and (2) this product must accept any interference received, including interference that may cause undesired operation.

2. IMPORTANT NOTICE: DO NOT MODIFY THIS PRODUCT

This product, when installed as indicated in the instructions contained in this manual, meets FCC requirements. Modification not expressly approved by DENON may void your authority, granted by the FCC, to use the product.

3. NOTE

This product has been tested and found to comply with the limits for a Class B digital device, pursuant to Part 15 of the FCC Rules. These limits are designed to provide reasonable protection against harmful interference in a residential installation.

This product generates, uses and can radiate radio frequency energy and, if not installed and used in accordance with the instructions, may cause harmful interference to radio communications. However, there is no guarantee that interference will not occur in a particular installation. If this product does cause harmful interference to radio or television reception, which can be determined by turning the product OFF and ON, the user is encouraged to try to correct the interference by one or more of the following measures:

- Reorient or relocate the receiving antenna.
- Increase the separation between the equipment and receiver.
- Connect the product into an outlet on a circuit different from that to which the receiver is connected.
- Consult the local retailer authorized to distribute this type of product or an experienced radio/TV technician for help.

This Class B digital apparatus complies with Canadian ICES-003. Cet appareil numérique de la classe B est conforme à la norme NMB-003 du Canada.

□ NOTES ON USE / OBSERVATIONS RELATIVES A L'UTILISATION

| WARNINGS | AVERTISSEMENTS |
|--|--|
| <ul style="list-style-type: none"> • Avoid high temperatures. • Allow for sufficient heat dispersion when installed in a rack. • Handle the power cord carefully. • Hold the plug when unplugging the cord. • Keep the unit free from moisture, water, and dust. • Unplug the power cord when not using the unit for long periods of time. • Do not obstruct the ventilation holes. • Do not let foreign objects into the unit. • Do not let insecticides, benzene, and thinner come in contact with the unit. • Never disassemble or modify the unit in any way. • Ventilation should not be impeded by covering the ventilation openings with items, such as newspapers, tablecloths or curtains. • Naked flame sources such as lighted candles should not be placed on the unit. • Observe and follow local regulations regarding battery disposal. • Do not expose the unit to dripping or splashing fluids. • Do not place objects filled with liquids, such as vases, on the unit. • Do not handle the mains cord with wet hands. • When the switch is in the OFF (STANDBY) position, the equipment is not completely switched off from MAINS. • The equipment shall be installed near the power supply so that the power supply is easily accessible. | <ul style="list-style-type: none"> • Eviter des températures élevées. • Tenir compte d'une dispersion de chaleur suffisante lors de l'installation sur une étagère. • Manipuler le cordon d'alimentation avec précaution. • Tenir la prise lors du débranchement du cordon. • Protéger l'appareil contre l'humidité, l'eau et la poussière. • Débrancher le cordon d'alimentation lorsque l'appareil n'est pas utilisé pendant de longues périodes. • Ne pas obstruer les trous d'aération. • Ne pas laisser des objets étrangers dans l'appareil. • Ne pas mettre en contact des insecticides, du benzène et un diluant avec l'appareil. • Ne jamais démonter ou modifier l'appareil d'une manière ou d'une autre. • Ne pas recouvrir les orifices de ventilation avec des objets tels que des journaux, nappes ou rideaux. Cela entraverait la ventilation. • Ne jamais placer de flamme nue sur l'appareil, notamment des bougies allumées. • Veillez à respecter les lois en vigueur lorsque vous jetez les piles usagées. • L'appareil ne doit pas être exposé à l'eau ou à l'humidité. • Ne pas poser d'objet contenant du liquide, par exemple un vase, sur l'appareil. • Ne pas manipuler le cordon d'alimentation avec les mains mouillées. • Lorsque l'interrupteur est sur la position OFF (STANDBY), l'appareil n'est pas complètement déconnecté du SECTEUR (MAINS). • L'appareil sera installé près de la source d'alimentation, de sorte que cette dernière soit facilement accessible. |

CAUTION:

To completely disconnect this product from the mains, disconnect the plug from the wall socket outlet. The mains plug is used to completely interrupt the power supply to the unit and must be within easy access by the user.

PRECAUTION:

Pour déconnecter complètement ce produit du courant secteur, débranchez la prise de la prise murale. La prise secteur est utilisée pour couper complètement l'alimentation de l'appareil et l'utilisateur doit pouvoir y accéder facilement.

Contents

| | |
|---|---|
| Getting Started | |
| Accessories | 1 |
| Special Features of This Device | 1 |
| Cautions on Handlings | 1 |
| Cleaning | 1 |
| Assembly | 2 |
| Changing the Stylus | 2 |
| Removing the Replaceable Stylus | 2 |
| Mounting the Replaceable Stylus | 2 |
| Part Names and Functions | 3 |
| Connections | |
| Connections | 4 |
| Connecting the Power Cord | 4 |
| Playback | |
| Preparations | 5 |
| Preparing to Play a Record | 5 |
| Playing an Analog Record | 5 |
| Auto Start | 5 |
| Manual Start | 5 |
| Stopping a Record During Playback | 5 |
| Recording and Editing | |
| Recording an Analog Record and Editing the Recording | 6 |
| Cautions to Observe When Recording or Editing | 7 |
| Recording | 8 |
| Recording to a USB Flash Drive | 8 |
| Editing | 8 |
| Shall be Enabled by Trans Music Manager for DENON | 8 |
| Recommended System Requirements for Using Trans Music Manager | 8 |
| Installing "Trans Music Manager" | 8 |
| Editing with Trans Music Manager | 8 |
| Troubleshooting | |
| 9 | |
| Specifications | |
| 10 | |

Getting Started

Thank you for purchasing this DENON product. To ensure proper operation, please read this owner's manual carefully before using the product. After reading them, be sure to keep them for future reference.

Accessories

Check that the following parts are supplied with the product.

- ① Owner's manual 1
- ② Warranty (for North America model only) 1
- ③ Service station list 1
- ④ Platter 1
- ⑤ Rubber mat 1
- ⑥ EP adapter 1
- ⑦ Trans Music Manager (for DENON) disk (CD-ROM)..... 1

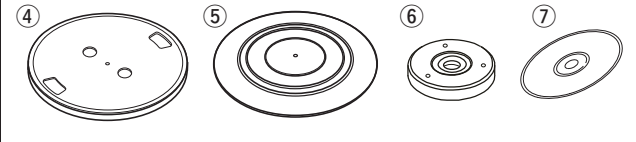

Note that the illustrations in this instructions may differ from the actual set for explanation purposes.

Special Features of This Device

- 1. Record analog records to a USB flash drive**
 - You can play back the tracks recorded on the USB flash drive on any audio device with USB playback.
 - The "Trans Music Manager" software supplied with the DP-200USB enables you to edit music files and titles on your PC.
- 2. Easy-to-operate, fully automatic player**

Simply press the **START** button to start playing an analog record. When the record is finished the tone arm automatically returns to its original position and the turntable stops.
- 3. Equalizer switch provided**

The equalizer switch enables you to connect to a variety of audio devices such as pre-main amplifiers and radio cassette players.
- 4. Lightweight, compact design**

The lightweight, compact design makes it easy to use anywhere.

Cautions on Handling

Cleaning

- Use a wiping cloth and wipe lightly to remove dirt from the cabinet and operation panel. When using chemically treated cloths, follow the precautions that have been written for them.
- Do not use benzene, thinners, or other organic solvents or insecticides on the unit since they may cause a change in quality or color.
- **Moving the unit**

To prevent short-circuits or damaged wires in the connection cables, always unplug the power supply cord and disconnect the connection cables between all other audio components when moving the unit.

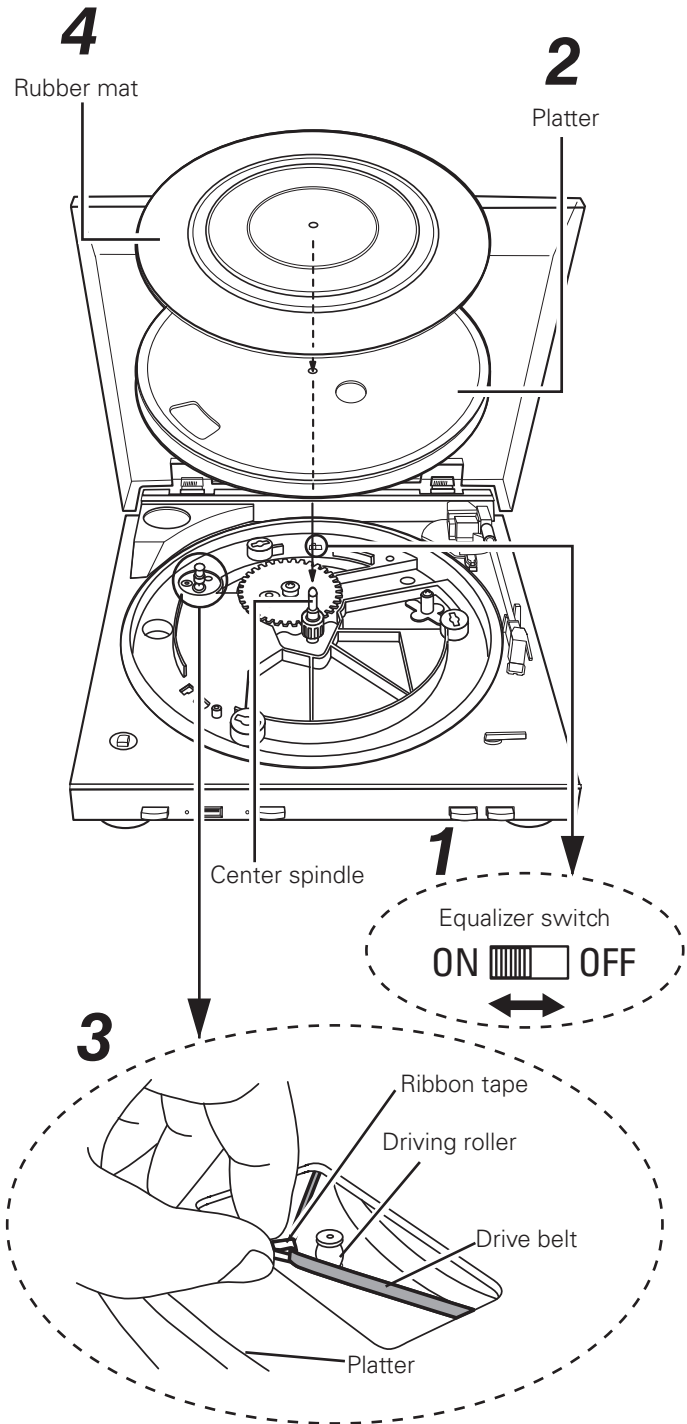

Assembly

Before assembly, remove all packaging material except for the plastic tie securing the tone arm and open the dust cover. Leave the plastic tie securing the tone arm until assembly is complete.

1 Set the equalizer switch to the appropriate position for the type of input terminal on the device connected to the DP-200USB.

ON :When connecting to an AUX input terminal or an input terminal other than "PHONO" (default setting at time of purchase).

OFF :When connecting to a PHONO input terminal.

2 Mount the platter on the center spindle.

Turn the platter so that the drive roller is visible through the opening in the platter.

3 Take hold of the ribbon tape attached to the drive belt on the underside of the platter and hook the drive belt onto the driving roller.

- Remove the ribbon tape after hooking the belt onto the roller.
- Turn the platter by hand until the drive belt is positioned at the center of the driving roller.

4 Place the rubber mat on the platter.

NOTE

If the equalizer switch is not set correctly, the sound will be extremely weak or distorted.

Changing the Stylus

The stylus supplied with the DP-200USB has a life of approximately 400 hours. Be sure to replace it in good time to avoid damaging your precious records.

Before replacing the stylus

Unplug the player at the wall socket.

Removing the Replaceable Stylus

Hold the cartridge steady with one hand, grasp the stylus with the other hand, push down in the direction of arrow ① and then gently pull the stylus off in the direction of arrow ②.

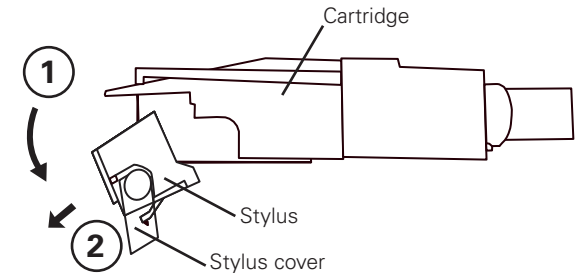

Mounting the Replaceable Stylus

Hold the cartridge steady with one hand, grasp the stylus with the other hand, point the catch on the stylus in the direction of arrow ① and insert it fully into the long opening in the cartridge, then push up in the direction of arrow ② until it clicks.

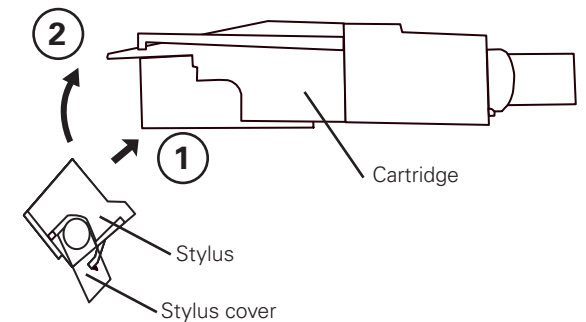

Cleaning the tip of the stylus

The tip of the stylus is extremely delicate and should be handled with great care. Use a soft brush to gently remove any dust from the tip.

Part Names and Functions

<Front>

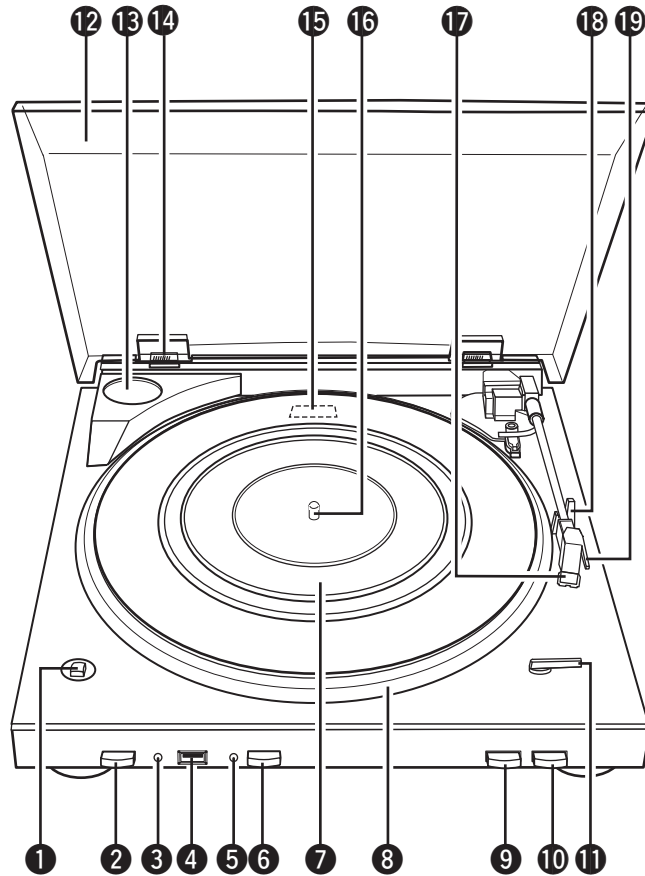

<Rear>

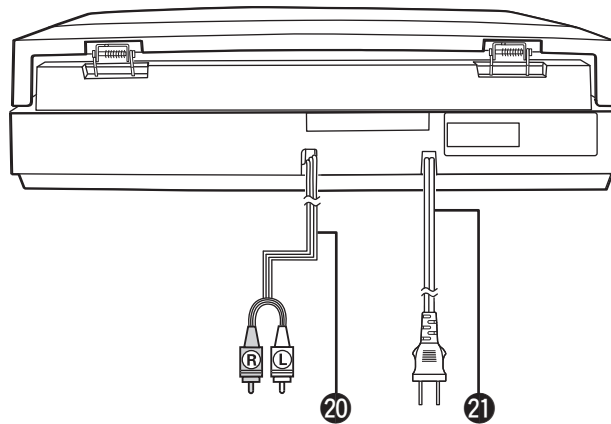

For buttons not explained here, see the page indicated in parentheses ().

- ① Speed button (SPEED 33/45)..... (5)
- ② Power operation button (POWER ON/OFF)..... (5)
- ③ USB indicator..... (8)
- ④ USB port..... (8)
- ⑤ Recording indicator..... (8)
- ⑥ REC ON/OFF button..... (8)
- ⑦ Rubber mat..... (2)
- ⑧ Platter..... (2)
- ⑨ START button..... (5)
- ⑩ STOP button..... (5)
- ⑪ Record size lever (SIZE 30/17)..... (5)
- ⑫ Dust cover..... (5)
- ⑬ EP adapter holder..... (5)
Keep your EP adapter here when not in use.
- ⑭ Dust cover hinge
- ⑮ Equalizer amplifier switch..... (2)
- ⑯ Spindle..... (2)
- ⑰ Cartridge (record stylus)..... (5)
- ⑱ Tone arm rest
- ⑲ Finger lift..... (5)
- ⑳ Audio cable (Cord length: Approx. 3.3 ft / 1 m)..... (4)
- ㉑ Power cord (Cord length: Approx. 5.9 ft / 1.8 m)..... (4)

Connections

NOTE

- Do not plug in the power cord until all connections have been completed.
- When making connections, also refer to the operating instructions of the other components.
- Be sure to connect the left and right channels properly (left with left, right with right).
- Do not bundle power cords together with connection cables. Doing so can result in humming or noise.

Connections

NOTE

Set the equalizer switch to the correct setting for the type of input terminal on the device to which the DP-200USB is being connected.

For details, refer to "Assembly" (page 2).

- ❑ When connecting to a PHONO input terminal

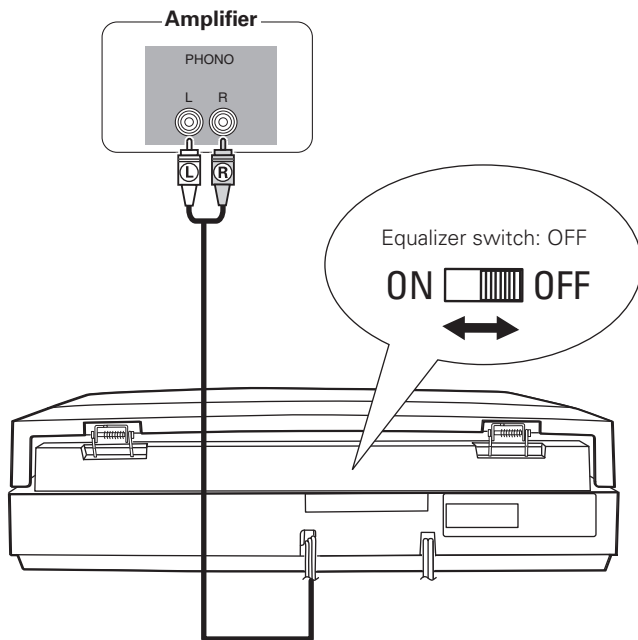

- ❑ When connecting to an AUX input terminal or an input terminal other than "PHONO"

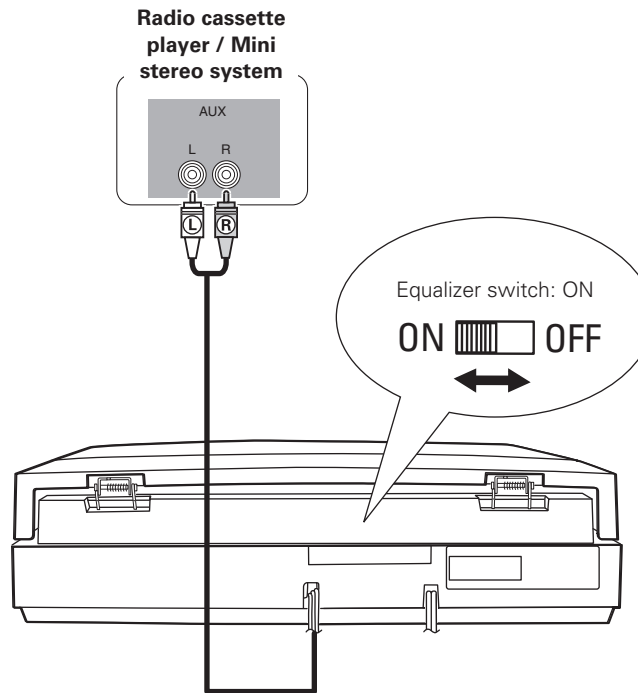

Connecting the Power Cord

Wait until all connections have been completed before connecting the power cord.

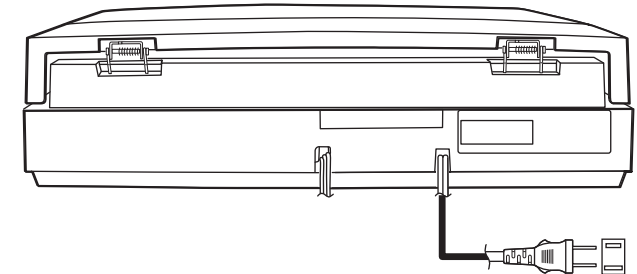

To household power outlet
(AC 120 V, 60 Hz)

NOTE

Insert the AC plugs securely. Incomplete connections could cause noise.

Playback

The DP-200USB can play analog records.

It also enables you to record your records onto a USB flash drive. For details on how to record to a USB flash drive, see "Recording and Editing" (page 6).

NOTE

The DP-200USB cannot play music recorded on a USB flash drive connected to the player.

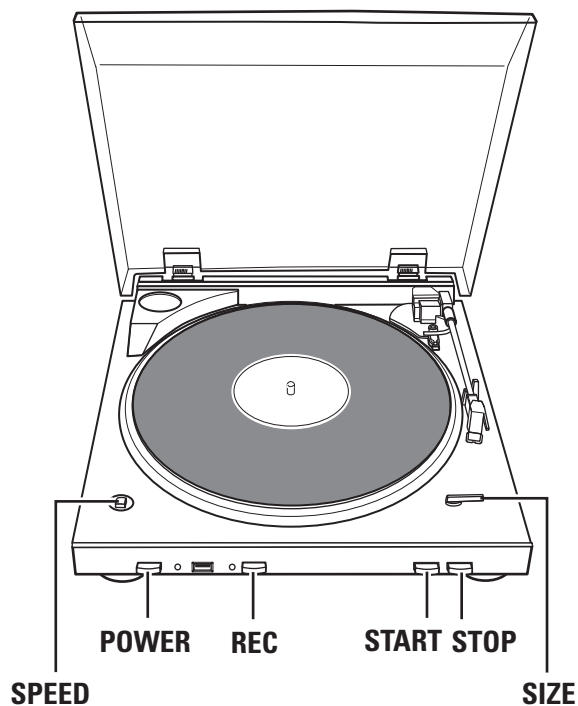

Preparations

Preparing to Play a Record

1 Press **POWER** (ON).

※ To turn power off, press **POWER** again.

2 Open the dust cover and place an analog record on the rubber mat.

※ Use the EP adapter when playing an EP record.

3 Set the record's playing speed using **SPEED**.

[Settable Items]  **33** : 33-1/3 rpm

 **45** : 45 rpm

4 Set the record's size using **SIZE**.

[Settable Items]  **30** : 0.98 ft / 30 cm

 **17** : 0.56 ft / 17 cm

5 Raise the stylus cover.

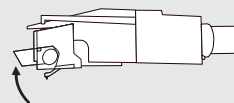

Playing an Analog Record

Auto Start

Press **START**.

The record starts playing automatically.

※ When the record is finished, the tone arm returns to its original position and the turntable stops automatically. (Auto return function)

※ To stop playing a record, turn the **POWER** "  OFF".

Manual Start

Using the finger lift, move the tone arm to the position at which you want to start playing and lower it carefully.

※ When the record is finished, the tone arm returns to its original position and the turntable stops automatically. (Auto return function)

NOTE

- Be careful not to scratch the record when moving the tone arm.
- Do not touch the tone arm or turntable or turn off the power while a record is playing. Doing so can disrupt the sound or damage the record.
- The auto start function cannot be used for 0.82 ft / 25 cm records. Records of this size should be started manually.
- The auto return function is activated when the tone arm reaches a specific point near the center of the record. In the case of a non-standard record with grooves extending beyond this point, the auto return function may be activated before the record has stopped playing.

Stopping a Record During Playback

Press **STOP**.

Playback stops and the tone arm returns to its original position.

Recording and Editing

Recording an Analog Record and Editing the Recording

Recording

You will need the following items:

DP-200USB

USB flash drive

Analog record

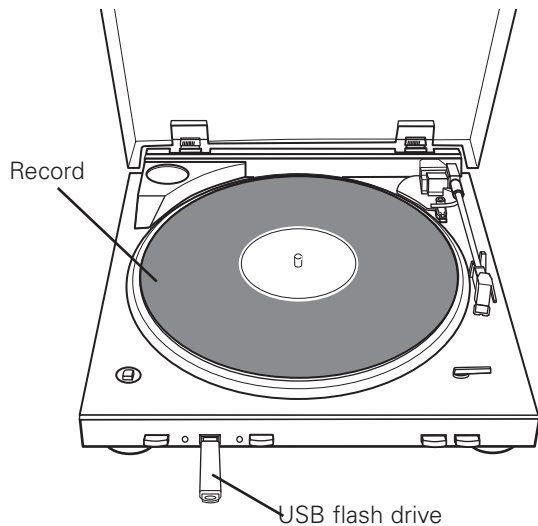

- Create a new file for each recording operation.
- Create MP3 music files.
- With a 1 GB USB flash drive, you can store up to approximately 30 LP analog records.

Editing

You will need the following items:

Trans Music Manager (CD-ROM)

A personal computer connected to the Internet

A USB flash drive containing your recording

Split files

Track 1 / Track 2 / Track 3 / Track 4



Track 1 Track 2 Track 3 Track 4

Add information such as the title of the track or album or the name of the artist

There are two ways to do this.

- ① Download from "MusicID*".
*A system for retrieving information on music tracks from Gracenote's CD database.
- ② Enter the information using your personal computer's keyboard.

Delete files

Track 1 Track 2 Track 3 Track 4

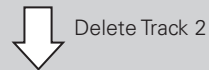

Track 1 Track 3 Track 4

Edited files can be saved on your personal computer.
(You can also save them onto a USB flash drive.)

Playback

You will need the following items:

USB flash drive containing edited (or recorded) files

Audio device with USB input

or

Personal computer

Playing on an audio device

Play on an audio device with a USB port.
(When the file has been edited on a personal computer, transfer the data to a USB flash drive.)

Playing on a personal computer

Play using the Trans Music Manager software or the audio player software installed on your personal computer.

Cautions to Observe When Recording or Editing

Cautions When Recording

- Do not remove the USB flash drive during recording. Doing so will prevent recording from taking place. Make sure that recording has finished before removing the USB flash drive.
- If the USB flash drive becomes full during recording, the recording operation will stop and the USB indicator will turn off.
- Although the tone arm will return to its original position at the end of the record, the USB flash drive does not stop recording automatically. To stop recording, press the **REC** button.
- The recording level of the USB flash drive is fixed. To adjust the volume when playing the music, use the volume controls on the audio device being used.
- If the **REC** button is turned on and then off again in less than one second, no recording will take place.
- If you record both sides of an analog record without stopping, the recording will contain a long period of silence while changing from side A to side B. To prevent this, you should stop recording after side A and start again to record side B.

Notes on Downloading Track Information

You can use the “Trans Music Manager” software included with the DP-200USB to download information on the recorded track (the title of the track or album or the name of the artist, etc.) from the Gracenote website.

- Downloading with Trans Music Manager.
 - ① Read out the opening few seconds of the recorded track’s audio waveform.
 - ② Search for a matching waveform in Gracenote®’s CD database.
 - If a match is found, the title of the track is displayed in the download list.
 - ③ Download the information.
- Track information cannot be downloaded in the following cases. In such cases, you should enter the information yourself.
 - When the recorded record has not been released as a CD.
 - When the recording contains excessive noise due to use of a worn stylus or a similar problem with recording quality.
 - When the sound quality of the CD version of the record has been enhanced by remastering, etc.

About USB Flash drive

- Only use a USB flash drive. Do not connect any other USB device.
- When a USB flash drive is connected to DP-200USB, DENON accepts no liability in the event of the USB flash drive’s data loss or damage. Be sure to back up important data.
- The USB flash drive does not operate via a USB hub.
- Operation and power supply are not guaranteed for all USB flash drives.
- The main unit’s USB port cannot be connected to a PC using a USB cable.
- Insert the USB flash drive straight and fully into the USB port. Avoid inserting at an angle as this can cause damage.
- You cannot use USB flash drives that are copyright protected.
- You cannot record on an external hard disk drive.
- You cannot record via a USB cable (including extension cable).

About Compatible OS and Personal Computers

- The following OS are compatible. Windows 2000 / Windows XP / Windows Vista (The display screen may differ in part depending on the personal computer.)
- You cannot output information to a personal computer by connecting the main unit to a personal computer.
- Operations such as system suspend, sleep (standby mode), hibernation, etc., cannot be guaranteed for all PCs.



Recording

Recording to a USB Flash Drive

1 Prepare the analog record you want to record for playing (☞ page 5 “Preparing to Play a Record”).

- ① Place the record on the rubber mat.
- ② Set the record's playing speed.
- ③ Set the record's size.
- ④ Turn the power on.

2 Insert a USB flash drive into the USB port.

- The USB indicator lights green.
- ※ If the USB flash drive has a write protection switch, make sure that it is in the unlocked position.

3 Press REC.

- The Recording indicator lights red (preparing to record).
 - The Recording indicator blinks red and recording starts.
- ※ The time from pressing **REC** (the recording indicator lights red) to when recording starts (the red light blinks) varies with the USB flash drive capacity and type. Check the time to start of recording beforehand.

4 Press START.

- ※ If you are starting the record manually, use the finger lift to move the tone arm to the position at which you want to start playing and lower it carefully.

NOTE

- When removing the USB flash drive, gently hold the DP-200USB with your other hand to keep it steady.
- Do not remove the USB flash drive during recording.

☐ To Stop Recording

- Press **REC**.
- The Recording indicator turns off.



The included “Trans Music Manager” can be used to delete silent sections recorded before and after a track.

- ① Create a single track from the section to be deleted. “Manual MP3 Splitter” (☞ Brief manual (CD-ROM) page 11)
- ② Delete the track created in step ①. “Deleting tracks” (☞ Brief manual (CD-ROM) page 28)

Editing

Shall be Enabled by Trans Music Manager for DENON

You can use Trans Music Manager to perform the following functions.

- ☐ File Splitter
 - Auto MP3 Splitter
 - Manual MP3 Splitter
- ☐ MusicID (Addition of track information)
 - Track name, Artist name, Album name, etc.
 - Access Gracenote® on the internet
 - Character Entry
- ☐ File deletion

Trans Music Manager is a trademark and registered trademark of Trans Technology, Inc.
Information concerning music identification technology is offered by Gracenote, Inc.
Gracenote® and CDDB® are registered trademarks of Gracenote.

About Gracenote MusicIDSM Music Recognition Service

“Gracenote MusicIDSM music recognition service” is a service offered by Gracenote® that is commonly known as CDDB®. The service lets you automatically obtain CD titles, artist names, track names, etc., in text format by connecting to the Gracenote® server on the Internet.

Recommended System Requirements for Using Trans Music Manager

- A personal computer running Windows 2000/Windows XP/Windows Vista
- An HDD with a minimum of 30 MB free space
- A USB 2.0 port

Installing “Trans Music Manager”

1 Insert the included CD-ROM (Trans Music Manager) in your PC.

The top menu screen is displayed.

- ※ If the top menu screen is not displayed, open the CD-ROM drive under “My Computer” and start “TMMLaunch.exe”.

2 Click on “Trans Music Manager installation”.

The InstallShield Wizard screen is displayed.

3 Operate while reading the screen explanations.

Installation starts.

4 Click on “Finish”.

Installation finishes.

Editing with Trans Music Manager

For details of the editing operation, refer to the “Simple User's Guide” which is included on the CD-ROM supplied with the DP-200USB.

Troubleshooting



If a problem should arise, first check the following:

1. Are the connections correct?
2. Is the set being operated as described in the owner's manual?

If this unit does not operate properly, check the items listed in the table below. Should the problem persist, there may be a malfunction.

In this case, disconnect the power immediately and contact your store of purchase.

[Playing records]

| Status | Check | Page |
|--|---|--------|
| Power does not turn on. | <ul style="list-style-type: none"> • Is the DP-200USB's power cord plugged into the wall socket properly? • Is the power button "  ON"? | 4 5 |
| The turntable does not turn. | <ul style="list-style-type: none"> • Is the DP-200USB's power cord plugged into the wall socket properly? • Is the drive belt attached properly to both the platter and the driving roller? If the drive belt has become detached, reattach it to the platter first and then hook it onto the driving roller. For details, refer to "Assembly" ( page 2). | 4 |
| | | 2 |
| No sound is produced | <ul style="list-style-type: none"> • Is the audio cable connected properly? • Has the amplifier been set correctly for use with the DP-200USB audio cable? • Is the replaceable stylus mounted in the cartridge properly? | 4 |
| | | 4 |
| | | 2 |
| The sound is scratchy, the stylus skips or the sound is distorted. | <ul style="list-style-type: none"> • Is the stylus or the record dirty? • Is the stylus worn or the record scratched? | 2 |
| | | 2 |
| The tone arm does not move even when the START button is pressed. | <ul style="list-style-type: none"> • Is the DP-200USB's power cord plugged into the wall socket properly? • Is the power button "  ON"? • Is the tone arm secured to the armrest? | 4 |
| | | 5 |
| | | 3 |

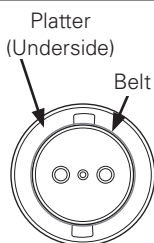

[USB flash drive]

| Status | Check | Page |
|---|---|------------------|
| The USB flash drive is not recognized. | <ul style="list-style-type: none"> • Is the USB flash drive inserted fully into the port? • Is the USB flash drive full? | 8 8 |
| Nothing is recorded on the USB flash drive. | <ul style="list-style-type: none"> • Is the USB flash drive inserted fully into the port? • Is the USB flash drive full? • The USB flash drive is incompatible with the personal computer. • Was the USB flash drive removed during recording (without stopping recording)? | 8 8 8 8 |
| The USB flash drive cannot be formatted. | <ul style="list-style-type: none"> • You cannot format a USB flash drive with the DP-200USB. To format the flash drive, use your personal computer. | – |

[Editing]

| Status | Check | Page |
|--|---|--------|
| Files cannot be edited | <ul style="list-style-type: none"> • Have you installed the CD-ROM supplied with the DP-200USB on your personal computer? • Has the file been recorded on the USB flash drive properly? (Has the file of the track been created in the folder properly?) • Is your personal computer connected to the Internet? (Track information cannot be downloaded if you are not connected to the internet.) | 8 |
| | | – |
| | | 6 |
| Files cannot be batch split | <ul style="list-style-type: none"> • Change the batch split setting menu and try the batch splitting operation again. • Batch splitting of files is not possible under certain recording conditions. In such cases, the files can be split manually. | 8 |
| | | 8 |
| Track information does not download | <ul style="list-style-type: none"> • Is your personal computer connected to the Internet? • Track information cannot be downloaded in the following cases. <ul style="list-style-type: none"> · When the record concerned has not been released as a CD (it is not in the CD database). · When the sound has not been recorded properly due to a worn stylus. · When the sound quality of the CD version of the record concerned has been enhanced by remastering, etc. | 6 7 |
| | | 8 |
| Track information is acquired only for some of the files of a recorded album | <ul style="list-style-type: none"> • Select "Identify tracks as albums" when searching MusicID. • Even if the search finds only one matching track in the album, you can obtain the track information from the album list manually. | 8 8 |

Specifications

Turntable

| | |
|-----------------------------------|--|
| Drive system: | Belt drive |
| Motor: | DC servo motor |
| Speed: | 33-1/3, 45 rpm |
| Wow & flutter: | 0.15 % WRMS |
| Tone arm: | Dynamic balanced type |
| Effective arm length: | 195 mm |
| Cartridge: | MM type |
| Output voltage: | Equalizer OFF: 2.5 mV Equalizer ON : 150 mV |
| Optimal stylus pressure: | 3.5 g |
| Replaceable stylus number: | DSN-84 |
| USB port : | USB recording, compatible with USB A and USB 1.1 |

General

| | |
|-------------------------------------|---|
| Power supply: | AC 120 V, 60 Hz |
| Power consumption: | 12 W |
| Maximum external dimensions: | With dust cover closed: 360 (W) × 98 (H) × 358 (D) mm (14-11/64" × 3-55/64" × 14-3/32") With dust cover open: 360 (W) × 415 (H) × 363 (D) mm (14-11/64" × 16-11/32" × 14-19/64") |
| Weight: | 3.2 kg (7 lbs 0.9 oz) |

* For purposes of improvement, specifications and design are subject to change without notice.

DENON

www.denon.com

D&M Holdings Inc.
Printed in China 5411 10166 40AD