

# 请先 读我

快速入门指南

DENON®

DCD-A110









110  
Anniversary

# 欢迎



感谢您选购Denon CD播放机。  
本指南为您设置CD播放机提供逐步说明。

# 开始之前

## 包装盒中物品清单

|        |   |               |   |
|--------|---|---------------|---|
| 快速入门指南 |  | 电源线           |  |
| 安全说明   |  | 遥控器 (RC-1237) |  |
| 保修卡    |  | R03/AAA电池     |  |
| CD播放机  |  | 音频电缆          |  |

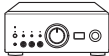
## 基本连接所需物品

|   |   |   |
|---|---|---|
|  |  |  |
| 放大器   | 扬声器   | 扬声器电缆   |



请注意，本手册中的插图为示意图，可能与实物有差异。

# 设置步骤

设置过程包括五个步骤。

**1** 正在遥控器单元中安装电池

**2** 将DCD-A110连接到放大器

**3** 将电源线插入电源插座

**4** 开启DCD-A110的电源

**5** 开始播放CD或超级音频CD

**1**

正在遥控器单元中安装电池

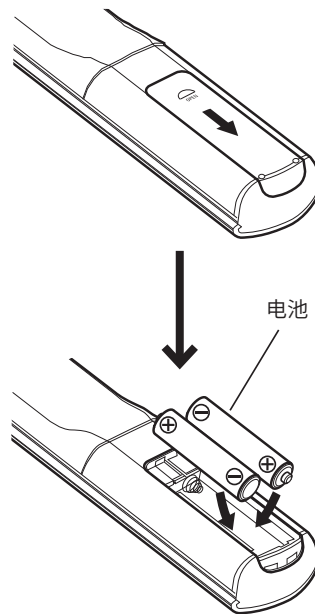

## 2

将DCD-A110连接到放大器

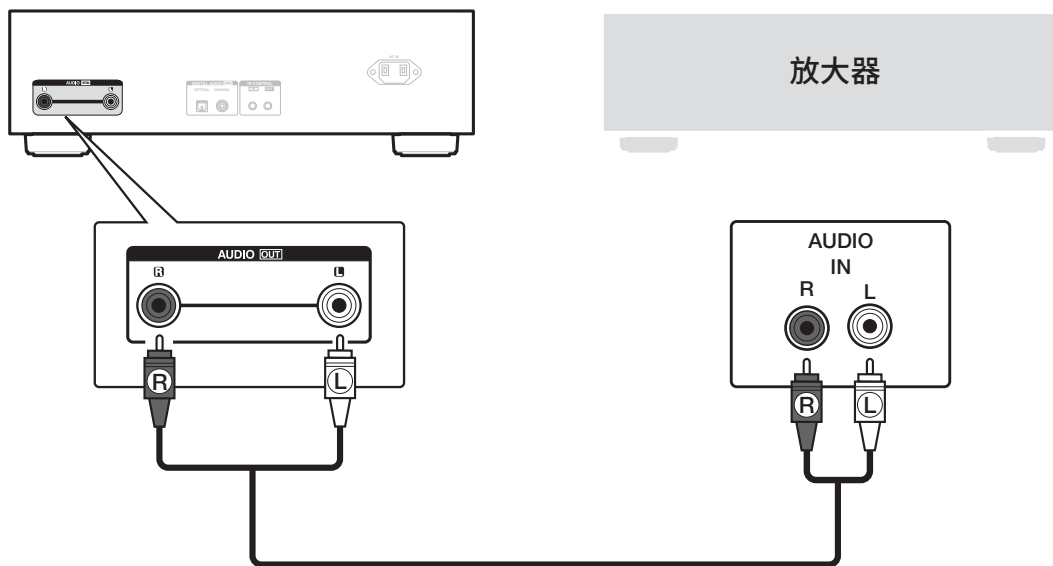

# 3

## 将电源线插入电源插座

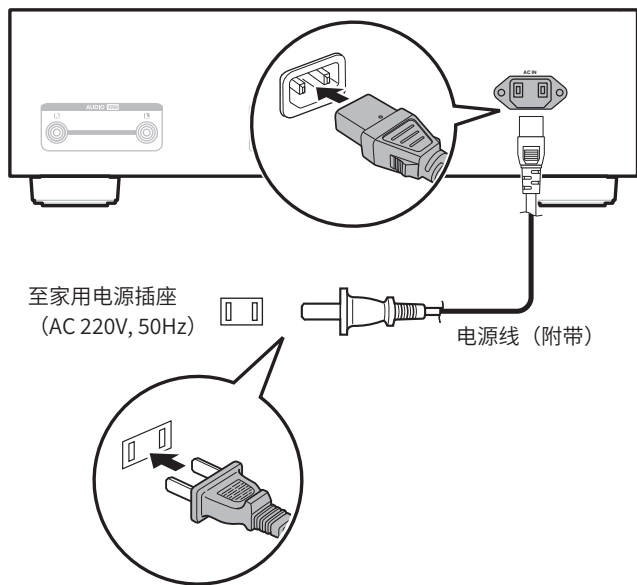

# 4

## 开启DCD-A110的电源

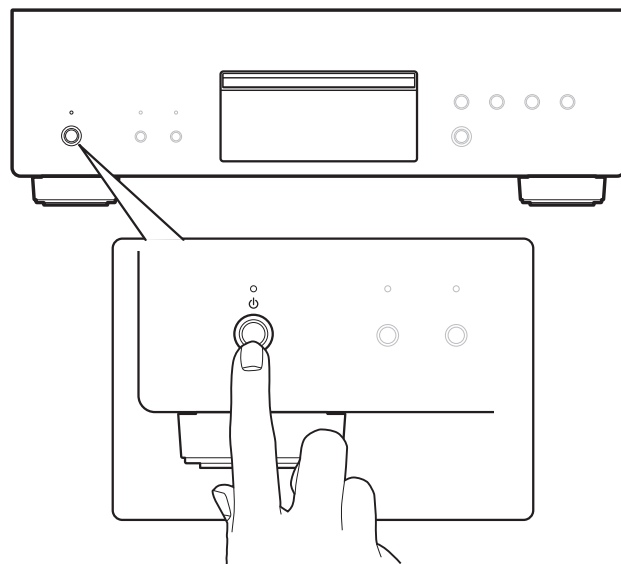

# 5

## 开始播放CD或超级音频CD

1 按 ▲ 键打开光碟托盘。

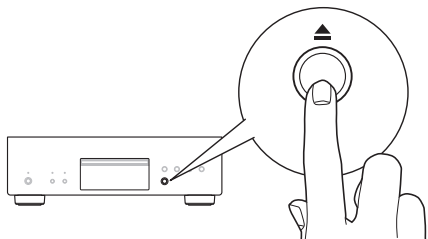

2 将CD插入光碟托盘中。

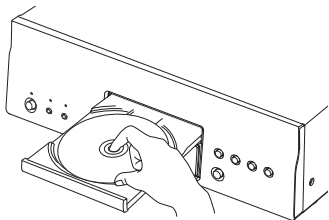

3 按 ▶/⏸ 键。  
开始播放。

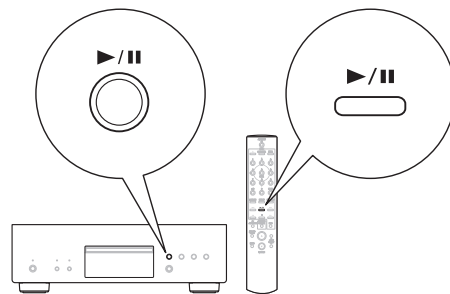

# 操作说明书

- 有关其他功能信息和操作步骤详情，请参阅在线手册。

[manuals.denon.com/DCDA110/AP/ZH/](http://manuals.denon.com/DCDA110/AP/ZH/)



在线手册

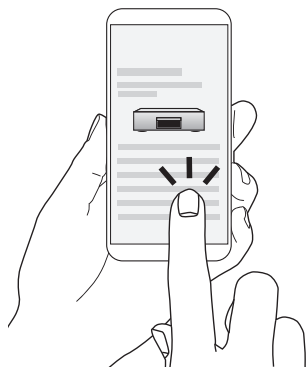

- 有关更多信息，请访问 [www.denon.com.cn](http://www.denon.com.cn)

**DENON®**  
[www.denon.com](http://www.denon.com)

Printed in Japan 5411 11860 00AD  
© 2020 Sound United. All Rights Reserved.