

DENON[®]

D-T1

CD RECEIVER SYSTEM

Owner's Manual

[Front panel](#)[Rear panel](#)[Remote control
unit](#)[Index](#)

Accessories	5
Inserting the batteries	6
Operating range of the remote control unit	6
Features	7
Part names and functions	8
Front panel	8
Rear panel	11
Remote control unit	13

Connections

Connecting speakers	17
Connecting the speaker cables	17
Connecting speakers	18
Connecting an analog device	19
Connecting a digital device	19
Connecting an FM/AM antenna	20
Connecting the power cord	22



Playback

Basic operation	24
Turning the power on	24
Switching the power to standby	24
Selecting the input source	25
Adjusting the volume	25
Turning off the sound temporarily (Muting)	25
Playing CDs	26
Playing CDs	26
Playing tracks in a specific order (Program playback)	27
Playing DATA CDs	28
Playing files	29
Listening to FM/AM broadcasts	30
Listening to FM/AM broadcasts	30
Presetting FM/AM stations	31
Listening to preset stations	31
Setting the preset channels and changing the received frequency on the main unit	32
About RDS	32

Listening to music on a Bluetooth device	33
Listening to music on a Bluetooth device	34
Pairing with other Bluetooth devices	35
Disconnecting from Bluetooth	36
Setting the Bluetooth standby mode	36
Reconnecting to this unit from a Bluetooth device	37
Playing digital input	38
Playing analog input	39
Convenience functions	40
Adjusting the tone	41
Switching the display's brightness	42



Settings

Setting the clock, timer playback and sleep timer	44
Setting the current time	44
Displaying the clock constantly	45
Setting the timer playback	46
Setting the timer playback mode	47
Sleep timer function	47
Setting the Auto Standby mode	48
Turning Auto Standby mode off	48
Turning Auto Standby mode on	48

Tips

Tips	50
Troubleshooting	51
Resetting factory settings	59

Appendix

Playing back DATA CDs	60
DIGITAL IN	61
Playing back Bluetooth devices	61
About Discs	62
Last function memory	64
Explanation of terms	65
Trademark information	66
Specifications	67
Index	71







Thank you for purchasing this Denon product.

To ensure proper operation, please read this owner's manual carefully before using the product.

After reading this manual, be sure to keep it for future reference.

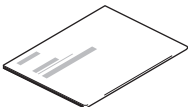
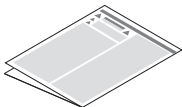
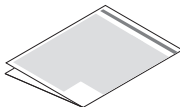
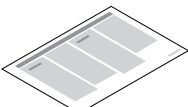
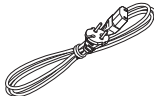
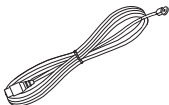
Accessories

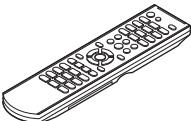
Check that the following parts are supplied with the product.

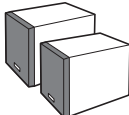
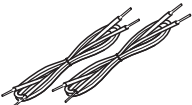
 Quick Start Guide	 Safety Instructions	 Cautions on Using Batteries	 Notes on radio	 Power cord
 FM indoor antenna	 AM loop antenna	 Remote control unit (RC-1229)	 LR03/AAA batteries	 Speakers
 Speaker cables				



Inserting the batteries

- 1 Remove the rear lid in the direction of the arrow and remove it.

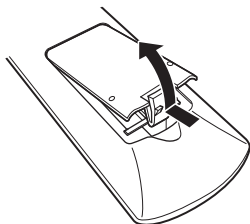

- 2 Insert two batteries correctly into the battery compartment as indicated.

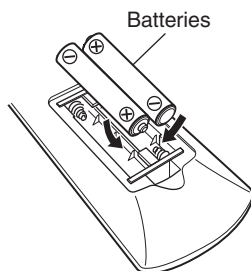

- 3 Put the rear cover back on.

NOTE

- To prevent damage or leakage of battery fluid:
 - Do not use a new battery together with an old one.
 - Do not use two different types of batteries.
- Remove the batteries from the remote control unit if it will not be in use for long periods.
- If the battery fluid should leak, carefully wipe the fluid off the inside of the battery compartment and insert new batteries.

Operating range of the remote control unit

Point the remote control unit at the remote sensor when operating it.

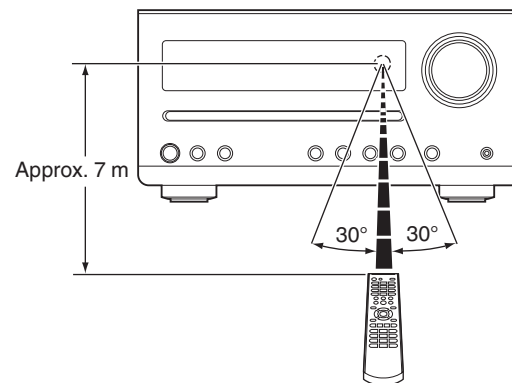

Features

- **High quality amplifier stressing sound quality**
Equipped with a 15 W + 15 W (6 Ω/ohms) high-quality amplifier circuits.
- **Simple & Straight circuit design for sound purity and free of coloration**
Gives you high sound quality based on the simple and straight concept. Circuitry is uncomplicated, signal paths are short, and all adverse influences on sound quality have been minimized.
- **Auto standby mode**
This unit also provides the Auto standby mode, where it goes into the standby state when there is no operation for 15 minutes.
- **Low standby power consumption**
Designed with the environment in mind, the unit consumes just 0.3 W while in standby mode.
- **Remote control unit**
This unit is shipped with a remote control unit. The button layout is designed so that the buttons are easy to press for greater operability.
- **Equipped with optical digital audio input, enabling connection with TV or digital devices**
You can connect audio from a TV or a media player digitally to enjoy impressive, high-quality sound.
- **Wireless connection with Bluetooth enabled devices**
( p. 33)
You can connect Bluetooth enabled devices such as smartphones and tablets with this unit to listen to music while browsing email and Web sites in the Internet away from this unit. In addition, this unit supports high quality audio codecs, AAC, to enjoy music and games with a powerful sound.
- **Compact speakers with high sound quality**
The speakers have a high-resonance soft dome tweeter and responsive 12cm-wide paper cone wafers. Along with the bass reflex duct on the back, these balance a substantial volume with sharp sound for high sound quality.



Part names and functions

Front panel

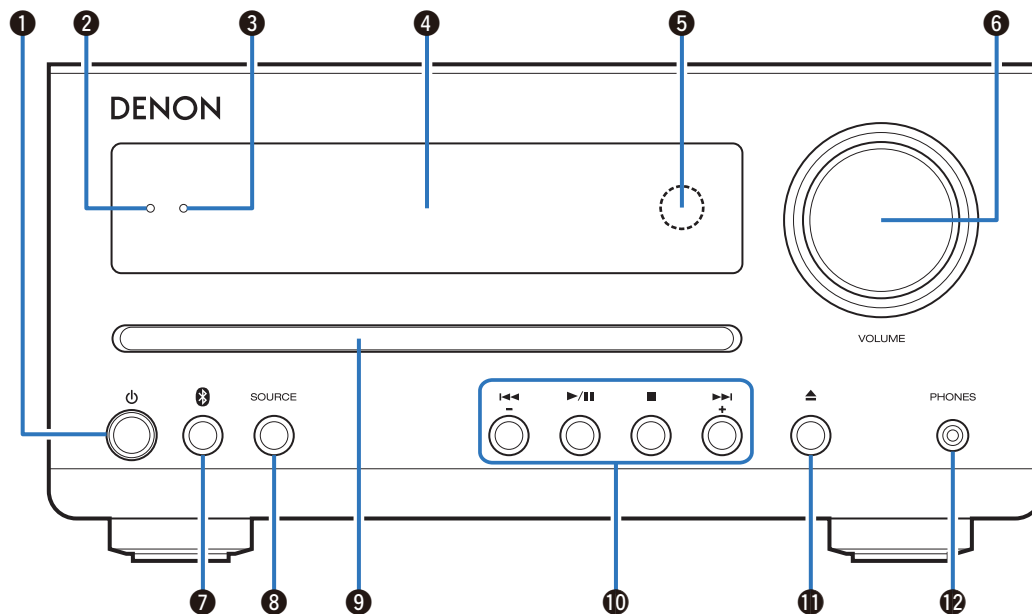

For details, see the next page.

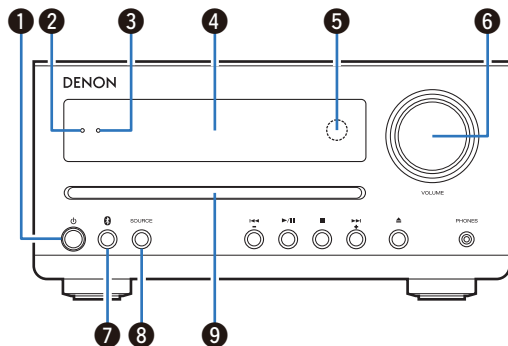

1 Power operation button (⏻)

Turns power to this unit on and off (standby).
([☞ p. 24](#))



- When "CLK MODE" is turned on, this button switches between normal mode and Clock mode. ([☞ p. 45](#))

2 Power indicator

This is lit as follows according to the power status:

- Power on : Green
- Normal standby : Off
- Alarm standby : Orange ([☞ p. 46](#))

3 Bluetooth indicator

This lamp is lit or blinks depending on the Bluetooth connection status.

- "Listening to music on a Bluetooth device" ([☞ p. 34](#))
- "Setting the Bluetooth standby mode" ([☞ p. 36](#))

4 Display

This displays various pieces of information.

5 Remote control sensor

This receives signals from the remote control unit. ([☞ p. 6](#))

6 VOLUME knob

Adjusts the volume. ([☞ p. 25](#))

7 Bluetooth button (📶)

This switches the input to Bluetooth. This is also pressed during the pairing operation. ([☞ p. 33](#))

8 SOURCE button

These select the input source. ([☞ p. 25](#))

9 Disc slot

Used to insert a disc. ([☞ p. 26](#))



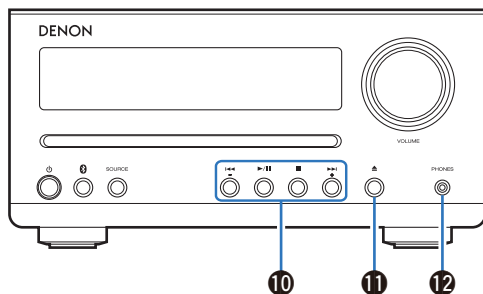

10 System buttons

These perform playback related operations.

Preset/Tuning buttons (-, +)

These select FM broadcast and AM broadcast. (☞ p. 30)

11 Disc eject button (▲)

Ejects the disc.

12 Headphones jack (PHONES)

Used to connect headphones.

When the headphones are plugged into this jack, audio will no longer be output from the connected speakers.

NOTE

- To prevent hearing loss, do not raise the volume level excessively when using headphones.



Rear panel

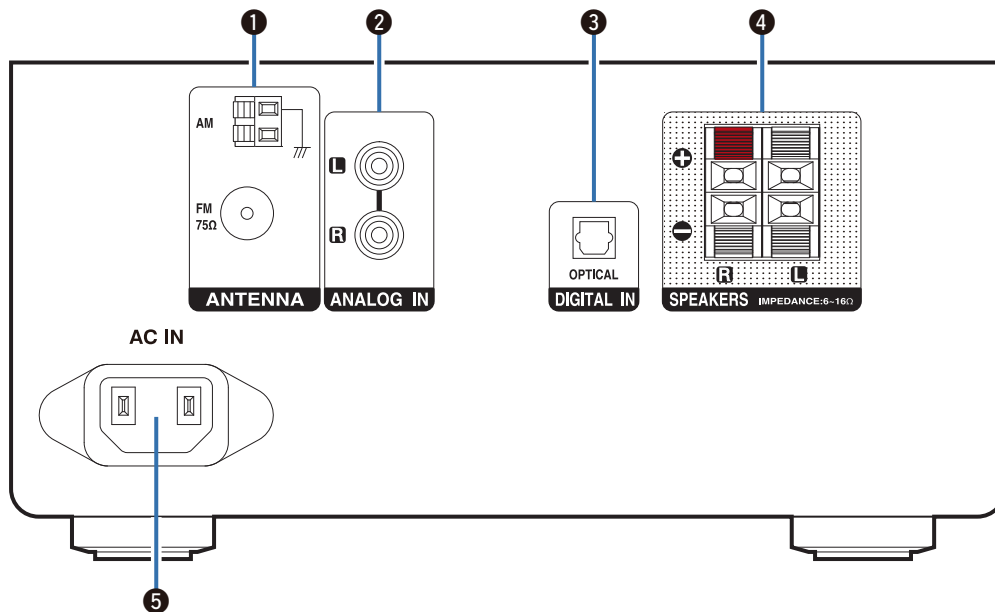

For details, see the next page.



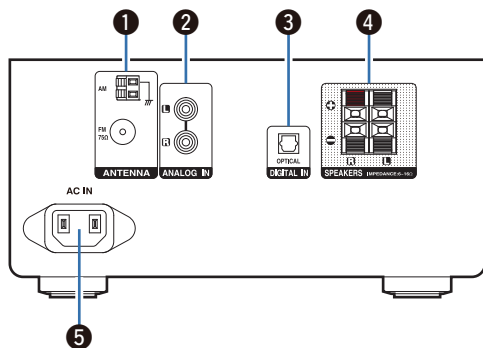

1 Antenna terminals (ANTENNA)

Used to connect FM antennas and AM loop antennas. (☞ p. 20)

2 ANALOG IN connectors

Connecting to a device with analog audio output connectors.

(☞ p. 19)

3 DIGITAL IN connector

Connecting to a device with digital audio output connectors.

(☞ p. 19)

4 Speaker terminals (SPEAKERS)

Used to connect speakers. (☞ p. 17)

5 AC inlet (AC IN)

Used to connect the power cord. (☞ p. 22)



Remote control unit

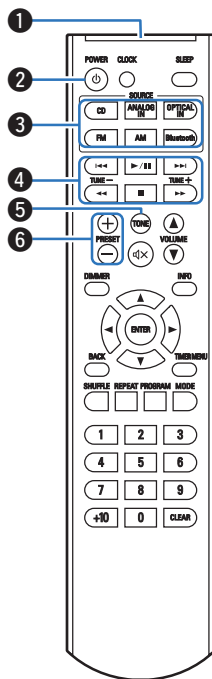

1 Remote control signal transmitter

This transmits signals from the remote control unit. (☞ p. 6)

2 POWER button (⏻)

This turns the power on/standby. (☞ p. 24)

3 Input source select buttons

These select the input source. (☞ p. 25)

4 System buttons

These perform playback related operations.

Tuning buttons (TUNE +, -)

These select FM broadcast and AM broadcast. (☞ p. 30)

5 TONE button

Adjusting the tone. (☞ p. 41)

6 Preset buttons (PRESET +, -)

These select preset broadcast stations. (☞ p. 31)



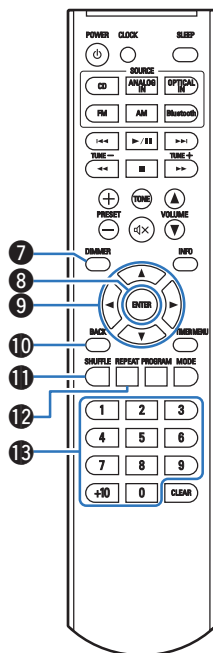

- 7 DIMMER button**
Adjust the display brightness of this unit. (☞ p. 42)
- 8 ENTER button**
This determines the selection.
- 9 Cursor buttons (Δ▽◀▶)**
These select items.
- 10 BACK button**
Returns to the previous item.
- 11 SHUFFLE button**
Shuffle the tracks.
- 12 REPEAT button**
Switches to the repeat playback.
- 13 Number buttons (0 – 9, +10)**
These enter numbers into the unit.



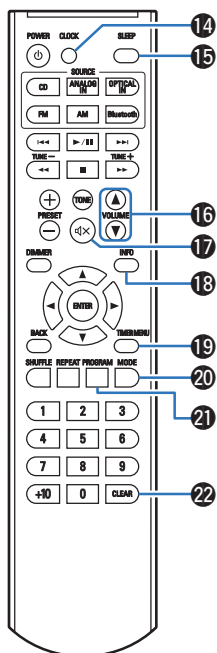

14 CLOCK button

The current time appear on the unit. (☞ p. 44)

15 SLEEP button

This sets the sleep timer. (☞ p. 47)

16 VOLUME buttons (▲▼)

Adjusts the volume. (☞ p. 25)

17 Mute button (🔇)

This mutes the output audio. (☞ p. 25)

18 Information button (INFO)

This switches the track information shown in the display during playback.

19 TIMER MENU button

The timer setting menu is displayed on the display of the unit. (☞ p. 44)

20 MODE button

- This switches the operation mode for the FM tuning. (☞ p. 30)
- This switches the playback range on a data CD. (☞ p. 29)
- Use this to connect, disconnect and pair with Bluetooth devices. (☞ p. 33)

21 PROGRAM button

This sets program playback. (☞ p. 27)

22 CLEAR button

This cancels the settings.



■ Contents

Connecting speakers	17
Connecting an analog device	19
Connecting a digital device	19
Connecting an FM/AM antenna	20
Connecting the power cord	22

NOTE

- Do not plug in the power cord until all connections have been completed.
- Do not bundle power cords with connection cables. Doing so can result in noise.

■ Cables used for connections

Provide necessary cables according to the devices you want to connect.

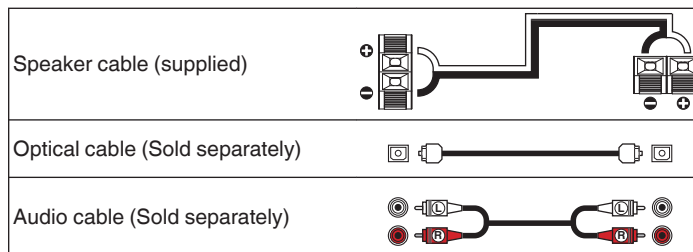

Connecting speakers

Here we connect the speakers in the room to this unit.

This section explains how to connect them using typical examples.

NOTE

- Disconnect this unit's power plug from the power outlet before connecting the speakers.
- Connect so that the speaker cable core wires do not protrude from the speaker terminal. The protection circuit may be activated if the core wires touch the rear panel or if the + and - sides touch each other. "Protection circuit" (☞ p. 66)
- Never touch the speaker terminals while the power cord is connected. Doing so could result in electric shock.
- Use speakers with an impedance of 6 – 16 Ω/ohms.

Connecting the speaker cables

Carefully check the left (L) and right (R) channels and + and – polarities on the speakers being connected to this unit, and be sure to connect the channels and polarities correctly.

- 1 Peel off about 10 mm of sheathing from the tip of the speaker cable, then twist the core wire tightly.**



- 2 Push the lever of the speaker terminal and insert the speaker cable into the cable insertion slot.**

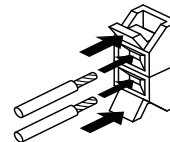

- 3 Release your finger from the speaker terminal lever to fix the speaker cable.**

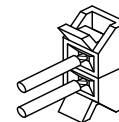

Connecting speakers

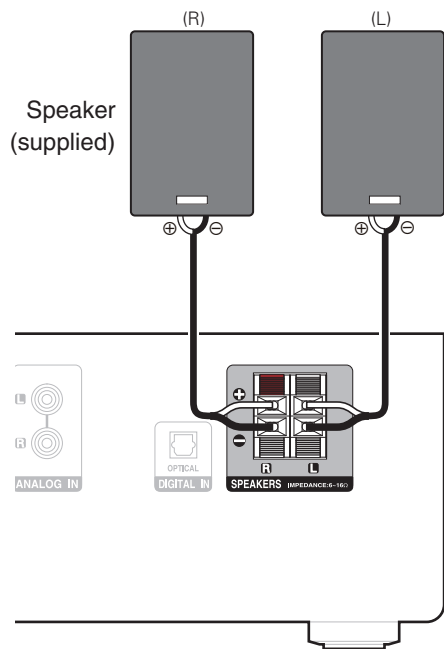

Connecting an analog device

You can connect this unit to various devices with analog audio output.

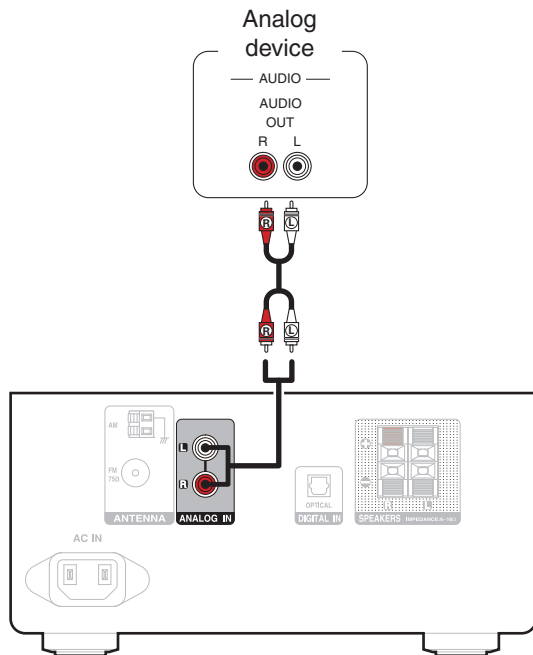

Connecting a digital device

You can connect this unit to devices with digital audio output (TV, digital gear, etc.).

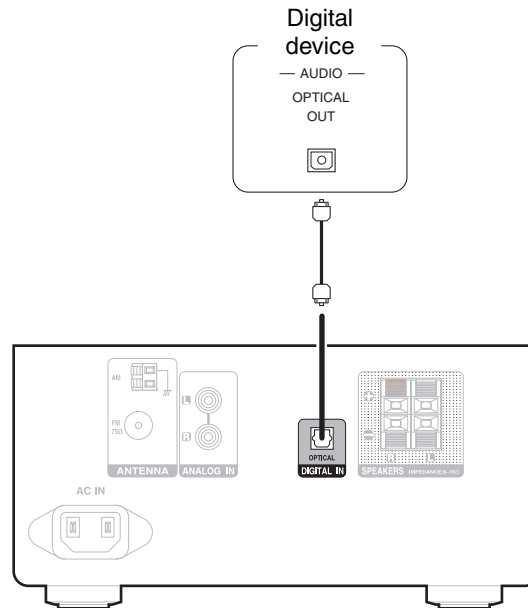

■ Specifications of supported audio formats

See "DIGITAL IN" (👉 p. 61).



Connecting an FM/AM antenna

Connect the antenna, tune in to a broadcast and then move the antenna to the location where there is least noise. Then use tape, etc. to fix the antenna in this location. “Listening to FM/AM broadcasts” (🔗 p. 30)

AM loop antenna
(supplied)

FM indoor antenna
(supplied)

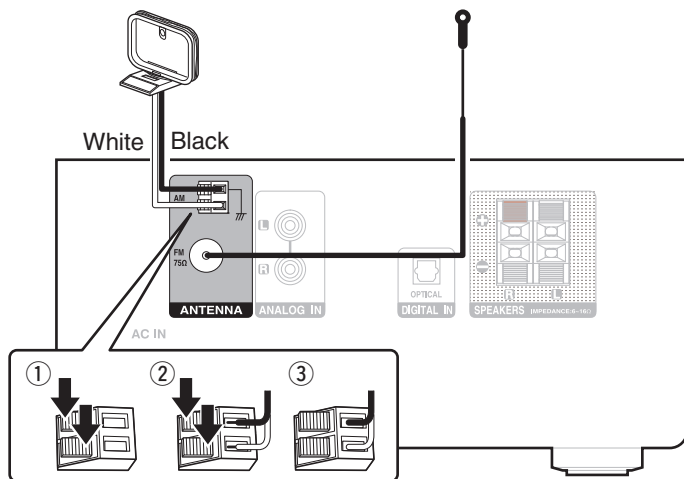

- If you are unable to receive a good broadcast signal, we recommend installing an outdoor antenna. For details, inquire at the retail store where you purchased the unit.

NOTE

- Make sure the AM loop antenna lead terminals do not touch metal parts of the panel.



■ Using the AM loop antenna

Suspending on a wall

Suspend directly on a wall without assembling.

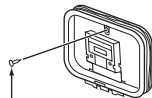

Nail, tack, etc.

Standing alone

Use the procedure shown above to assemble.

When assembling, refer to “AM loop antenna assembly”.

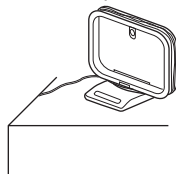

■ AM loop antenna assembly

- 1 Put the stand section through the bottom of the loop antenna from the rear and bend it forward.
- 2 Insert the projecting part into the square hole in the stand.

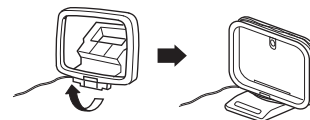
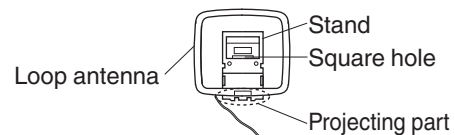

Connecting the power cord

After completing all the connections, insert the power plug into the power outlet.

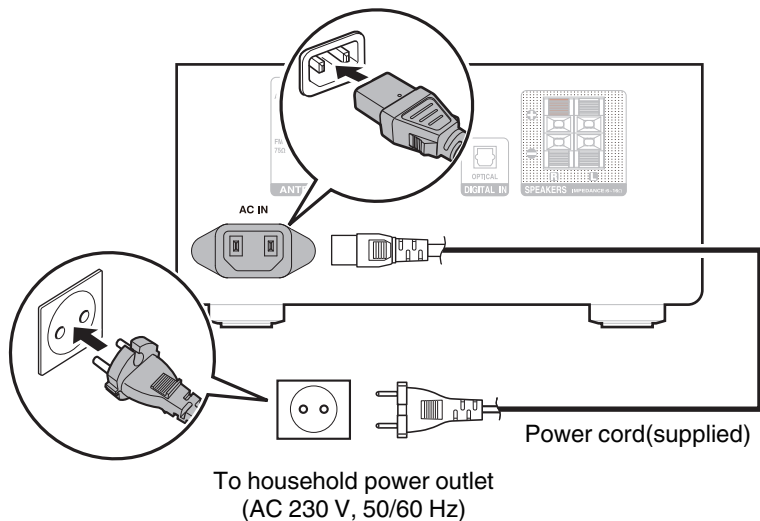

■ Contents

Basic operation

Turning the power on	24
Switching the power to standby	24
Selecting the input source	25
Adjusting the volume	25
Turning off the sound temporarily (Muting)	25

Playback a device

Playing CDs	26
Playing DATA CDs	28
Listening to FM/AM broadcasts	30
Listening to music on a Bluetooth device	33
Playing digital input	38
Playing analog input	39

Other functions

Convenience functions	40
-----------------------	----



Basic operation

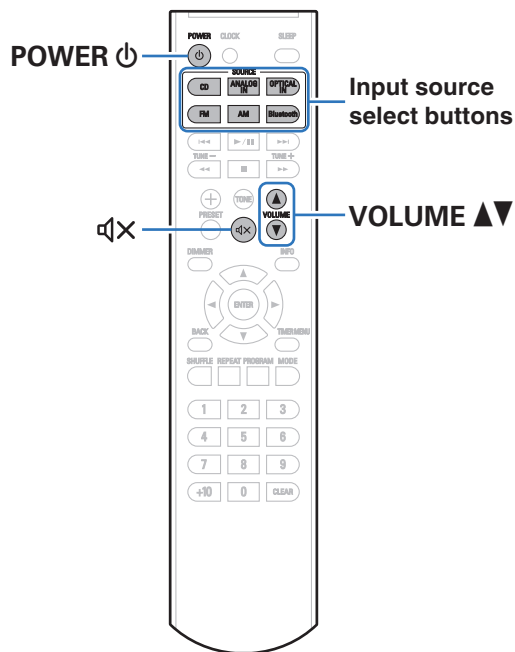

Turning the power on

- 1 Press **POWER** to turn on power to the unit.
The power indicator lights green.



- You can also press on the main unit to turn on power from standby mode.

Switching the power to standby

- 1 Press **POWER** .
- The unit switches to standby mode.



- You can also switch the power to standby by pressing on the main unit.

NOTE

- Power continues to be supplied to some of the circuitry even when the power is in the standby mode. When leaving home for long periods of time or when going on vacation, unplug the power cord from the power outlet.



Selecting the input source

1 Press the input source select button to be played back.

The selected input source appears on the display.



- You can also select the input source by pressing SOURCE on the main unit.

Adjusting the volume

1 Use VOLUME ▲▼ to adjust the volume.

The volume level appears on the display.



- You can also adjust the volume by turning VOLUME on the main unit.

Turning off the sound temporarily (Muting)

1 Press **MUTE**.

"MUTE" is displayed on the display.



- To cancel mute, either adjust the sound volume or press **MUTE** again.



Playing CDs

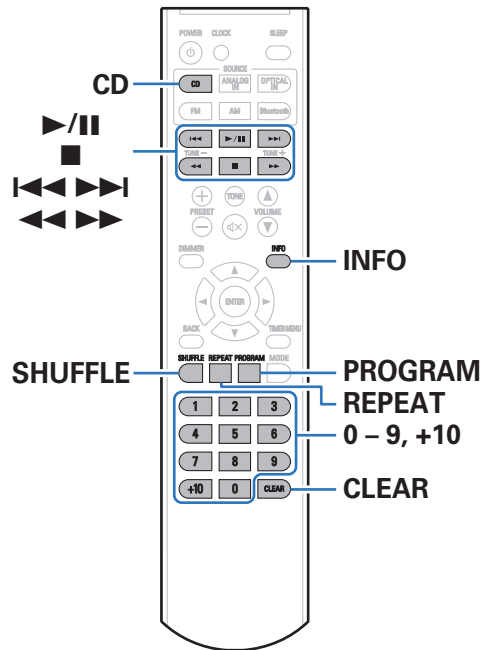

Playing CDs

- 1** Press CD to switch the input source to “CD”.
- 2** Insert a disc. ([🔗 p. 62](#))
- 3** Press ▶/||.
Playback starts.

NOTE

- 8 cm discs cannot be used on this unit. Do not insert 8 cm discs into the disc slot.
- Do not put anything other than a CD to disc slot. Doing so could result in damage.



Operation buttons	Function
	Playback / Pause
	Stop
	Skip to previous track / Skip to next track
	(Press and hold) Fast-reverse / Fast-forward
0 - 9, +10	Select the track
SHUFFLE	Shuffle playback
REPEAT	Repeat playback <ul style="list-style-type: none"> Switching between Single-track repeat and All-track repeat.
INFO	Switching the elapsed time display

Eject CDs

- 1 Press on the main unit while playback is stopped.

Playing tracks in a specific order (Program playback)

Up to 64 tracks can be programmed.

- 1 In the stop mode, press **PROGRAM**.

"PROGRAM" is displayed on the display.

- 2 Use **0 - 9, +10** to select the tracks.

[Example]

To program tracks 3, 12 to play in that order: Press 3, +10 and 2 one after the other.

- 3 Press .

Playback starts in the programmed order.



- The program is cleared when the disc is ejected or the power is turned off.
- In the stop mode, press **CLEAR**, the last track programmed is cleared.



Playing DATA CDs

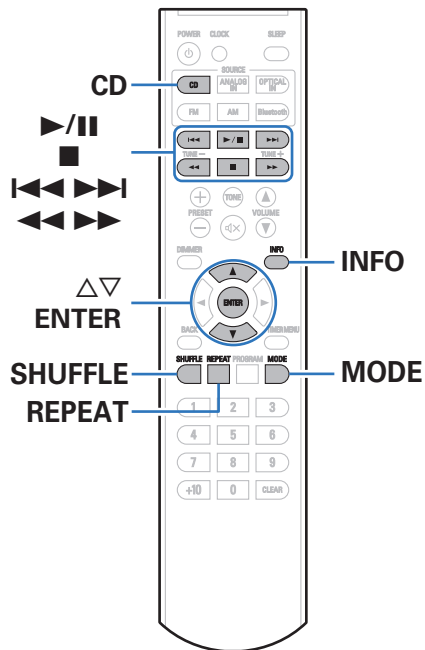

- This section explains how to playback music files that are recorded onto a CD-R or CD-RW.
- There are many music distribution sites on the Internet allowing you to download music files in MP3 or WMA (Windows Media® Audio) format. The music (files) downloaded from such sites can be stored on CD-R or CD-RW discs and played on this unit.
- The audio format types and specifications supported by this unit for playback are as follows.
See “Playable files” for details. (👉 p. 60)
 - MP3
 - WMA

NOTE

- Copyright-protected files cannot be played.
- Note that depending on the software used for burning and other conditions, some files may not play or display correctly.

“Windows Media” and “Windows” are the trademarks or registered trademarks of “Microsoft Corporation” in the United States and other countries.



Playing files

- 1 Press **CD** to switch the input source to “CD”.
- 2 Insert a CD-R or CD-RW containing music files into the disc slot. (🔧 p. 62)
- 3 Use $\Delta \nabla$ to select the folder to be played, then press **ENTER**.
- 4 Use $\lll \ggg$ to select the file to be played, then press **ENTER**.
Playback starts.

Operation buttons	Function
$\blacktriangleright \parallel$	Playback / Pause
\blacksquare	Stop
$\lll \ggg$	File select, Skip to previous track / Skip to next track
$\lll \ggg$	(Press and hold) Fast-reverse / Fast-forward
$\Delta \nabla$	Folder select
MODE	Switch playback mode <ul style="list-style-type: none"> • Switching between playing back all files within the selected folder or all tracks on the disc.
SHUFFLE	Shuffle playback
REPEAT	Repeat playback <ul style="list-style-type: none"> • Switching between Single-track repeat and All-track repeat.
INFO	Switching the Title name, Artist name, Album name, elapsed time display
ENTER	Enter the selected item



- English letters, numbers and certain symbols are displayed. Incompatible characters are displayed as “_”.

■ Files that can be played back

See “Playing back DATA CDs” (🔧 p. 60).



Listening to FM/AM broadcasts

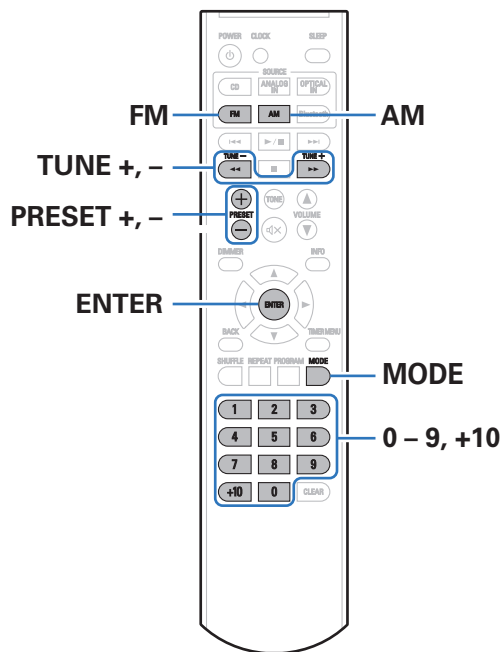

For details about how to connect the antenna, see “Connecting an FM/AM antenna” (🔗 p. 20).

Listening to FM/AM broadcasts

- 1 Press FM or AM to select the reception band.
- 2 Press and hold TUNE + or TUNE - to select the station you want listen to.
Scanning is performed until it finds an available radio station. When it finds a radio station, it stops the scan automatically and tunes in.
 - Press and release TUNE + or TUNE - button to change the frequency one step at a time.



- Press MODE repeatedly while receiving an FM station to switch the FM reception mode between stereo reception mode (STEREO) and monaural reception mode (MONO). If the signal is weak and stable stereo reception is not possible, set “MONO”. “STEREO” is set at the time of purchase.



Presetting FM/AM stations

This unit can be preset with a total of 40 broadcast stations (30 FM stations and 10 AM stations).

- 1 Tune in the station you want to preset.**
- 2 Press ENTER.**
The preset number flashes.
- 3 Use 0 – 9, +10 or PRESET +, – to select the number to be preset, then press ENTER.**
The reception frequency and reception mode are preset.



- Select a number preset in step 3 to overwrite that number with the station currently being received.

Listening to preset stations

- 1 Use 0 – 9, +10 or PRESET +, – to select the preset number.**



Setting the preset channels and changing the received frequency on the main unit

Preset/Tuning buttons (–, +) on the main unit can be used both for switching the preset channel and for tuning. The button functions can be changed by setting the unit to “PRESET” mode or “MANUAL” mode. Follow the steps below to set as desired.

1 Press on the main unit during reception of a station.

The current setting appears on the display.

2 While the current setting is shown on the display, press on the main unit again.

The setting changes each time the button is pressed.

“PRESET” mode:

Use Preset/Tuning buttons (–, +) on the main unit to switch preset channels.

- This is the same operation as PRESET – or PRESET + on the remote control unit.

“MANUAL” mode:

Use Preset/Tuning buttons (–, +) on the main unit to change the received frequency.

- This is the same operation as TUNE – or TUNE + on the remote control unit.
-

About RDS

RDS is a broadcasting service which allows a station to send additional information along with the regular radio program signal.

This unit displays the station name when receiving an FM station compatible with RDS.

Note that the RDS function only works when receiving RDS compatible stations.



Listening to music on a Bluetooth device

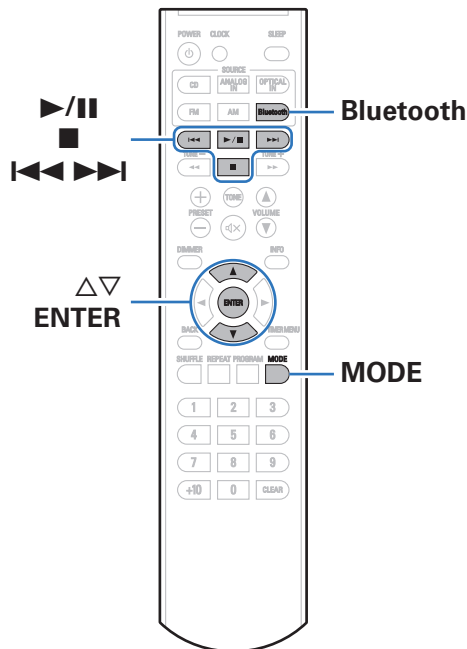

Music files stored on Bluetooth devices such as smartphones, digital music players, etc. can be enjoyed on this unit by pairing and connecting this unit with the Bluetooth device.

Communication is possible up to a range of about 10 m.

NOTE

- To play back music from a Bluetooth device, the Bluetooth device needs to support the A2DP profile.



Listening to music on a Bluetooth device

In order to enjoy music from a Bluetooth device on this unit, the Bluetooth device must first be paired with this unit.

Once the Bluetooth device has been paired, it does not need to be paired again.

1 Press Bluetooth to switch the input source to “BT AUDIO”.

When using for the first time, the unit will go into the pairing mode automatically and “PAIRING” will appear on the display of the unit.

2 Activate the Bluetooth settings on your mobile device.

3 Select this unit when its name appears in the list of devices displayed on the screen of the Bluetooth device.

The Bluetooth indicator lights when pairing is complete.

- Connect to the Bluetooth device while “PAIRING” is being displayed on the display of the unit.
Perform the connection with the Bluetooth device close to the unit (about 1 m).

4 Play music using any app on your Bluetooth device.

- The Bluetooth device can also be operated with the remote control of this unit.
- The next time the input source is switched to “BT AUDIO”, this unit automatically connects to the last Bluetooth device that was connected.





- When this unit's name is not displayed in the screen on the Bluetooth device, search for devices on the Bluetooth device.
- Enter “0000” when the password is requested on the screen of the Bluetooth device.

NOTE

- The pairing mode on this unit lasts for approx. 5 minutes. When the pairing mode on this unit is canceled before the pairing is completed, retry from step 1.
- This unit cannot perform pairing against a Bluetooth device with a pass key other than “0000”.



Operation buttons	Function
	Playback / Pause
	Stop
	Skip to previous track / Skip to next track

NOTE

- To operate the Bluetooth device with the remote control of this unit, the Bluetooth device needs to support the AVRCP profile.
- The remote control of this unit is not guaranteed to work with all Bluetooth devices.
- Depending on the type of Bluetooth device, this unit outputs audio that is coupled to the volume setting on the Bluetooth device.

Pairing with other Bluetooth devices

Pair a Bluetooth device with this unit.

- 1 Activate the Bluetooth settings on your mobile device.**
- 2 Press MODE.**
The Bluetooth menu is displayed on the display.
- 3 Use Δ / ∇ to select “PAIRING”, then press ENTER.**
The Bluetooth indicator blinks and the device will go into the pairing mode.
- 4 Select this unit when its name appears in the list of devices displayed on the screen of the Bluetooth device.**
The Bluetooth indicator lights when pairing is complete.



- This unit can be paired with a maximum of 8 Bluetooth devices. When a 9th Bluetooth device is paired, it will be registered in place of the oldest registered device.
- Enter “0000” when the password is requested on the screen of the Bluetooth device.



Disconnecting from Bluetooth

- 1 Press MODE while connected to Bluetooth.**
The Bluetooth menu is displayed on the display.
- 2 Use $\Delta\nabla$ to select “DISCONNECT”, then press ENTER.**
Disconnect the Bluetooth connection with the connected device.

Setting the Bluetooth standby mode

When Bluetooth standby mode is turned on, the power of this unit automatically turns on when a Bluetooth device connects to this unit while the power of this unit is on standby, enabling you to listen to music via Bluetooth.

- 1 Press Bluetooth to switch the input source to “BT AUDIO”.**
- 2 Press MODE.**
The Bluetooth menu is displayed on the display.
- 3 Use $\Delta\nabla$ to select “BT STBY”, then press ENTER.**
The Bluetooth standby settings menu is displayed on the display.
- 4 Use $\Delta\nabla$ to select the “ON” or “OFF”, then press ENTER.**



- Set “BT STBY” to “ON” and then set this unit to standby. The Bluetooth indicator blinks.
- The Bluetooth standby function cannot be used if there is no pairing information in this unit. To use this function, connect this unit to a paired Bluetooth device.



Reconnecting to this unit from a Bluetooth device

After pairing is completed, the Bluetooth device can be connected without performing any operations on this unit.

This operation also needs to be performed when switching the Bluetooth device for playback.

- 1 If a Bluetooth device is currently connected, deactivate the Bluetooth setting of that device to disconnect it.**
- 2 Activate the Bluetooth setting of the Bluetooth device to be connected.**
- 3 Select this unit from the Bluetooth device list on your Bluetooth device.**
- 4 Play music using any app on your Bluetooth device.**



- When a Bluetooth device is connected with the unit in the Bluetooth standby state (the Bluetooth indicator blinks), the power of the unit will be turned on automatically.



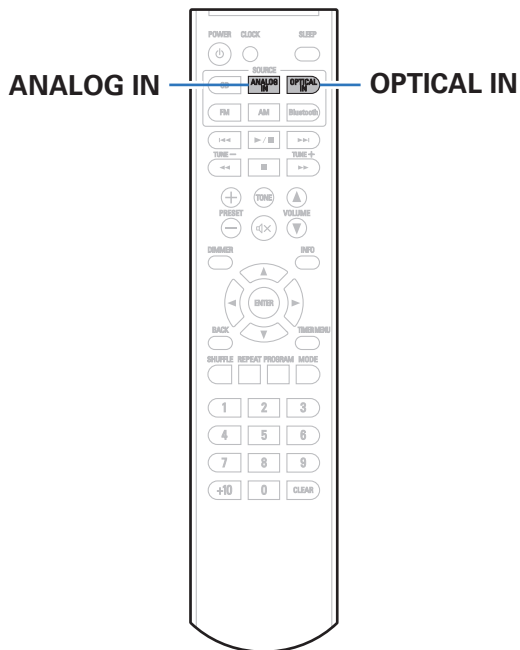

Playing digital input

1 Prepare for playback.

Check the connection, then turn on this units. “Connecting a digital device” (👉 p. 19)

2 Press OPTICAL IN to switch the input source to “OPTICAL”.

3 Play the component connected to this unit.

NOTE

- Do not input non-PCM signals, such as Dolby Digital and DTS. This causes noise and could damage the speakers.
- “UNLOCK” is displayed when audio signals that are not supported by this unit are input, or the sampling frequency cannot be detected.

■ Specifications of supported audio formats

See “DIGITAL IN” (👉 p. 61).



Playing analog input

- 1 Prepare for playback.**
Check the connection, then turn on this unit.
- 2 Press ANALOG IN to switch the input source to “ANALOG”.**
- 3 Play the component connected to this unit.**



Convenience functions

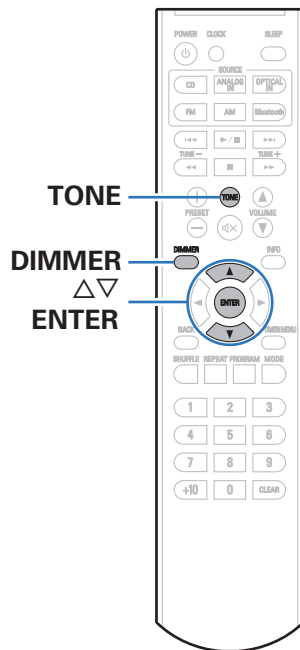

Adjusting the tone 41

Switching the display's brightness 42



Adjusting the tone

1 Press TONE.

This displays the sound quality adjustment menu.

2 Use $\Delta \nabla$ to select the tone parameter to be adjusted.

3 Use $\Delta \nabla$ to adjust the “BASS”, “TREBLE”, “BALANCE” or “S-DIRECT”.

4 Press ENTER.

□ BASS

Adjusts the bass sound.

-10 – +10 (Default : 0)

□ TREBLE

Adjusts the treble sound.

-10 – +10 (Default : 0)

□ BALANCE

Adjust the left/right volume balance.

L1 – L6, CENTER, R1 – R6 (Default : CENTER)



- “BALANCE” settings are not reflected when using headphones.

□ S-DIRECT (Source Direct)

ON:

Playback sound is closer to the source sound.

OFF
(Default):

Disable S-DIRECT (Source Direct) function.



- Set “S-DIRECT” to “ON” to restore “BASS”, “TREBLE” and “BALANCE” to the factory settings.



Switching the display's brightness

The brightness of the display can be adjusted to one of three levels.

1 Press DIMMER.

- The brightness of the display switches each time the button is pressed.



- The display brightness is set to most brightly by default.



■ Contents

Setting the clock, timer playback and sleep timer

Setting the current time	44
Displaying the clock constantly	45
Setting the timer playback	46
Setting the timer playback mode	47
Sleep timer function	47

Setting the Auto Standby mode

Turning Auto Standby mode off	48
Turning Auto Standby mode on	48



Setting the clock, timer playback and sleep timer

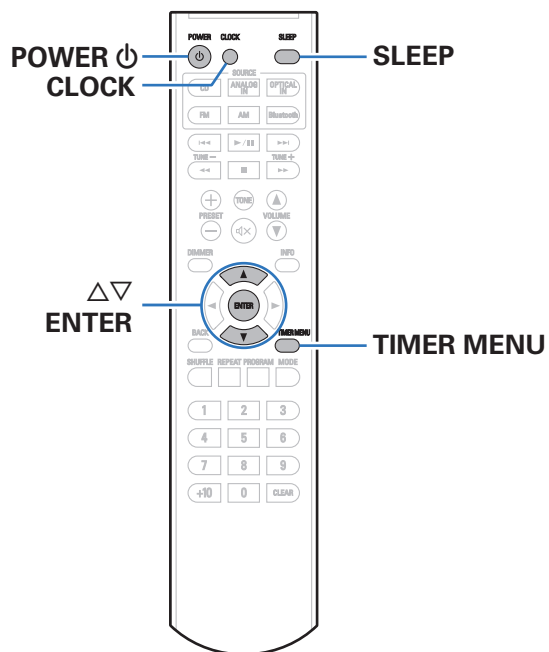

Setting the current time

- 1 Press TIMER MENU.**
The timer setting menu is displayed.
- 2 Use Δ / ∇ to select “CLOCK”, then press ENTER.**
The clock setting menu is displayed.
- 3 Use Δ / ∇ to set the “hours”.**
- 4 Press ENTER.**
The “minutes” display flashes.
- 5 Use Δ / ∇ to set the “minutes”.**
- 6 Press ENTER.**
The current time is set, and the menu display disappears.



❑ Checking the current time when the power is on

Press CLOCK.

Press CLOCK once more and the display returns to its original condition.

❑ Checking the current time when the power is set to standby

Press CLOCK.

The current time is displayed for 10 seconds.



- The time cannot be set when in the standby mode. Turn on the power first.
- When the "CLK MODE" of the timer setting menu is "ON", the current time is continually displayed even when the power is set to standby.

Displaying the clock constantly

Set the clock mode to constantly show the clock in the display even when this unit is on standby.

1 Press TIMER MENU.

The timer setting menu is displayed.

2 Use Δ / ∇ to select "CLK MODE", then press ENTER.

The clock mode setting menu is displayed.

3 Use Δ / ∇ to select the "ON" or "OFF", then press ENTER.



- When "CLK MODE" is set to "ON", this unit consumes the same amount of power as when it is turned on.



Setting the timer playback

Audio from the set input source can be played back at a specified time. Audio can also be played at the same time every day.

1 Press **TIMER MENU**.

The timer setting menu is displayed.

2 Use $\Delta\nabla$ to select **“ALARM”**, then press **ENTER**.

The timer playback setting menu is displayed.

3 Use $\Delta\nabla$ to change to desired setting, then press **ENTER** to enter the setting.

① ON TIME

Use $\Delta\nabla$ to select “hours” for the alarm start time, then press **ENTER**.

Use $\Delta\nabla$ to select “minutes” for the alarm start time, then press **ENTER**.

② OFF TIME

Use $\Delta\nabla$ to select “hours” for the alarm stop time, then press **ENTER**.

Use $\Delta\nabla$ to select “minutes” for the alarm stop time, then press **ENTER**.

③ SOURCE SELECT

Use $\Delta\nabla$ to select the source, then press **ENTER**.

CD / FM / AM

④ MODE SELECT

Use $\Delta\nabla$ to select the alarm mode, then press **ENTER**.

ONCE: Playback starts and stops (the power turns off) once only at the set times.

EVERY: Playback starts and stops (the power turns off) at the set times each day.

4 Press **POWER** ϕ to set the power to standby.

Alarm standby mode is set, and the power indicator lights orange.



Setting the timer playback mode

Turn the timer playback set in “ALARM” in the timer settings menu on (once or daily) or off.

- 1 Press TIMER MENU.**
The timer setting menu is displayed.
- 2 Use Δ / ∇ to select “ON/OFF”, then press ENTER.**
The timer playback mode setting menu is displayed.
- 3 Use Δ / ∇ to select the “ONCE”, “EVERY” or “OFF”, then press ENTER.**
 - When set to “OFF”, time operation is disabled, but the alarm settings remain unchanged.

Sleep timer function

You can have the power automatically switched to standby once a set time has elapsed. This is convenient for listening while going to sleep.

- 1 Press SLEEP during playback and select the setting time.**
 - You can set the sleep timer in the range from 10 to 90 minutes in steps of 10 minutes.

■ To cancel the sleep timer

Press SLEEP to set “OFF”.



- The sleep timer setting is canceled when the unit switches to standby mode.
- To check the time remaining until the sleep timer is activated, press SLEEP.



Setting the Auto Standby mode

When Auto standby mode is set to On, if there is no input signal and operation for 15 minutes, this unit automatically enters standby mode. At time of purchase, this mode is set to On.

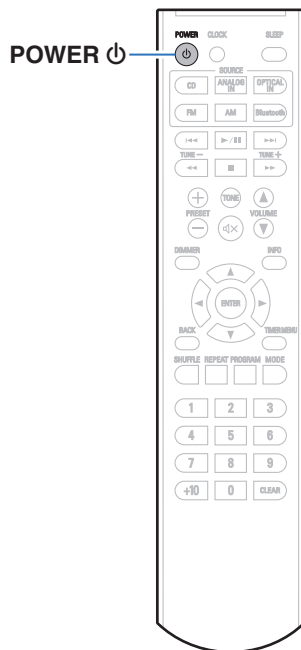

Turning Auto Standby mode off

- 1 Press and hold **POWER**  for more than 3 seconds to turn the Auto Standby mode off.

“AUTO STANDBY OFF” is displayed on the display.

Turning Auto Standby mode on

- 1 Press and hold **POWER**  for more than 3 seconds to turn the Auto Standby mode on.

“AUTO STANDBY ON” is displayed on the display.



- The Auto standby function does not operate when the input source is “FM” or “AM”.



■ Contents

Tips

I want to turn on power to this unit from a Bluetooth device	50
I want to adjust the tone myself	50
I want sound playback that is faithful to the original sound	50
I want to display the clock constantly	50

Troubleshooting

Power does not turn on / Power is turned off	51
LED is flashing	52
Operations cannot be performed through the remote control unit	53
No sound comes out	54
Desired sound does not come out	55
Audio from digital devices cannot be played back (Optical)	55
Sound is interrupted or noise occurs	56
Cannot playback Discs	57
Bluetooth cannot be played back	58



Tips

I want to turn on power to this unit from a Bluetooth device

- Once you perform pairing between this unit and a Bluetooth device, you can turn on power to this unit by operating the Bluetooth device. When Bluetooth standby mode is turned on, the power of this unit turns on when this unit is selected in the device list of a Bluetooth device.

I want to adjust the tone myself

- Press the TONE button and set “BASS”, “TREBLE” and “BALANCE”. (👉 p. 41)

I want sound playback that is faithful to the original sound

- Press the TONE button and set “S-DIRECT” to “ON”. (👉 p. 41)

I want to display the clock constantly

- The clock can be constantly displayed by pressing the TIMER MENU button and setting “CLK MODE” to “ON”. (👉 p. 45)



Troubleshooting



If a problem should arise, first check the following.

1. **Are the connections correct?**
2. **Is the set being operated as described in the owner's manual?**
3. **Are the other devices operating properly?**

If this unit does not operate properly, check the items listed in the table below.

Should the problem persist, there may be a malfunction. In this case, disconnect the power immediately and contact your store of purchase.

■ Power does not turn on / Power is turned off

Symptom	Cause / Solution	Page
Power does not turn on.	• Check whether the power plug is correctly inserted into the power outlet.	<u>22</u>
	• This unit is in standby mode. Press  on the unit or POWER  on the remote control.	<u>24</u>
Power automatically turns off.	• The sleep timer is set. Turn on the power again.	<u>47</u>
	• The unit is set to Auto standby mode. The Auto standby mode automatically switches the unit to standby if there is no signal and no operations are performed for more than 15 minutes. To disable Auto standby mode, press and hold the POWER  button on the remote control for more than 3 seconds when the Auto standby mode is enabled.	<u>48</u>



■ LED is flashing

Symptom	Cause / Solution	Page
The lamp blinks in red in 0.25-second intervals and “PROTECT” appears in the display.	<ul style="list-style-type: none"> Protection circuit activated due to a rise in internal temperature. Turn off the power, wait for the set to fully cool down, then turn the power back on. If the issue is not resolved after trying this solution, disconnect the power of this unit and contact the repair center. 	<u>66</u>
	<ul style="list-style-type: none"> Core wires of two speakers are touching each other or a core wire is sticking out of the terminal and touching the set’s rear panel, activating the protection circuit. First unplug the power cord, then twist the core wires tightly or terminate the speaker cables, then reconnect. If the issue is not resolved after trying this solution, disconnect the power of this unit and contact the repair center. 	<u>66</u>



■ Operations cannot be performed through the remote control unit

Symptom	Cause / Solution	Page
Operations cannot be performed through the remote control unit.	• Batteries are worn out. Replace with new batteries.	<u>6</u>
	• Operate the remote control unit within a distance of about 7 m from this unit and at an angle of within 30°.	<u>6</u>
	• Remove any obstacle between this unit and the remote control unit.	—
	• Insert the batteries in the proper direction, checking the ⊕ and ⊖ marks.	<u>6</u>
	• The set's remote control sensor is exposed to strong light (direct sunlight, inverter type fluorescent bulb light, etc.). Move the set to a place in which the remote control sensor will not be exposed to strong light.	—
	• When using a 3D video device, the remote control unit of this unit may not function due to effects of infrared communications between units (such as TV and glasses for 3D viewing). In this case, adjust the direction of units with the 3D communications function and their distance to ensure they do not affect operations from the remote control unit of this unit.	—



■ No sound comes out

Symptom	Cause / Solution	Page
No sound comes out of speakers.	• Check the connections for all devices.	<u>16</u>
	• Insert connection cables all the way in.	—
	• Check that input connectors and output connectors are not reversely connected.	—
	• Check cables for damage.	—
	• Check that speaker cables are properly connected. Check that cable core wires come in contact with the metal part on speaker terminals.	<u>17</u>
	• Securely tighten the speaker terminals. Check speaker terminals for looseness.	<u>17</u>
	• Check that a proper input source is selected.	<u>25</u>
	• Adjust the volume.	<u>25</u>
	• Cancel the mute mode.	<u>25</u>
	• Check the digital audio output setting on the connected device. The initial settings may be off depending on the device.	—
	• Do not input non-PCM signals, such as Dolby Digital and DTS. This causes noise and could damage the speakers.	<u>38</u>
	• No sound is output from the speakers when headphones are connected.	<u>10</u>
• To playback via a Bluetooth connection, perform pairing between this unit and the Bluetooth device.	<u>34</u>	



■ Desired sound does not come out

Symptom	Cause / Solution	Page
Left/right volume balance is unbalanced.	<ul style="list-style-type: none"> Press the TONE button on the remote control to adjust the "BALANCE". 	41
Set values are not reflected in "BASS" and "TREBLE".	<ul style="list-style-type: none"> Press the TONE button and set "S-DIRECT" to "OFF". 	41
Set values are not reflected in "BALANCE".	<ul style="list-style-type: none"> "BALANCE" settings are not reflected when using headphones. 	41

■ Audio from digital devices cannot be played back (Optical)

Symptom	Cause / Solution	Page
"UNLOCK" is displayed.	<ul style="list-style-type: none"> When digital audio signals cannot be detected properly, "UNLOCK" is displayed. 	38
	<ul style="list-style-type: none"> "UNLOCK" is displayed when audio signals that are not supported by this unit are input. Check the audio output signal format from your digital device. 	38



■ Sound is interrupted or noise occurs

Symptom	Cause / Solution	Page
When making a call on iPhone, noise occurs in audio output on this unit.	<ul style="list-style-type: none"> When making a call, keep a distance of 20 cm or longer between iPhone and this unit. 	—
Noise often occurs in FM/AM broadcasting.	<ul style="list-style-type: none"> Change the antenna orientation or position. 	<u>20</u>
	<ul style="list-style-type: none"> Use an outdoor antenna. 	<u>20</u>
	<ul style="list-style-type: none"> Separate the antenna from other connection cables. 	<u>20</u>
During playback from the CD-R/CD-RW, sound is occasionally interrupted.	<ul style="list-style-type: none"> This may be caused by poor recording conditions, or the disc itself may be of poor quality. Use a correctly recorded disc. 	—



■ Cannot playback Discs

Symptom	Cause / Solution	Page
Cannot playback when the ►/ button is pressed, or cannot correctly play back a specific part of the disc.	<ul style="list-style-type: none"> The disc is dirty or scratched. Either clean the disc, or insert a different disc. 	<u>62</u>
Cannot playback CD-R/CD-RW.	<ul style="list-style-type: none"> CDs cannot be played back unless they have been finalized. Use a finalized disc. 	<u>62</u>
	<ul style="list-style-type: none"> This may be caused by poor recording conditions, or the disc itself may be of poor quality. Use a correctly recorded disc. 	—
	<ul style="list-style-type: none"> The DATA CD playback function of this unit only supports playback of MP3 and WMA files. 	<u>60</u>
“DISC ERR” is displayed.	<ul style="list-style-type: none"> “DISC ERR” is displayed if a disc that cannot be played is loaded. 	<u>62</u>
	<ul style="list-style-type: none"> “DISC ERR” is displayed if the disc is loaded upside-down or if no disc is loaded. 	<u>62</u>



■ Bluetooth cannot be played back

Symptom	Cause / Solution	Page
Bluetooth devices cannot be connected to this unit.	• The Bluetooth function in the Bluetooth device has not been enabled. See the Owner's Manual of the Bluetooth device to enable the Bluetooth function.	—
	• Bring the Bluetooth device near to this unit.	—
	• The Bluetooth device cannot connect with this unit if it is not compatible with the A2DP profile.	—
	• Turn the power of the Bluetooth device off and on again, and then try again.	—
	• The Bluetooth function is off. Press Bluetooth button, activate the Bluetooth function and connect again.	37
The sound is cut off.	• Bring the Bluetooth device near to this unit.	—
	• Remove obstructions between the Bluetooth device and this unit.	—
	• To prevent electromagnetic interference, locate this unit away from microwave ovens, wireless LAN devices and other Bluetooth devices.	—
	• Reconnect the Bluetooth device.	—



Resetting factory settings

Perform this procedure if the display is abnormal or if operations cannot be performed.

Various settings are reset to the factory default values. Make settings again.

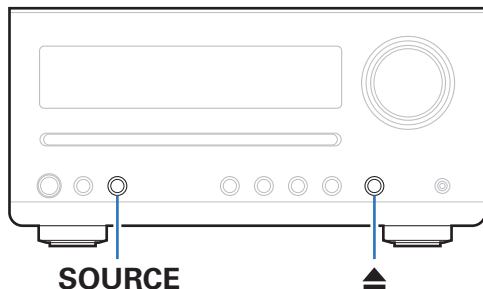

- 1** Press **CD** on the remote control unit to switch the input source to “CD”.
- 2** Press **▲** to eject a disc.
- 3** While pressing and holding **▲**, press and hold **SOURCE** for 5 seconds.
The “RESET” is displayed.



- Repeat this process if “RESET” is not displayed.



Playing back DATA CDs

■ DATA CDs formats

CD-R and CD-RW discs created in the format described below can be played.

Writing software format

ISO9660 level 1

When written in other formats, it may not be possible to play the disc properly.

Maximum number of playable files and folders

Number of files : 999

Maximum number of folders : 255

File format

MPEG-1 Audio Layer-3

WMA (Windows Media Audio)

Tag data

ID3-Tag (Ver. 1.x and 2.x)

META-Tag (Compatible with title, artist and album names)

■ Playable files

	Sampling frequency	Bit rate	Extension
MP3	32/44.1/48 kHz	32 – 320 kbps	.mp3
WMA	32/44.1/48 kHz	32 – 480 kbps	.wma



- Be sure to give files the extension “.MP3” or “.WMA”. Files with any other extensions or files with no extensions cannot be played.
- Mac OS X files assigned with filenames that begin with “_” are not music data and cannot be played back.
- In accordance with copyright laws, recordings you have made should only be used for your personal enjoyment and may not be used in other ways without permission of the copyright holder.



DIGITAL IN

■ Specifications of supported audio formats

□ Optical

	Sampling frequency	Bit length
Linear PCM (2-channel)	32/44.1/48/88.2/96 kHz	16/24 bits

Playing back Bluetooth devices

This unit supports the following Bluetooth profiles.

- A2DP (Advanced Audio Distribution Profile) :
When a Bluetooth device that supports this standard is connected, monaural and stereo sound data can be streamed at a high quality.
- AVRCP (Audio/Video Remote Control Profile) :
When a Bluetooth device that supports this standard is connected, the Bluetooth device can be operated from this unit.

■ About Bluetooth communications

Radio waves broadcast from this unit may interfere with the operation of medical devices. Make sure you turn off the power of this unit and Bluetooth device in the following locations as radio wave interference may cause malfunctions.

- Hospitals, trains, aircraft, petrol kiosks and places where flammable gases are generated
- Near automatic doors and fire alarms



About Discs

Discs playable on this unit

1 Music CDs

Discs marked with the logo below can be played in this unit.



2 CD-R/CD-RW

NOTE

- Discs in special shapes (heart-shaped discs, octagonal discs, etc.) cannot be played. Do not attempt to play them, as doing so can damage the unit.
- Some discs and some recording formats cannot be played.
- Non-finalized discs cannot be played.
- If the unit is left in a room full of smoke from cigarettes, etc., for long periods of time, the surface of the optical pickup may get dirty, preventing it from receiving signals properly.



Loading discs

- Place the disc in the tray, label side up.
- Insert the disc into the disc slot slowly. Release your hand once the disc is drawn in.



- "DISC ERR" is displayed if a disc that cannot be played is loaded.
- "DISC ERR" is displayed if the disc is loaded upside-down or if no disc is loaded.

NOTE

- Do not place any foreign objects in the disc slot. Doing so could result in damage.
- If the unit is left in a room full of smoke from cigarettes, etc., for long periods of time, the surface of the optical pickup may get dirty, preventing it from receiving signals properly.



■ Cautions on loading discs

- 8 cm discs cannot be used on this unit. Do not insert 8 cm discs into the disc slot.
- Do not use an 8 cm disc adapter.
- Only load one disc at a time. Loading two or more discs can damage the unit or scratch the discs.
- Do not use cracked or warped discs or discs that have been repaired with adhesive, etc.
- Do not use discs on which the sticky part of cellophane tape or labels is exposed or on which there are traces of where labels have been removed. Such discs can get caught inside the player and damage it.

■ Cautions on handling

- Do not get fingerprints, oil or dirt on discs.
- Take special care not to scratch discs when removing them from their cases.
- Do not bend or heat discs.
- Do not enlarge the hole in the center.
- Do not write on the labeled (printed) surface with ball-point pens, pencils, etc., or stick new labels on discs.
- Water droplets may form on discs if they are moved suddenly from a cold place (outdoors for example) to a warm place, but do not try to dry them off using a hairdryer, etc.

■ Cautions on storing discs

- Be sure to remove discs after using them.
- Be sure to store discs in their cases to protect them from dust, scratches, warping, etc.
- Do not store discs in the following places:
 1. Places exposed to direct sunlight for long periods of time
 2. Dusty or humid places
 3. Places exposed to heat from heaters, etc.

■ Cleaning discs

- If there are fingerprints or dirt on a disc, wipe them off before using the disc. Fingerprints and dirt can impair sound quality and cause interruptions in playback.
- Use a commercially available disc cleaning set or a soft cloth to clean discs.



Gently wipe the disc from the inside towards the outside.

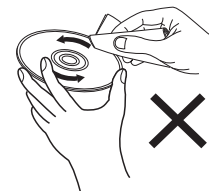

Do not wipe with a circular motion.

NOTE

- Do not use record spray, antistatic agents, benzene, thinner or other solvents.



Last function memory

This stores the settings as they were immediately before going into the standby mode.

When the power is turned back on, the settings are restored to as they were immediately before going into the standby mode.



Explanation of terms

■ Audio

MP3 (MPEG Audio Layer-3)

This is an internationally standardized audio data compression scheme, using the “MPEG-1” video compression standard. It compresses the data volume to about one eleventh its original size while maintaining sound quality equivalent to a music CD.

WMA (Windows Media Audio)

This is audio compression technology developed by Microsoft Corporation.

WMA data can be encoded using Windows Media® Player. To encode WMA files, only use applications authorized by Microsoft Corporation. If you use an unauthorized application, the file may not work properly.

Sampling frequency

Sampling involves taking a reading of a sound wave (analog signal) at regular intervals and expressing the height of the wave at each reading in digitized format (producing a digital signal).

The number of readings taken in one second is called the “sampling frequency”. The larger the value, the closer the reproduced sound is to the original.

Speaker impedance

This is an AC resistance value, indicated in Ω (ohms). Greater power can be obtained when this value is smaller.

Bit rate

This expresses the read amount per 1 second of video/audio data recorded. A larger number means higher sound quality, but also means a larger file size.



■ Others

Finalizing

Finalization is the process that makes recorded CD-R/CD-RW discs playable on compatible players.

Pairing

Pairing (registration) is an operation that is required in order to connect a Bluetooth device to this unit using Bluetooth. When paired, the devices authenticate each other and can connect without mistaken connections occurring.

When using Bluetooth connection for the first time, you need to pair this unit and the Bluetooth device to be connected.

Protection circuit

This is a function to prevent damage to devices within the power supply when an abnormality such as an overload, excess voltage occurs or over temperature for any reason.

Trademark information



The Bluetooth® word mark and logos are registered trademarks owned by Bluetooth SIG, Inc. and any use of such marks by D&M Holdings Inc. is under license. Other trademarks and trade names are those of their respective owners.



Specifications

■ Audio amplifier

- CD player

Playable frequency response:	2 Hz - 20 kHz
Wow & flutter:	Below measurable limits (± 0.001 %)
Sampling frequency:	44.1 kHz

- Audio amplifier

Rated output:	2-channel 15 W + 15 W (6 Ω /ohms, 1 kHz, T.H.D. 10 %)
----------------------	---

■ Tuner section

	[FM]	[AM]
Receiving Range:	87.50 MHz – 108.00 MHz	522 kHz – 1611 kHz
Effective sensitivity:	2.5 μ V / 75 Ω /ohms	20 μ V
FM STEREO separation:	30 dB (1 kHz)	
FM S/N ratio:	Monaural : 65 dB Stereo : 60 dB	
FM THD+N (1 kHz):	Monaural : 0.2 % Stereo : 0.5 %	



■ Bluetooth section

Communications system:	Bluetooth Version 4.0
Transmission power:	Power Class 2
Maximum communication range:	Approx. 10 m in line of sight*
Frequency band:	2.4 GHz band
Modulation scheme:	FHSS (Frequency-Hopping Spread Spectrum)
Supported profiles:	A2DP (Advanced Audio Distribution Profile) 1.2 AVRCP (Audio Video Remote Control Profile) 1.4
Corresponding codec:	SBC, AAC
Transmission range (A2DP):	20 Hz – 20,000 Hz

*The actual communication range varies depending on the influence of such factors as obstructions between devices, electromagnetic waves from microwave ovens, static electricity, cordless phones, reception sensitivity, antenna performance, operating system, application software etc.



■ Clock/Alarm/Sleep

Clock type:	Crystal oscillator (Within 1 – 2 minutes per month)
Alarm:	Once alarm/Everyday alarm: One system each
Sleep:	Sleep timer: Max. 90 minutes

■ General

Operating temperature:	+5 °C - +35 °C
Power supply:	AC 230 V, 50/60 Hz
Power consumption:	30 W
Power consumption in clock mode :	7 W
Power consumption in standby mode :	0.3 W
Power consumption in Bluetooth standby mode :	0.4 W

- For purposes of improvement, specifications and design are subject to change without notice.



■ Dimensions

Unit : mm

【 Main unit 】

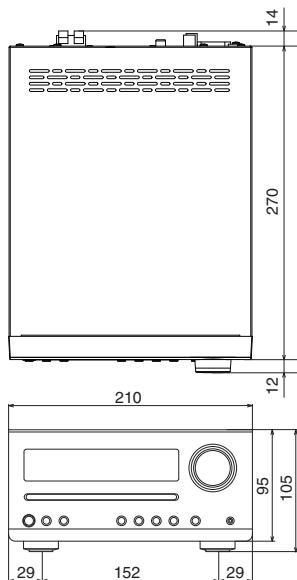

【 Speaker 】

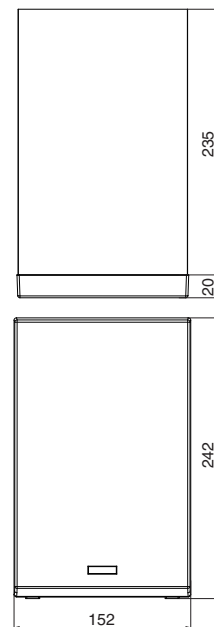

■ Weight

Main unit: 2.8 kg

Speaker (single unit): 3.4 kg



Index

A	
Adjusting the tone	41
Alarm	46
Auto Standby	48
B	
Bluetooth device	33
C	
CD	26
D	
DATA CD	28
Display's brightness	42
F	
FM/AM antenna	20, 30
FM/AM broadcasts	20, 30
Front panel	8
M	
Muting	25
R	
Rear panel	11
Remote control unit	13
Resetting factory settings	59
S	
Sleep timer	47
Speakers	17
T	
Tips	50
Troubleshooting	51
V	
Volume	25



DENON[®]

www.denon.com

3520 10642 00AD

Copyright ©2018 D&M Holdings Inc. All Rights Reserved.